

YAESU
The radio

C4FM/FM 144/430MHz
DIGITAL/ANALOG TRANSCEIVER

FT-70DR

FT-70DE

Operating Manual



Contents

Introduction	1	VFO Scan	27
Quick Guide	2	Memory Channel Scanning	27
Controls & Connections	3	Setting the Receive Operation When Scanning Stops ...	28
Transceiver	3	Weather Alert Scan (USA version only).....	28
The Keypad Functions	5	Skip Memory Channel and Specified Memory Channel ...	29
Display	6	Programmable Memory scan (PMS)	29
Safety Precautions (Be Sure to Read)	8	Dual Receive (DW) feature	29
About this manual	11	Using the WIRES-X Function	30
Supplied Accessories and Options	11	WIRES-X feature	30
Supplied Accessories	11	Connecting to a WIRES-X node	
Available Options	11	in the C4FM mode (*Recommended) ...	30
Preparation	12	Connect and communicate with WIRES-X in analog mode ...	33
Installing the Antenna	12	Disconnecting from the node or room	33
Attaching the Belt Clip	12	Convenient Functions	34
Installing the Battery Pack	12	Tone squelch feature	34
Removing the Battery Pack	12	Digital Code squelch (DCS) feature	34
Charging the Battery Pack	13	New PAGER (EPCS) feature	34
Charging the Battery Pack using the Battery Charger ...	13	Digital Personal ID (DP-ID) feature	34
Charging the Battery Pack using the Rapid Charger (SBH-28) ...	13	Using Set Mode	35
External Power Supply	13	Display and Key Lamp Dimmer	35
Connecting an External Power Supply for Use in Vehicle ...	13	Changing the Beep Volume	35
Connecting to an External Power Supply Using a Power Cable ...	13	Automatic Power OFF (APO)	35
Operation	14	Time Out Timer (TOT)	35
Turning the Transceiver ON	14	Busy Channel Lock-Out (BCLO)	35
Adjusting the Volume Level	14	Receiver Battery Save Function	35
Adjusting the squelch setting	15	Password Feature	35
Selecting a Frequency Band	15	Tables of Set Mode Operations	36
Tuning to a Frequency	15	Restoring to Defaults (Reset)	38
Changing the Frequency Step	15	All Reset	38
Selecting the Communication Mode	16	Set Mode Reset	38
Using AMS (Automatic Mode Select) function ...	16	Specifications	39
Fixing the Communication Mode	17		
Transmission	17		
Changing the Transmission Power Level	18		
Locking Keys and DIAL knob	18		
Programmable key function	18		
Using the convenient Digital C4FM feature	19		
About the Digital Group ID (DG-ID) feature	19		
Communicating with the DG-ID feature	19		
Setting the transmit and receive DG-ID number to			
"00" for communicating with all other stations			
using C4FM digital mode ...	19		
Communicating only with the specific members			
by setting the DG-ID number except for "00" ...	20		
About the GM(Group Monitor) feature	21		
Displaying the information of the other			
station received by GM (Group Monitor) function ...	22		
Repeater Operation	23		
Communicating Via the Repeater	23		
Tone Calling (1750 Hz burst tone)	23		
Using the Memory	24		
Registering to Memory Channels	25		
Recalling a Memory Channel	25		
Clearing Memories	26		
Recalling the Home Channels	26		
Changing the Home Channel Frequency	26		
Split Memory	26		
Using Memory Tag	26		
Using Memory Bank	26		
Scanning Function	27		

Thank you for purchasing this Yaesu product.

- The **FT-70DR/FT-70DE** is a handheld transceiver for operation in the 144 MHz and 430 MHz Amateur radio bands. It is compatible with the Analog FM and C4FM modes.
- The **FT-70DR/FT-70DE** is rugged and compact (W60 × H98 × D33 mm (2.36" × 3.86" × 1.30")) providing splash, water, and dust resistant features conforming to IP54 for mobile and field operation.
- The AMS (Automatic Mode Select) feature automatically selects the analog FM and C4FM digital modes, according to the signal of the other station.
- With the GD-ID (Digital Group ID) feature (📖19), the Group Monitor (GM) feature enables automatically locating, and communicating with other stations that have the same DG-ID number within contact range, by utilizing a matching group ID number from 00 to 99.
- The Digital Personal ID (DP-ID) feature may communicate only by the transceivers registered the individual ID information that is different for each transceiver included in the transmission radio wave of C4FM digital communication.
- ☐ Compatible with analog FM mode and C4FM digital modes..... 📖16
- ☐ Equipped with AMS (Automatic Mode Select) Feature 📖16
- ☐ The DG-ID function automatically checks to find if there are any stations with the GM function in operation on the same frequency within communication range 📖19
- ☐ The DP-ID feature may recall/standby only the other stations that are set with the C4FM Digital transceiver specific number. 📖34
- ☐ High-brightness LED for easy viewing of the MODE/STATUS indicator 📖4
- ☐ Supports Yaesu WIRES-X Internet linking, enabling communication with remote partners via the Internet 📖30
- ☐ Dustproof and water-splash-resistant design, equivalent to IPX54, which protects the transceiver from dust and splashes 📖10
- ☐ Wide-band reception over the range of 108.000 MHz to 579.995 MHz 📖15
- ☐ A wide variety of scan features 📖27
- ☐ A variety of individual selective calling functions; such as tone squelch (CTCSS) and DCS functions 📖34
- ☐ Large-capacity 999 memory channels 📖24
- ☐ 6 home channels and 50 pairs of PMS memory channels 📖26, 📖29
- ☐ Create mnemonic tags for memory channels and Home channel 📖26
- ☐ Connecting to an external power supply..... 📖4
- ☐ Automatic power off (APO) feature turns the transceiver OFF after a preset time period 📖35
- ☐ Data terminal (Mini USB) for connection to a PC and firmware updates 📖4

We urge you to read this manual in its entirety, and also the Advance Manual (available for download on the Yaesu website), to gain a full understanding of the amazing capability of the exciting new **FT-70DR/FT-70DE** Transceiver.

Names and display of Controls



Normal operation (VFO Mode)

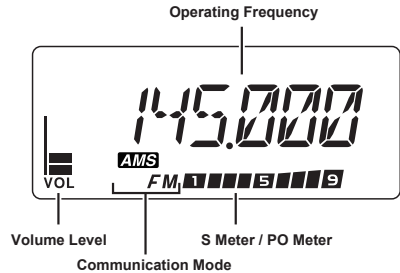

① Turning the Power ON

Install the charged battery pack and then press and hold the switch.

② Inputting the Call sign

When turning the power ON for the first time after purchasing, input the call sign of your own station. Input call sign may be changed from the Set Mode [64* (63) MY-CALL][37]. *:USA Version.

1. When turning the power ON for the first time after purchasing, the call sign input screen will be displayed.



2. Press the .

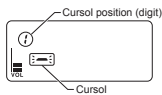

3. Input the call sign.

- Rotate the to select each character.
- Press the key to move the cursor to the right.

4. Repeat step 3 to input the remaining call sign characters.

- Press key to move the cursor to the left.
- Press and hold the key to erase all characters after the cursor.

5. Press the PTT () switch to conclude inputting.

Normal operation (VFO Mode) screen will be displayed

③ Selecting the Operating Band

Press the key.

④ Tuning the frequency

Rotate the .

⑤ Adjusting the volume

While pressing and holding the , rotate the to adjust the volume to a comfortable level.

⑥ Adjusting the squelch setting

The squelch level may be adjusted to mute the background noise when no signal is received.

1. Press the key, and then press the key.
2. Rotate the to adjust the squelch to a level at which the background noise is muted.

* When the squelch level is increased, the noise is more likely to be silenced, but it may become more difficult to receive weak signals.

3. Press the PTT () switch to save the setting.

⑦ Selecting the Communication Mode

The communication mode is automatically selected to correspond to the signal being received.

Press the key to manually select the communication mode (17).

⑧ Transmitting/Receiving Signals

● Transmitting

While pressing and holding the PTT () switch, speak into the microphone.

● Receiving

Release the to return to receive mode.

Transceiver

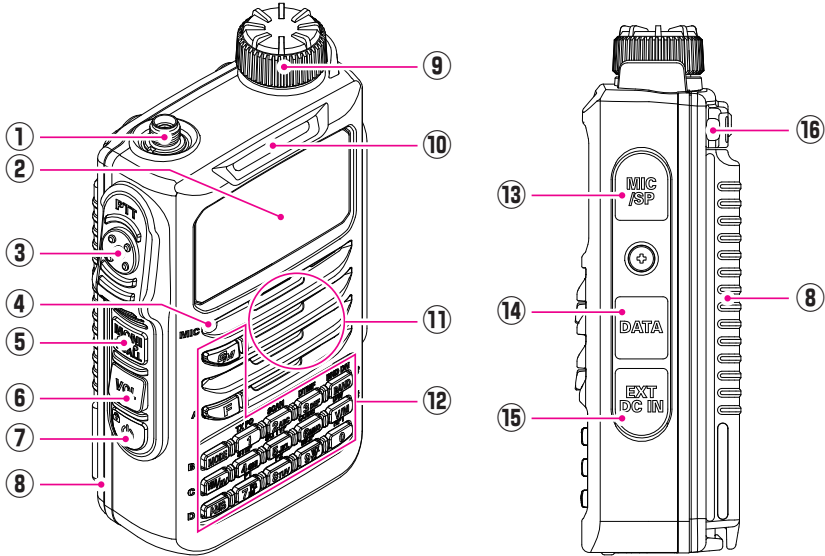

①	Antenna Jack (SMA)* (□12)
②	LCD (Liquid Crystal Display) (□6) The display shows the current operating conditions.
③	PTT Switch (□17) • Press and hold the PTT switch to transmit, and release it to receive. • In the Set mode, press the PTT switch to save the new setting and return to normal operation.
④	Microphone (□17)
⑤	MONI/T.CALL Switch USA/Asian version Press the MONI/T.CALL switch to open the squelch. European version Press the MONI/T.CALL switch to activates the T-CALL(1750 Hz). Regarding the current operating mode, both the analog FM and C4FM may monitor the received audio signal. Press the [F] key → press the MONI/T-CALL switch and then rotate the DIAL knob to adjust the squelch.
⑥	VOL Switch (□14) While pressing and holding the VOL switch, rotate the DIAL knob to adjust the audio volume level.
⑦	Power (Lock) Switch (□14, □18) • When the power is OFF , press and hold this switch to turn the Power ON . When the power is ON , press and hold the switch again to turn the Power OFF . • When the power is ON , press this button briefly to engage, or release the key lock.
⑧	Battery pack* (□12)

⑨	<p>DIAL Knob (📖15)</p> <ul style="list-style-type: none"> • Rotate the DIAL Knob to change the frequency or select a memory channel. • While pressing and holding the VOL Switch, rotate the DIAL knob to adjust the audio volume level. • Rotate the DIAL Knob to select the desired entry for set mode. 																										
⑩	<p>MODE/STATUS Indicator</p> <p>Indicates the transmit/receive status, and the communication mode with the high brightness LED.</p> <table border="1" data-bbox="138 331 990 683"> <thead> <tr> <th colspan="2">Communication status</th> <th>Left portion</th> <th>Right portion</th> </tr> </thead> <tbody> <tr> <td rowspan="4">Receiving</td> <td>Analog FM mode</td> <td rowspan="4">Green</td> <td>Green</td> </tr> <tr> <td>Digital C4FM mode</td> <td>Blue</td> </tr> <tr> <td>Digital Data</td> <td>White</td> </tr> <tr> <td>Receiving signals with unmatched DG-ID, DP-ID, tone frequency or DCS code</td> <td>Blink in blue</td> </tr> <tr> <td rowspan="2">Transmitting</td> <td>Analog FM mode</td> <td rowspan="2">Red</td> <td>Red</td> </tr> <tr> <td>Digital C4FM mode</td> <td>Blue</td> </tr> <tr> <td rowspan="2">GM function during operation</td> <td>The other station is within the communication range</td> <td rowspan="2">—</td> <td>Light Blue</td> </tr> <tr> <td>Transmitting GM confirmation signal to the other station within the communication range</td> <td>Blue</td> </tr> </tbody> </table>	Communication status		Left portion	Right portion	Receiving	Analog FM mode	Green	Green	Digital C4FM mode	Blue	Digital Data	White	Receiving signals with unmatched DG-ID, DP-ID, tone frequency or DCS code	Blink in blue	Transmitting	Analog FM mode	Red	Red	Digital C4FM mode	Blue	GM function during operation	The other station is within the communication range	—	Light Blue	Transmitting GM confirmation signal to the other station within the communication range	Blue
Communication status		Left portion	Right portion																								
Receiving	Analog FM mode	Green	Green																								
	Digital C4FM mode		Blue																								
	Digital Data		White																								
	Receiving signals with unmatched DG-ID, DP-ID, tone frequency or DCS code		Blink in blue																								
Transmitting	Analog FM mode	Red	Red																								
	Digital C4FM mode		Blue																								
GM function during operation	The other station is within the communication range	—	Light Blue																								
	Transmitting GM confirmation signal to the other station within the communication range		Blue																								
⑪	<p>Speaker</p>																										
⑫	<p>Keypad</p> <p>The functions of the keypad are described in detail on page 5.</p>																										
⑬	<p>MIC/SP jack*</p> <ul style="list-style-type: none"> • Connect a speaker microphone or earpiece microphone to this jack. • Connect the optional Clone Cable (CT-27), to transfer saved data and function settings to another FT-70DR/DE transceiver. <hr/> <p> Do not connect any microphone which is not specified by Yaesu. A malfunction may can result.</p> <ul style="list-style-type: none"> • When an external microphone or cable is connected, the dust and splash protection does not function. 																										
⑭	<p>DATA Terminal*</p> <ul style="list-style-type: none"> • When updating the firmware, connect to a PC using a USB cable. * When a new firmware update for the FT-70DR/DE is available, download the data from the YAESU website to update the FT-70DR/DE to the latest version. * NOTE: the optional camera-equipped microphone (MH-85A11U) is not supported. 																										
⑮	<p>EXT DC IN Jack*(📖13)</p> <ul style="list-style-type: none"> • When charging the battery pack, connect the battery charger to this jack. • Connect an external power supply adapter with a cigarette lighter plug (SDD-13) or an external power cable (E-DC-6) to this jack. 																										
⑯	<p>Strap Hole (📖12)</p>																										

*: When the included antenna and battery pack are installed and the MIC/SP jack, DATA terminal, and EXT DC IN jack are securely covered with rubber caps, the FT-70DR/DE meets the waterproofing performance conforming to IP54.

The Keypad Functions

Key	Primary Function (Press Key)		Secondary Function (Press F + Key)	Third Function (Press and Hold for over one second)
	VFO or Memory Recall	Inputting Memory Tag		
GM	Turns the GM (Group Monitor) function ON/OFF	Press and hold this key to erase all characters after the cursor	—	Turns the GM (Group Monitor) function ON/OFF
F	Activates the “Secondary” key function (F appears)	Press this key to complete memory tag in the Set Mode	Deactivates the “Secondary”key function (F disappears)	Enters the Set mode.
MODE	Selects the receive mode between FM(AM), DN and VW*	Moves the cursor to the left.	Switches between the frequency display and the memory tag display	Sets the DG-ID number
HM/RV	Reverses the transmit and receive frequencies while working through a repeater	—	Recalls the “HOME” (favorite frequency) channel	Overwrites the “HOME” (favorite frequency) channel
AMS	Selects AMS Mode (TX AUT/TX FM/TX DIG)	—	Activates the WIRES-X feature	Activates the AMS feature
BAND (BND DN)	Moves operation to the next-highest frequency band	Moves the cursor to the right	Moves operation to the next-lowest frequency band	—
V/M (DW)	Switches between the VFO mode and the Memory Channel mode	Press and hold this key to complete the memory channel registration	Enables the Dual Receive function	Activates the “Memory Write” mode (for memory channel storage)
1 (TX PO)	Number “1”	Number “1”	Selects the desired transmit power output level.	Enters all the zeros at once after entering the number “1” on inputting the frequency.
2 (SCAN)	Number “2”	Number “2”, or characters “A”, “B”, or “C”	Starts the scanning	Enters all the zeros at once after entering the number “2” on inputting the frequency.
3 (DTMF)	Number “3”	Number “3”, or characters “D”, “E”, or “F”	Selects the DTMF mode.	Enters all the zeros at once after entering the number “3” on inputting the frequency.
4 (STEP)	Number “4”	Number “4”, characters “G”, “H”, or “I”	Selects the frequency steps	Enters all the zeros at once after entering the number “4” on inputting the frequency.
5 (SQ TYP)	Number “5”	Number “5”, characters “J”, “K”, or “L”	Selects the squelch types	Enters all the zeros at once after entering the number “5” on inputting the frequency.
6 (CODE)	Number “6”	Number “6”, or characters “M”, “N”, or “O”	Selects the CTCSS Tone or DCS code	enters all the zeros at once after entering the number “6” on inputting the frequency.
7 (P1)	Number “7”	Number “7”, or characters “P”, “Q”, “R”, or “S”	P1 (programmable key 1)	enters all the zeros at once after entering the number “7” on inputting the frequency.
8 (P2)	Number “8”	Number “8”, or characters “T”, “U”, or “V”	P2 (programmable key 2)	enters all the zeros at once after entering the number “8” on inputting the frequency.
9 (SKIP)	Number “9”	Number “9”, or characters “W”, “X”, “Y”, or “Z”	Selects the Memory Scan “Skip” channel or “Select” channel	enters all the zeros at once after entering the number “9” on inputting the frequency.
0 (RPT)	Number “0”	Number “0”, or symbols“(space)”, “-”, “/”, “?”, or “1”	Selects the direction of the up link frequency shift (either “-”, “+”, or “simplex”) during repeater operation.	enters all the zeros at once after entering the number “0” on inputting the frequency.

*: VW icon is displayed when Set Mode [16 DIG VW] (□ 36) is set to “ON” (the default setting is “OFF”).

Display

Frequency / Memory Tag /
Set Mode Item

Memory Channel Number /
HOME Channel /
Memory Bank Number/
In Range / Out of Range
(GM function)

Volume Bar Graph

Communication Mode
DN: Normal digital mode
VW: Voice wide mode
FM: Analog FM mode
AM: AM mode (Receive only)

S Meter : Displays the received signal strength
PO Meter : Displays the transmit power level

Icon	Description	
GM	Appears when the GM (Group Monitor) function in the digital mode is enabled.	19 22
▶	▶ : Memory channel registered as a skip memory ▶▶▶ : Memory channel registered as a specified memory (with blink)	29
PRI	Priority Memory Channel	29
- +	Repeater Shift Direction Split Memory (a simultaneously)	23 26
T	T : Appears when the tone encoder function in the analog FM mode is enabled.	34
SQ	T SQ : Appears when the tone squelch function in the analog FM mode is enabled.	
DCS	Appears when the DCS function in the analog FM mode is enabled.	34
PAG	Appears when the PAGER function is enabled.	34
	The battery condition is displayed in 4 steps. (No display) : Full battery power : Enough battery power : Battery is depleted. Charge battery. : (When blinking) Charge battery immediately.	13

Icon	Description													
	: Appears when a function key is pressed. : On writing the memory channel, etc.	5 25												
	Appears when the AMS (Automatic Mode Select) function is enabled. It is recommended that AMS function be enabled for normal operations.	16												
LOW	TX Power Level Indicator (LOW/MID TX Power Selected) <table border="1" data-bbox="240 347 909 499"> <thead> <tr> <th>Tx Power</th> <th>Icon</th> <th>TX Power Meter during transmission</th> </tr> </thead> <tbody> <tr> <td>HIGH (5 W)</td> <td>(No display)</td> <td></td> </tr> <tr> <td>MID (2 W)</td> <td>LOW</td> <td></td> </tr> <tr> <td>LOW (0.5 W)</td> <td>LOW</td> <td></td> </tr> </tbody> </table>	Tx Power	Icon	TX Power Meter during transmission	HIGH (5 W)	(No display)		MID (2 W)	LOW		LOW (0.5 W)	LOW		18
Tx Power	Icon	TX Power Meter during transmission												
HIGH (5 W)	(No display)													
MID (2 W)	LOW													
LOW (0.5 W)	LOW													
DW	Appears when the Dual Receive(DW) function is enabled.	29												
	Appears when the APO (Automatic Power-Off) function is enabled.	35												
	Appears when the bell function in the analog FM mode is enabled.	36												
	Appears when the lock function is enabled.	18												
DN	V/D mode (Normal digital mode)	17												
VW	Voice FR mode (Voice wide mode)	17												
FM	Analog FM mode	17												
AM	AM mode (Receive only)	17												
	DTMF Autodialer Active	-												

Safety Precautions (Be Sure to Read)

Be sure to read these important precautions, and use this product safely.

Yaesu is not liable for any failures or problems caused by the use or misuse of this product by the purchaser or any third party. Also, Yaesu is not liable for damages caused through the use of this product by the purchaser or any third party, except in cases where ordered to pay damages under the laws.

Types and meanings of the marks



DANGER

This mark indicates an imminently hazardous situation, which, if not avoided, could result in death or serious injury.



WARNING

This mark indicates a potentially hazardous situation, which, if not avoided, could result in death or serious injury.



CAUTION

This mark indicates a potentially hazardous situation, which, if not avoided, may result in minor or moderate injury or only property damage.

Types and meanings of symbols



These symbols signify prohibited actions, which must not be done to use this product safely. For example:  indicates that the product should not be disassembled.



These symbols signify required actions, which must be done to use this product safely. For example:  indicates that the power plug should be disconnected.



DANGER



Do not use this product in an area where RF transmitters are prohibited, e.g., inside of a hospital, airplane, or train.

This product can affect electronic or medical devices.



Do not transmit with this device while carrying or using a medical appliance such as a cardiac pacemaker. When transmitting, use an external antenna and keep as far as possible away from the external antenna.

The radio wave emitted by the transmitter can cause the medical device to malfunction and result in injury or death.



Do not transmit with this device in a crowded place for the safety of persons using a medical device such as a cardiac pacemaker.

The radio wave emitted from this product can cause the medical device to malfunction and result in injury or death.



If thunder and lightening develop nearby when an external antenna is used, immediately turn this transceiver OFF, and disconnect the external antenna from it.

A fire, electrical shock, or damage may result.



Do not use this product or the battery charger anywhere inflammable gas is produced.

A fire or explosion can occur.



Do not use this product while riding a bicycle or driving a car. Accidents can result.

Be sure to stop the bicycle or car at a safe place before using this product.



Do not touch any material leaking from the LCD display or the battery pack with bare hands.

The chemical may adhere to your skin or enter your eye, and cause chemical burns. In such a case, consult the doctor immediately.



Do not solder or short-circuit the terminals of the battery pack.

A fire, leak, overheating, explosion, or ignition may result.

Do not carry the battery pack together with a necklace, hairpin, or small metal objects. A short circuit can result.



WARNING



Do not disassemble or make any alteration to this product.

An injury, electric shock, or failure may result.



Do not handle the battery pack or charger with wet hands. Do not insert or remove the power plug with wet hands.

An injury, leak, fire, or failure may result.



Keep the terminals of the battery pack clean.

If terminal contacts are dirty or corroded, a fire, leak, overheating, explosion, or ignition can result.

- 

If smoke or a strange odor is emitted from the main body, battery pack, or battery charger, immediately turn the transceiver off; remove the battery pack, and remove the power plug from the outlet.
A fire, chemical leak, overheating, component damage, ignition, or failure may result. Contact the dealer from which you purchased this product or Yaesu Amateur Customer Support.

- 

Do not bend, twist, pull, heat and modify the power cord and connection cables in an unreasonable manner.
This may cut or damage the cables and result in fire, electric shock and equipment failure.

- 

Do not pull the cable when plugging and unplugging the power cord and connection cables.
Always hold the plug or connector when unplugging; if not, a fire, electric shock and equipment failure may result.

- 

Do not use the device when the power cord and connection cables are damaged, or when the DC power connector cannot be plugged in tightly.
Contact Yaesu Amateur Customer Support or the retail store where this transceiver was purchased for assistance, as this may result in fire, electric shock and equipment failure.

- 

Never cut the fuse holder off of the DC power cord.
This may cause a short circuit and result in ignition and fire.

- 

Use only the specified type fuses.
Use of an incorrect fuse may result in fire and equipment failure.

- 

Do not install the front panel, the transceiver or the wire cables near the automobile air bags.
In case of an accident, the transceiver may interfere with air bag deployment and result in extreme injury. The wire cables may also cause the air bag to malfunction.

- 

Do not power this transceiver with a voltage other than the specified power supply voltage.
A fire, electric shock, or damage may result.

- 

Do not make very long transmissions.
The main body of the transceiver may overheat, resulting component failure or operator burns.

- 

Do not place the transceiver in wet or damp areas (e.g. near a humidifier).
This may result in fire, electric shock and equipment failure.

- 

Do not use DC power cords other than the one enclosed or specified.
This may result in fire, electric shock and equipment malfunctions.

- 

When connecting a DC power cord, be certain the positive and negative polarities are correct.
Reverse connection will result in equipment damage.

- 

When transmitting, keep the transceiver at least 5.0 mm (3/16 inch) away from your body. Use only the supplied antenna. Do not use modified or damaged antennas.

- 

Disconnect the power cord and connection cables before installing separately sold accessory items, or replacing the fuse.
This may result in fire, electric shock and equipment failure.

- 

Follow the instructions provided when installing items sold separately and replacing the fuse.
This may result in fire, electric shock and equipment failure.

- 

Use only the provided or specified screws.
Using screws of a different size, may result in fire, electric shock and component damage.

- 

Do not place the transceiver in a confined space, such as a bookshelf which is not ventilated well.
This may result in overheating and fire, electric shock and equipment failure.

- 

Do not operate the transceiver on a carpet or a blanket.
This may result in overheating and fire, electric shock and equipment failure.

- 

If a foreign substance is spilled into the transceiver, turn it OFF immediately and remove the power plug from the outlet.
If used as it is, a fire, electrical shock, or damage may result.

CAUTION

- 

Do not place the transceiver on an unsteady or sloping surface, or in a location with extreme vibration.
The transceiver may fall or drop, resulting in fire, injury and equipment damage.

- 

Do not place this transceiver in a humid or dusty place.
A fire or failure may result.

- 

Do not use the transceiver near the radio relay equipment.
Transmissions may affect radio communication.

- 















Do not wipe the case using thinner and benzene etc.
Use only a soft, dry cloth to wipe stains from the case.

- 

Do not throw the transceiver, or subject it to strong impact forces.
Physical abuse may result in component damage and equipment failure.

- 

If the transceiver will not be used for an extended period, turn it OFF and remove the battery pack for safety.

-  **Keep magnetic cards and videotapes away from the transceiver.**
The data recorded on cash cards or videotapes may be erased.
-  **Do not place this transceiver in direct sunlight or near a heater.**
The case may be deformed or discolored.
-  **Be sure to check with the manufacturer of any hybrid or fuel-saving automobile regarding use of the transceiver in that car.**
Noise generated by an onboard electrical device (inverter, etc.) can disrupt the normal operation of the transceiver.
-  **Do not operate the transceiver near the TV or radio.**
Radio disturbance can occur in the transceiver, the TV, or the radio.
-  **Do not transmit near the television and radio.**
Transmissions may cause electromagnetic interference.
-  **While transmitting, keep the antenna as far from you as possible.**
Long-time exposure to electromagnetic waves may have a negative impact on your health.
-  **Do not dangle or throw the transceiver by holding its antenna.**
This may injure others and may also result in damage and failure of the transceiver.
-  **Do not use the transceiver in a crowded place.**
The antenna may strike others and result in an injury.
-  **Keep this product out of the reach of children.**
Injury to the child, or damage to the transceiver may result.
-  **Do not use any products other than the specified options and accessories.**
Failure or miss operation may result.
-  **Install the hand strap and belt clip securely.**
Improper installation may cause the FT-70DR/FT-70DE to fall or drop, resulting in an injury or damage.
-  **This product has a waterproof structure and conforms to "IP54" when the included antenna and battery pack are installed and rubber caps are securely attached to the MIC/SP jack, EXT DC IN jack, and DATA terminal. If this transceiver gets wet, dry it with a soft cloth, do not leave it exposed to the moisture.**
Exposure to excessive moisture may degrade the transceiver performance, shorten its life, or cause a failure or electrical shock.
-  **Before discarding a depleted battery pack, affix tape or insulating covering to its terminals.**
-  **Do not use at extremely low atmospheric pressure.**





About Splash, Water, and Dust Resistant Features Conforming to IP54

When the included antenna and battery pack are installed, and the MIC/SP jack, EXT DC IN jack and DATA terminal are securely covered with rubber caps, this product is dust and splash resistant. To ensure continued Splash, Water, and Dust Resistant Features be sure to check the following points before each use.

- Check for damages, deterioration, and dirt.**
Antenna rubber, key switch rubber, MIC/SP jack, EXT DC IN jack, DATA terminal rubber cap, and battery pack seals.
- Cleaning**
Wipe with a dry soft cloth.
When this product is contaminated with seawater, sand or dirt, clean it with a soft damp cloth immediately.
- Recommended maintenance interval**
To insure continued optimal performance, it is recommended that maintenance be performed annually, or when any damage or deterioration is found.
Note that the maintenance service is subject to fees.
- Do not pour or immerse this product in the following liquids:**
Sea, pool, hot spring, water containing soap, detergent, or bath additive, alcohol, or chemicals.
- Do not leave this product for an extended time in a very humid location:**
Bathroom, kitchen, or humid place.
- Other precautions**
Do not remove the rubber cap from the battery pack, the MIC/SP jack, the EXT DC IN jack, or the DATA terminal when water drops have accumulated on the transceiver, or when it is placed in a wet environment. This may result in water penetrating the transceiver, and causing equipment failure.
This product is not totally waterproof, and must never be immersed in water.

About this manual

Reference icon symbols and conventions are used in this manual. Their meanings are described in the below chart.

Symbols	Description
	This icon indicates cautions and information that should be read.
	This icon indicates notes, tips and information that should be read.
	This icon indicates other pages containing relevant information.
	This icon indicates FT-70DR/DE Advance Manual on the YAESU Website containing relevant information.

- The settings at the time of purchase are referred to as the “default” or “default settings”.
- The names of Set Mode items displayed in the LCD, and the key names of the transceiver appear in bold characters.

Supplied Accessories and Options

Supplied Accessories

- | | |
|---|---|
| <input type="checkbox"/> 7.4 V, 1800 mAh Rechargeable Li-Ion Battery Pack | SBR-24LI |
| <input type="checkbox"/> Battery Charger | SAD-18B*1
SAD-11C/F/U*2 |
| <input type="checkbox"/> Antenna | <input type="checkbox"/> Operating Manual (this manual) |
| <input type="checkbox"/> Belt Clip | <input type="checkbox"/> Warranty Card |
| <input type="checkbox"/> USB cable | <input type="checkbox"/> SBR-24LI Manual |



- Ensure that the name of the dealer from which the transceiver was purchased, and the date of purchase are indicated on the warranty card.
- If any item is missing, contact the dealer from which the transceiver was purchased.

Available Options

- | | |
|---|---|
| <input type="checkbox"/> 7.4 V, 1800 mAh Rechargeable Li-Ion Battery Pack | SBR-24LI |
| <input type="checkbox"/> Battery Charger | SAD-18B*1
SAD-11C/F/U*2 |
| <input type="checkbox"/> Rapid Charger | SBH-28 |
| <input type="checkbox"/> DC Cable with and Cigarette-Lighter Plug | SDD-13 |
| <input type="checkbox"/> DC Cable | E-DC-6 |
| <input type="checkbox"/> Speaker / Microphone | MH-34B4B |
| <input type="checkbox"/> VOX Headset | SSM-63A |
| <input type="checkbox"/> BNC-to-SMA Adapter (BNCJ-SMAP) | CN-3 |
| <input type="checkbox"/> Cloning Cable | CT-27 |
| | <input type="checkbox"/> Earpiece Microphone SSM-57A |
| | <input type="checkbox"/> Microphone Adapter CT-44 |
| | <input type="checkbox"/> Soft Case SHC-27 |

*1 USA Version

*2 “B” suffix is for use with 120 VAC (Type-A plug), “C” suffix is for use with 230-240 VAC (Type-C plug), “F” suffix is for use with 220 VAC, “H” suffix is for use with 220-230 VAC (Australian plug), and “U” suffix is for use with 230 VAC (Type-BF plug).

Availability of accessories may vary. Some accessories are supplied as standard to meet local requirements, while others may be unavailable in some regions. Consult your Yaesu Dealer for details regarding these and any newly-available options. Connection of any accessory not approved by Yaesu, should it cause damage, may void the Limited Warranty on this apparatus.

Preparation

Installing the Antenna

1. Turn the antenna clockwise until it is secured.



- Do not hold or twist the upper part of the antenna when installing or removing it. To do so may break the conductors inside the antenna.
- Do not key the transmit without installing the antenna. The transmitter components may be damaged.
- When using an antenna other than the one supplied, or connecting to an external antenna, ensure that the SWR is adjusted to 1.5 or lower.

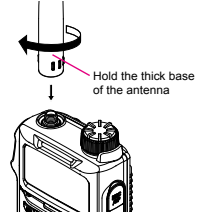

Attaching the Belt Clip

1. Attach the belt clip on the back of transceiver using the supplied screws (two).



- Be sure to use the supplied screws when attaching the belt clip. If any other screws are used, the belt clip cannot be secured firmly to the battery pack and the transceiver may drop off together with the battery pack; the transceiver and battery pack may fall off, causing injury, breakage and other damage.
- Use a hand strap which can withstand the weight of the transceiver. If the hand strap is not strong enough, the it may break and the transceiver may fall, causing injury, breakage and other difficulty.

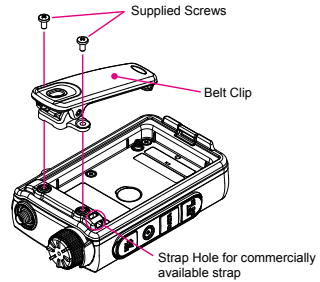

Installing the Battery Pack

1. Lift the belt clip outward (①) and Insert the battery pack into the seals of the battery compartment on the back of the transceiver.
2. Push the battery pack in until the battery latch clicks securely (②).
3. Slide the battery pack lock plate to the "UNLOCK" position beside the battery latch until the entire "LOCK" appears.

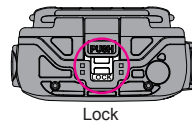
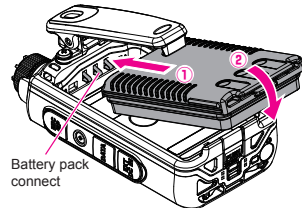

Caution

Risk of explosion if battery is replaced by an incorrect typ. Dispose of used batteries according to the instructions.

Removing the Battery Pack

1. Slide the battery pack lock plate to the "UNLOCK" position.
2. Push the release button (PUSH) and tilt the Belt Clip outward, and then remove the battery pack.



Charging the Battery Pack

Charging the Battery Pack using the Battery Charger

Using the supplied battery charger (SAD-18B or SAD-11), it takes about 6 hours* to charge the SBR-24LI battery pack fully.

*: Depending on the battery status, the charging time might be increased.

1. Turn the transceiver **OFF** to install the battery pack.
2. Referring to the figure at the right, connect the battery charger plugs.

When the battery is being charged, the left side of the MODE/STATUS Indicator lights red, and "CHGING" is displayed.

3. When charging is completed, the display will change to indicate "CHGFUL" and the MODE/STATUS Indicator will light green.

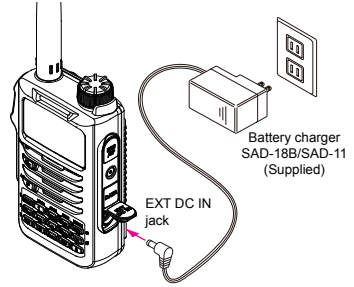

- In the USA Version, the MODE/STATUS Indicator is not lit when charging or when charging is complete.
- The charging icon blinks, and charge progress is shown on the S/PO bar graph "■■■■■■■■■■" meter during charging.





- When charging is completed, the charging is automatically ended.
- If "CHGERR" appears on the LCD during the charging and the battery pack is not charged after a lapse of 10 or more hours, stop charging the battery pack immediately. The battery pack is presumed to be at the end of its service life, or defective. In this case, replace the battery pack with a new one.
- Charge the battery pack within the temperature range from +5 °C to +35 °C (+41 °F to +95 °F).

Charging the Battery Pack using the Rapid Charger (SBH-28)

For details on the Rapid Charger (SBH-28), see Optional SBH-28 manual.

• Approximate Operating Time and Remaining Charge Level Indication

Approximate operating time for the transceiver with the fully charged lithium-ion battery pack (SBR-24LI), and the indication of the remaining charge level of the battery is shown in the below table:

Frequency band	Band in Use Charge	Level Indication (Icon)
144 MHz band	Approx. 8 hours	(No display) :Full battery power  :Enough battery power
430 MHz band	Approx. 7 hours	 :Battery is depleted. Charge battery.  : (When blinking) Charge battery immediately.

The battery charge level calculations are based on an operating cycle of: Transmitting 6 seconds (5 W): Receiving 6 seconds (VOL Level 16): Stand By 48 seconds (RX SAVE 1:5)

The actual times the transceiver will operate as indicated in the above table, varies depending on use, conditions, ambient temperature, etc.

External Power Supply

Connecting an External Power Supply for Use in Vehicle

The optional DC Cable with Cigarette-Lighter plug (SDD-13) allows power to be supplied from a motor vehicle type cigarette lighter socket.

Connecting to an External Power Supply Using a Power Cable

The optional DC cable (E-DC-6) allows the transceiver to be connected to an external DC power supply.

Operation

Turning the Transceiver ON

1. Press and hold the **Power (Lock)** switch to turn the transceiver **ON**.

• Turning the transceiver OFF

Press and hold the **Power (Lock)** switch again to turn the transceiver **OFF**.

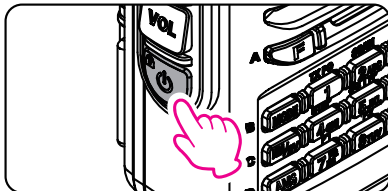

• Inputting the call sign

The first time the transceiver is turned ON after it is purchased; input your own call sign.

• Inputting characters

Input the callsign with the ten key or **DIAL** knob.

• Rotate the **DIAL** knob to select any of the 38 available characters:.

... ⇨ 0-9 ⇨ **A-Z** ⇨ (space) ⇨ - ⇨ / ⇨ ...

* The "-" and "/" may not be input for the first callsign character.

• Press the keys repeatedly to toggle among the four available characters associated with that key. For example: pressing the [2] repeatedly will toggle through **A** → **B** → **C** → **2** → **A** ...

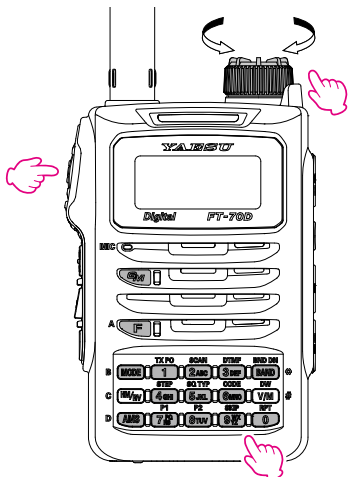

• Moving the cursor and deleting the input characters:

[BAND] key: Moves the cursor to the right

[MODE] key: Moves the cursor to the left

[GM] key: Press and hold to erase all characters after the cursor

• Saving the inputted call sign:

Press the **[F]** key or the **PTT** switch

- The Call Sign ID can be changed using set mode item [64* (63) MYCALL] (□ 37). (*: USA Version)



Up to 10 characters can be entered.

- Characters that may be inputted for the call sign are the numbers 0-9, letters "A-Z" in upper case, the hyphen and the slash.

Adjusting the Volume Level

1. While pressing and holding the **VOL** knob, rotate the **DIAL** knob to adjust the volume to a comfortable level.

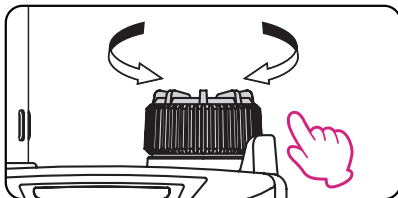
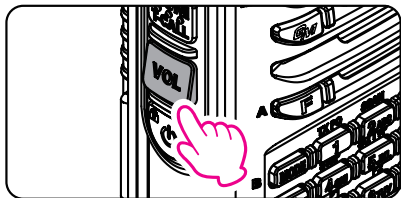

Adjusting the squelch setting

The squelch level may be adjusted to mute the background noise when no signal is present.

1. Press the **[F]** key and then press the **MONI/T-CALL** switch.

“SQL □” (0 - 15) appear on the display.

2. Rotate the **DIAL** knob to adjust to a level at which the background noise is muted.

3. Press the **PTT** switch to save the setting.



- The default setting is “SQL 1”
- When the squelch level is increased, the noise is more likely to be silenced, but it may become more difficult to receive weak signals.

Selecting a Frequency Band

1. Press the **[BAND]** key to select the desired frequency band.

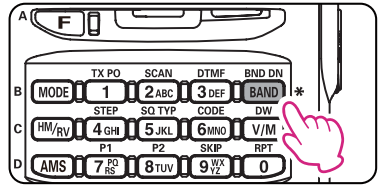

Frequency ranges for each frequency band are below:

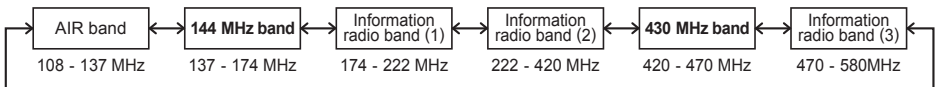

Press the **[F]** key, then press the **[BAND]** key to switch the frequency bands in reverse order.

Tuning to a Frequency

• **DIAL** knob

By pressing the **[F]** key and then rotating the **DIAL** knob, the frequency will change in 1 MHz steps.

• The numeric keys

Press the numeric keys to enter the frequency digits in order, beginning with the 100 MHz digit.



When entering a frequency using the numeric keys, it may be canceled by pressing the **PTT** switch.

Changing the Frequency Step

The **DIAL** knob rotation frequency step may be changed. Normally, the factory default setting will provide a good frequency step.

1. Press the **[F]** key and then press the **[4]** (STEP) key, and rotate the **DIAL** knob to change the frequency step.

2. Press the **PTT** switch to save the setting and return to normal operation.



In the default setting, of the frequency step is set to “**AUTO**”, which automatically provides a suitable frequency step according to the frequency band.

Selecting the Communication Mode

Using AMS (Automatic Mode Select) function

The **FT-70DR/DE** transceiver is equipped with the AMS (Automatic Mode Select) function which automatically selects the communication mode corresponding to the received signal.

1. Press and hold the **[AMS]** key to turn the AMS function **ON** or **OFF**.

When the AMS function is turned OFF, the communication mode must be selected manually. See "(Fixing the Communication Mode)".

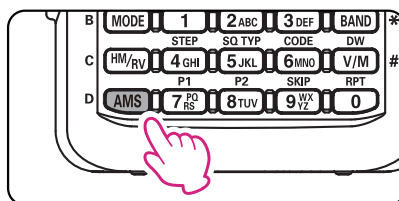

The selected communication mode is displayed under the AMS icon.

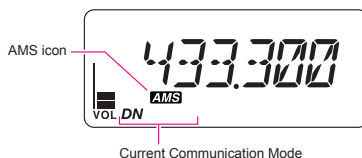

- The default setting is "ON" in the AMS function.
- AMS function may only be turned ON when operating within the 144 MHz and 430 MHz Amateur Bands

● Setting the transmission mode when using the AMS function

The AMS function will automatically set the receiver to the mode of the received signal, but the transmission mode may be fixed regardless of the received mode.

1. Press the **[AMS]** key.
2. Rotate the **DIAL** knob to tune to the desired transmission mode as follows.

Transmit Mode	Receive and Transmit
TX AUT (TX AUTO)	Receive: Automatically selects the communication mode of transmission according to the signal being received. Transmit: Transmits automatically in the communication mode selected by the AMS function, or in the mode selected manually by pressing the [MODE] key.
TX FM	Receive: Automatically selects the communication mode of transmission according to the signal being received. Transmit: Always transmits in the analog FM mode.
TX DIG (TX DIGITAL)	Receive: Automatically selects the communication mode of transmission according to the signal being received. Transmit: Always transmits in the DN mode.

3. Press the **[AMS]** key or the **PTT** switch to save the setting and return to normal operation.



When the AMS function is **ON**, press the **[MODE]** key to change the communication mode temporarily.

Fixing the Communication Mode

1. To fix the transmit operation mode, press and hold the **[AMS]** key to turn the AMS function **OFF**. The “AMS” icon turns off.
2. Press the **[MODE]** key to change the communication mode.



Communication Mode	Icon	Description of Modes
V/D Mode (Voice/Data simultaneous transmission mode)	DN	This is the standard digital mode. Calls are less prone to interruptions caused by detection and correction of the received digital voice signal.
Voice FR Mode ^{*1} (Voice Full Rate Mode)	VW ^{*1}	High speed data communication using entire 12.5 kHz band. Enables high-quality voice communication.
FM Mode	FM	Analog communication using FM mode.
AM Mode (receive only) ^{*2}	AM	The AM mode for receive only.

*1 When the Set Mode [16 DIG VW] (□□ 36) is set to “ON” (factory default is “OFF”), the Voice FR mode (VW) may be selected.

*2 When the Set Mode [47 RX MOD] (□□ 37) is set to “AUTO” (factory default setting), AM mode is automatically selected within the AIR band (108 - 136.995 MHz).

Transmission

1. While pressing and holding the **PTT** switch, speak into the microphone.
The **MODE/STATUS** Indicator lights during the transmission.

Transmission mode	Left portion	Right portion
Analog FM	Red	Red
Digital C4FM mode		Blue



If the **PTT** switch is pressed when a frequency other than the amateur ham radio band is selected, an alarm tone (beep) will be emitted and “**ERROR**” appears on the LCD, disabling transmission.

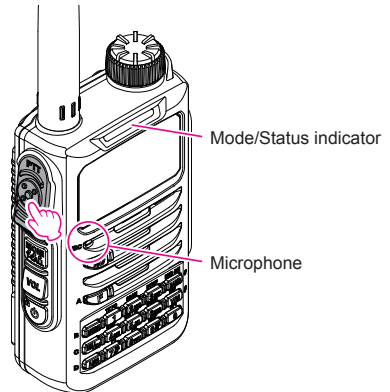

2. Release the **PTT** switch to return to receive mode.
When receiving a signal, the **MODE/STATUS** Indicator lights according to the receive mode.

Receive mode	Left portion	Right portion
Analog FM	Green	Green
Digital C4FM mode		Blue



If transmission is continued for a long period, the transceiver overheats and the high temperature protection function is activated. As a result, the transmitting power level is automatically set to Low Power. If transmission continues while the high temperature protection function is active, the transceiver will be forcibly returned to the receive mode.

Changing the Transmission Power Level

1. Press the **[F]** key, then press the **[1](TX PO)** key.
2. Rotate the **DIAL** knob to select one of the following transmission power levels.

TX PO Level	Icon	PO meter
HIGH (5 W)*	(off)	
MID (2 W)	LOW	
LOW (0.5 W)	LOW	

*The default setting.

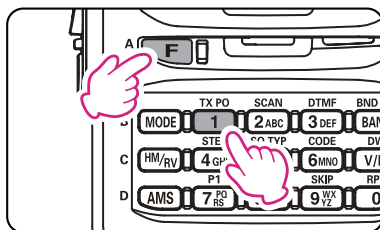

3. Press the **PTT** switch to save the setting and return to the normal operation.



The transmission power level may be set separately for each frequency band.

Locking Keys and DIAL knob

1. Press the **[POWER] (LOCK)** switch, “**LOCK**” is displayed on the LCD for one second, the “” icon appears on the LCD, and then the keys and **DIAL** knob are locked.

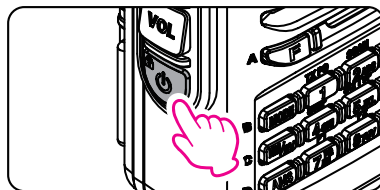

- The keys, the **DIAL** knob, and the **PTT** switch may be selected to be locked using Set Mode **[30 LOCK]** (□□ 36).
The default setting is the **[K+D]** (the keys and the DIAL knob are locked).
- The **[MONI/T-CALL]** switch and the **VOL** switch cannot be locked.

2. Press the **[POWER] (LOCK)** switch again, “**UNLOCK**” will be displayed on the LCD and keys and the **DIAL** knob are unlocked.

Programmable key function

The **[7] (P1)** and or the **[8] (P2)** keys are user programmable, allowing quick access to the Set Modes that are used most often.

• Assigning Set Mode Items to the Programmable Keys

1. Press and hold the **[F]** key, and then rotate the **DIAL** knob to select the desired Set Mode item.
2. Press and hold the **[7](P1)** key or the **[8](P2)** key.
“**P1KEY**” or “**P2KEY**” appears on the LCD and return to the Set Mode.
3. Press the **PTT** switch to return to the normal operation.

• Recalling the assigned Set Mode item

1. Press the **[F]** key and then press the **[7](P1)** key or **[8](P2)** key.
The assigned Set Mode item appears on the LCD.



The **[7] (P1)** is **[12 DC VLT]** (□□ 36) and **[8] (P2)** key is **[47 RX MOD]** (□□ 37) as a default assignment.

Using the convenient Digital C4FM feature

About the Digital Group ID (DG-ID) feature

1. Digital Group ID (DG-ID) function allows communications with only the specific group members using the two-digit ID numbers. The desired DG-ID number from 00 to 99 is set in advance by all the group members. This ID number may be set separately for transmit and receive, when the same ID number is set for both transmit and receive, only group members with the same ID number will be heard. This feature may be used to communicate only with group members that have the same DG-ID number. The GM function may also be utilized to automatically monitor whether or not group member stations with the same DG-ID number are operating within communication range.

The DG-ID number 00 detects signals with all ID numbers. Normally setting the ID number to “00” for both transmit and receive will permit reception of the signals from all other stations using the digital C4FM mode, regardless of the transmit DG-ID number settings of the other stations.

Also note that when the receive DG-ID number of your transceiver is set to a DG-ID number other than “00”, received signals that do not have the same DG-ID number may not be heard.

2. When accessing the C4FM digital repeater controlled by the DG-ID number, set the transmit DG-ID number of the FT-70DR/DE to that of the repeater input. Even in that case, if the receive DG-ID number of the FT-70DR/DE is set to “00”, all the downlink signals from the repeater may be received.

Communicating with the DG-ID feature



- Digital C4FM mode transceivers compatible with the DG-ID function are required in order to utilize this function.
- If the firmware is not compatible with the DG-ID function, update the latest firmware to use the DG-ID function. The latest firmware is available on the YAESU website.

Setting the transmit and receive DG-ID number to “00” for communicating with all other stations using C4FM digital mode

1. Press and hold the **[MODE]** key.
 - The DG-ID number setting screen appears and the transmit DG-ID number “T00” blinks.
 - If the transmit DG-ID number is not set to “T00”, rotate the **DIAL** knob to set “T00”.



2. Press to the **[MODE]** key again and the receive DG-ID number “R00” will blink.
If the receive DG-ID number is not set “R00”, rotate the **DIAL** knob to set “R00”.



3. Press and hold the **[MODE]** key, or press the **PTT** switch to save the setting and return to the normal operation.
The setting is complete.

4. To check whether or not other stations are operating within communications range, press the **[GM]** key to turn the GM (Group Monitor) function ON.
 - The other stations also need to turn the GM (Group Monitor) function ON.
 - While operating with the GM (Group Monitor) function, “Operating Frequency”, “GROUP” and “DG-ID number” are shown repeatedly on the LCD.
5. Press the **[GM]** key to turn the GM (Group Monitor) function OFF and return to the normal operation.
 - While setting the DG-ID number, pressing and holding the **[HM/RV]** key will set the transmit and the receive DG-ID numbers to “00”.
 - If the receive DG-ID is set to a number other than “00”, only signals with that DG-ID will be received. Normally, set the receive DG-ID number to “00” except when communication is desired only with group members.
 - The transmit and receive DG-ID default number is set to “00”.



Communicating only with the specific members by setting the DG-ID number except for “00”

Example Set the DG-ID number of to “50”

1. Press and hold the **[MODE]** key.
 - The DG-ID number setting screen appears and the transmit DG-ID number “T00” blinks.
 - Rotate the **DIAL** knob to set the transmit DG-ID number to “T50”.



2. Press to the **[MODE]** key again to blink the receive DG-ID number “R00”.
Rotate the **DIAL** knob to set the reception DG-ID number to “R50”.



3. Press and hold the **[MODE]** key or press the **PTT** switch to save the setting and return to normal operation.
Tuning to the same frequency and setting the same DG-ID for all the group members will enable communication between the members and exclude other signals.
4. Press the **[GM]** key to turn the GM (Group Monitor) function ON and check whether or not other stations that are operating on frequency, with the GM (Group Monitor) function ON, and have the same GD-ID number setting, are in the communication range.
 - The other stations also need to turn the GM (Group Monitor) function **ON**.
 - During operating on the GM (Group Monitor) function, “Operating Frequency”, “GROUP” and “DG-ID number” are shown repeatedly on the LCD.
5. Press the **[GM]** key to turn the GM (Group Monitor) function OFF and return to the normal operation.



- While setting the DG-ID number, pressing and holding the **[HM/RV]** key will set the transmit and the receive DG-ID numbers to “00”.
- If the receive DG-ID is set to a number other than “00”, only signals with that DG-ID will be received. Normally, set the receive DG-ID number to “00” except when communication is desired only with group members.



For example, if the transmit and receive DG-ID numbers of group members are all set to "50", communications from other DG-ID numbers is not received and only the group members setting the same DG-ID numbers may communicate. Also, the other stations set the receive DG-ID to any number except for "00" may not be received the signals of your stations.

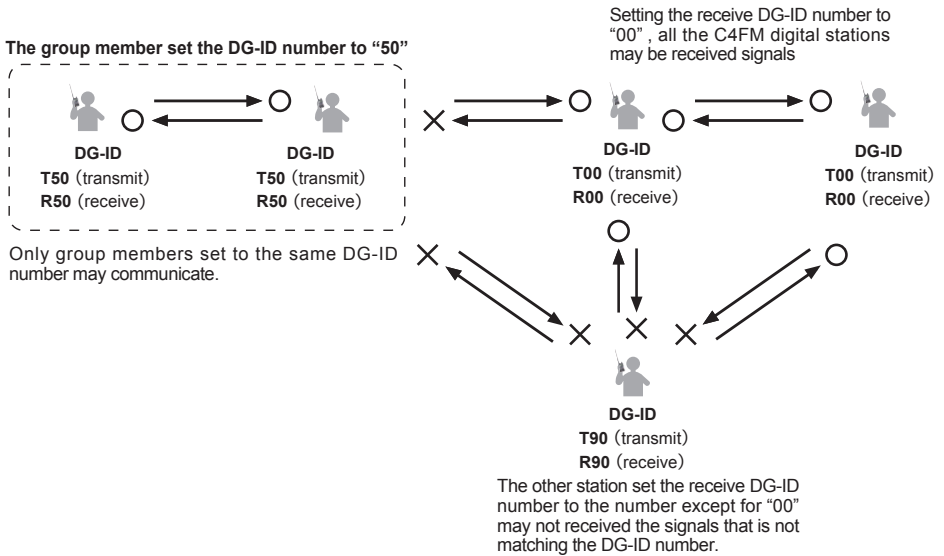

About the GM(Group Monitor) feature

The GM (Group Monitor) function automatically checks to find if there are any stations with the GM function in operation with the same DG-ID number within communication range. Setting the receive DG-ID number to "00" will check for all the C4FM digital stations In/Out of range.



- Activating the GM (Group Monitor) function, the Digital C4FM mode is changed. For communicating in the Analog FM mode, Set the GM function OFF.
- The other member stations must also turn the GM (Group Monitor) function ON.

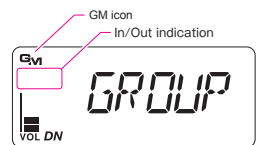

When the GM (Group Monitor) is activated, the following information screens are automatically switched.

GM information screen

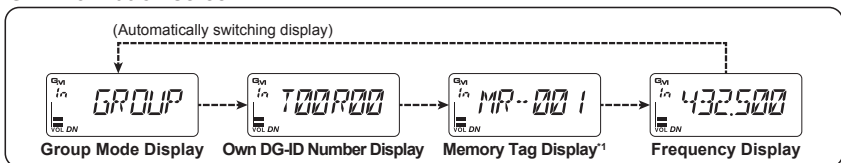

* 1 : Memory tag display is displayed in the case of the memory channel or the home channel setting the memory tag.

• In / Out Display

- When another station with the same DG-ID number is within the communication range, a beep sounds and the "In" is displayed under the GM (Group Monitor) function icon, and the right side of the **MODE/STATUS** indicator lights in light blue.
- When all the members are out of the communication range, "out" is displayed and the **MODE/STATUS** indicator light is off.
- When a signal from another member station is received, the call sign of the other station is displayed on the LCD for about 10 seconds.



When the DG-ID transmit and receive are set to "00" in the factory default setting, all stations In/Out of range may be received and are displayed, but the other stations that set their receive DG-ID number to other than "00" may not be receiving your signals.

Displaying the information of the other station received by GM (Group Monitor) function

1. When receiving the signals with the same DG-ID number, press the **[MODE]** key to reveal the other station information:
 - Depending on the model, the information such as the call sign of the other station, latitude, longitude and so on may be displayed.
 - When receiving the signals of multiple stations, press the **[MODE]** key to display the call sign of the other station, and then rotate the DIAL knob to select the other stations to be displayed on the LCD.
 - Up to 24 stations may be displayed in order of their reception.

- The FT-70DR/DE may not send its own location information because the FT-70DR/DE is not equipped with the GPS function.
- The position information is displayed only when the latitude and longitude information is included in the signal of the other station.
- The transceivers that may transmit position information with the GM function are as follows: (As of Nov. 2017).
FTM-400XD / FTM-400D series, FTM-100D series, FT2D, FT1XD, FT1D, FT-991A / FT-991*
(*: Latitude and longitude setting must be entered manually, or an external GPS device must be connected.).



GM information screen

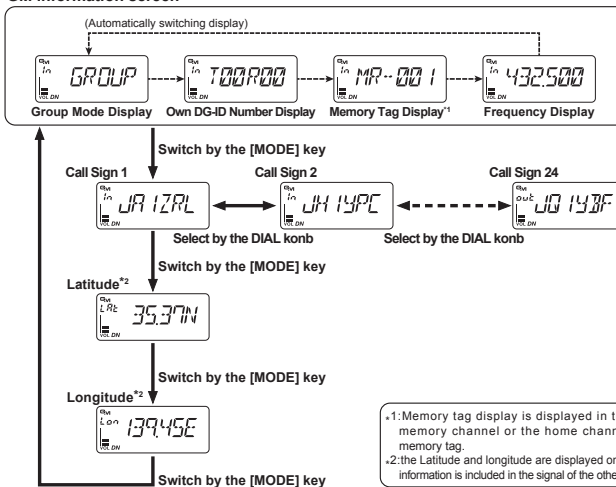

When the call sign or latitude/longitude is being displayed, the displayed station is given priority. So even when another station is received the display is not changed. While using the call sign display screen, rotate the **DIAL** knob to select another station display.

Communicating Via the Repeater

The transceiver includes an ARS (Automatic Repeater Shift) function which sets the repeater operation automatically when the receiver is tuned to the repeater frequency.

1. Set the downlink (output) frequency from the repeater.
2. “**■**”, “**+**” or “**T**” Icons may automatically appear above the frequency.
3. Speak into the microphone while pressing and holding the **PTT** switch.

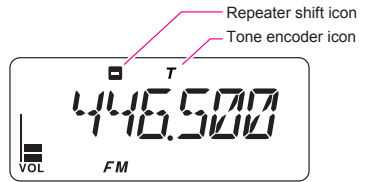

• The reverse state

The “reverse” state temporarily reverses the transmit and receive frequencies. This allows checking to find if direct communication with the other station is possible.

1. When the ARS in ON, press the **[HM/RV]** key.
 - The transmit and receive frequencies are temporarily reversed (“reverse” state).
 - In the “reverse” state, the “**■**” or “**+**” blinks on the LCD.
2. Press the **[HM/RV]** key to exit from the “reverse” state.

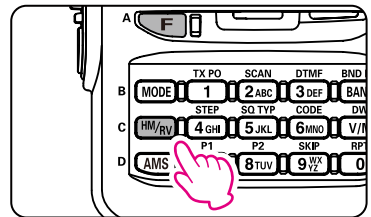

- The repeater settings may be changed from the Set Mode.



Set Mode **[46 RPT.FRQ]**: Allows changing the repeater shift offset.

[F] key → **[0]** (**RPT**) key: Allows setting the repeater shift direction.

[F] key → **[6]** (**CODE**) key: Allows setting the tone encoder frequency.

- The ARS function may be set to **OFF** in the Set Mode **[45 RPT.ARS]**.

The Yaesu DR-2X/XE repeater incorporates the DG-ID feature, which may limit access to the repeater by using a two-digit 01 to 99 ID number. Multiple DR-2X/XE repeaters, connected via the Internet may also be managed using the DG-ID numbers. To access a specified DR-2X/XE repeater, or DR-2X/XE repeater group, that requires a DG-ID, the FT-70DR/DE transmit DG-ID must be set/programmed accordingly. Also, when communicating via a DR-2X/XE repeater, set the receive DG-ID number to “00”.

Tone Calling (1750 Hz burst tone)

If your transceiver is FT-70DE (European version), press and hold in the **MONI/T-CALL** switch to generate the 1750 Hz burst tone to access the European repeater.

The transmitter will automatically be activated, and the 1750 Hz audio tone will be superimposed on the carrier. Once the repeater has been accessed, release the **MONI/T-CALL** switch, and use the **PTT** switch to activate the transmitter thereafter.

If needed, the FT-70DR (USA/Asian version), may be set to access repeaters which require a 1750 Hz burst tone by setting the **MONI/T-CALL** switch to serve as a “Tone Call” switch instead. To change the configuration of the **MONI/T-CALL** switch, use Set Mode **[32 M/T-CL]** (☐37).

Using the Memory

The **FT-70DR/DE** transceiver incorporates Large-capacity memory channels that can register the operating frequency, communication mode, and other operational information.

- 900 Memory Channels
- 90 Skip Search Memory Channels
- 6 Home Channels
- 50 pairs PMS Memory Channels

Each memory channel can store the following information.

- Operating frequency
- TX output power
- Tone information
- S-Meter squelch level
- Communication mode
- Memory tag
- DCS information
- Skip memory information
- Frequency steps
- Repeater information
- ATT information
- Specified memory channel information

Memory channels can be sorted and registered into memory banks according to the desired use. The transceiver allows using 24 different memory banks. A maximum of 100 memory channels can be registered in each memory bank. One memory channel can be registered to several memory banks. One memory channel in one memory bank can be recalled, and the memory channels in the several memory banks can be scanned.

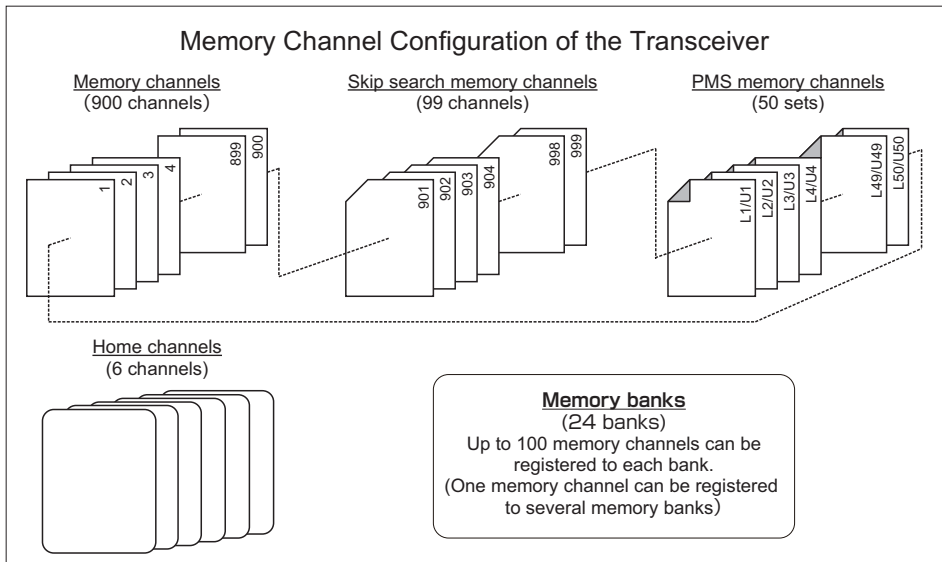

For additional details on the Skip Search Memory, PMS memory channel and Memory Bank, refer to the Advanced Manual which may be downloaded from the Yaesu website.

CAUTIONS!

The information registered to memory channels can be corrupted by incorrect operation, static electricity, or electrical noise. Also, it can be erased in the event of a failure or repair. Be sure to keep a record of the settings on paper.

Registering to Memory Channels

1. Set the frequency and the communication mode to be registered to a memory channel.

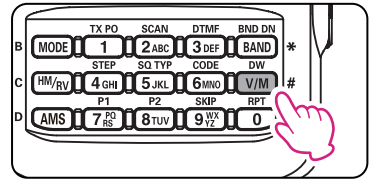

2. Press and hold the [V/M] key.

"F" blinks on the LCD.

3. Rotate the **DIAL** knob to select the desired channel number.

The channel numbers that do not contain memory data will blink on the LCD.

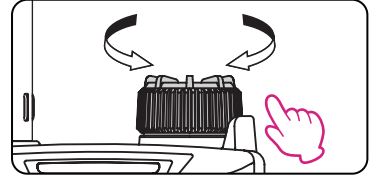

4. Press the [V/M] key.

- If you attempt to register a frequency to a memory channel that already contains frequency data, "M-WRT?" will appear on the LCD. Press the [V/M] key to overwrite the memory channel.
- The memory tag input screen will be displayed on the LCD.

5. Input the memory tag.

- Use the numeric keys or the **DIAL** knob to input the characters.

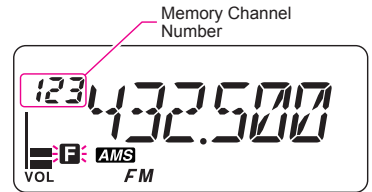

- **Example:** Rotating the **DIAL** knob to display the following characters.

⇨ A - Z ⇨ (symbol) ⇨ 0 - 9 ⇨ (symbol) ⇨ A - Z ⇨

- **Example:** Press the [2] key repeatedly to toggle among the following available characters.

A → B → C → 2 → A ...

- Moving the cursor and deleting the input characters

- [BAND] key: Moves the cursor to the right
- [MODE] key: Moves the cursor to the left
- [GM] key (press and hold): Erases all characters after the cursor

6. Press and hold the [V/M] key.

The beep sounds and the memory is saved.

Recalling a Memory Channel

1. Press the [V/M] key.

The memory channel most recently used appears on the LCD.

2. Rotate the **DIAL** knob to select the desired memory channel, or input the 3 digits of the memory channel using the numeric keys to recall the memory channel directly.

3. Press the [V/M] key to exit the memory mode, and return to the normal operation.

- The data registered to a memory channel can be transferred to the VFO operating band by following the procedure below:

Press and hold the [V/M] key → Rotate the **DIAL** knob to select the channel → Press and hold the [GM] key → "V-WRT?" appears → Press the [GM] key.



- Pressing the [F] key and then rotating the **DIAL** knob allows skipping memory channels quickly in steps of 10 memory channels.

- The transceiver may be placed into a Memory Channel Only mode, (which restricts the FT-70DR/DE to operate only on the memory channels), by pressing the [V/M] key, while pressing the **Power (Lock)** switch to turn the transceiver **ON**. To cancel the Memory Channel Only mode, turn the transceiver **OFF**, then press the [V/M] key again, while pressing **Power (Lock)** switch to turn the transceiver **ON**.

Clearing Memories

1. Press the **[V/M]** key to enter the memory mode.
2. Press and hold the **[V/M]** key.
3. Rotate the **DIAL** knob to select the memory channel from which the data is to be cleared.
4. Press the **[AMS]** key.
5. Confirmation screen “**M-MSK?**” is displayed and then press the **[AMS]** key again to clear the memory channel.



- Data on memory channel One, and the Home channel may not be cleared.
- The cleared memory can be restored using the following steps.

Press the **[V/M]** key to enter the memory mode → Press and hold the **[V/M]** key → Rotate the **DIAL** knob to restore the channel → Press the **[AMS]** key

Recalling the Home Channels

1. Press the **[F]** key, and then press the **[HM/RV]** key.
“**H**” and the home channel frequency of the currently selected band appears on the LCD.
2. Press the **[F]** key, and then press the **[HM/RV]** key or the **[V/M]** key to return to the previous frequency.

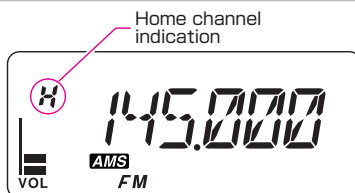

While recalling the home channel, rotate the **DIAL** knob to transfer the home channel frequency to the VFO operating band. The home channel frequency can be set not to be transferred in the Set Mode **[27 HM-VFO]** (□□36).

Changing the Home Channel Frequency

1. Set the frequency and the operating mode you want to store as a home channel.
2. Press and hold the **[HM/RV]** key.
The beep sounds and the home channel frequency is changed.



For additional details on the following functions, refer to the Advanced Manual which may be downloaded from the Yaesu website.

Split Memory

Two different frequencies, one for receive and another for transmit, can be registered to a memory channel.

Using Memory Tag

Memory name tags may be assigned to the memory channels and home channels.

Using Memory Bank

The transceiver allows using up to 24 memory banks to allow sorting and registering the channels in convenient groups.

The transceiver supports the following four scanning functions:

- VFO Scan
- Memory Channel Scan
- Programmable Memory Scan (PMS)
- Memory Bank Scan
- Weather Alert Scan (USA Version only)



For additional details on the Programmable Memory Scan (PMS) and Memory Bank Scan, refer to the Advanced Manual which may be downloaded from the Yaesu website.

VFO Scan

VFO scan function scans the frequencies, and detects signals.

1. Press the **[V/M]** key to enter the VFO mode.
2. Press the **[F]** key and then press the **[2](SCAN)** key.
 - Scanning starts toward higher frequencies.
 - If the **DIAL** knob is rotated while scanning is in progress, the scanning will continue up or down in frequency according to the direction of the **DIAL** Knob rotation.

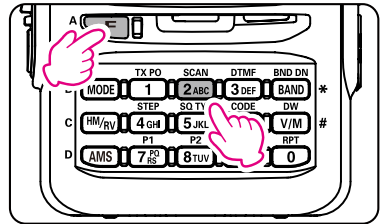

3. Press the **PTT** switch to cancel the scanning.
 - If the scan has paused on a signal, rotating the **DIAL** knob will cause scanning to resume instantly.
 - The manner in which the scanner resumes after it has paused on a signal may be selected within approx. 0.1 sec - 10 sec by using the Set Mode **[53 SCN.STR]** (□□37).



- When turning the transceiver **OFF** while scanning, turning the transceiver **ON**, will cause scanning to resume.
- To set the transceiver action when scanning stops, see "Setting the Receive Operation When Scanning Stops" on page (□□37).
- The following Set Modes allow scanning only the frequencies within the set band frequency range. The Set Mode **[49 SCM.WTH]** the frequency range on memory scanning (□□37). The Set Mode **[50 SCV.WTH]** the frequency range on VFO scanning (□□37).

Memory Channel Scanning

The receiver may be set to scan memory channels:

1. Recall a memory channel to begin memory scanning.
2. Press the **[F]** key and then press the **[2](SCAN)** key.
 - Scanning starts toward higher memory channel numbers.
 - If the **DIAL** knob is rotated while scanning is in progress, the scanning will continue up or down in frequency according to the direction of the **DIAL** Knob rotation.
 - If the scanner halts on an incoming signal, the back light will turn ON and the decimal point between the "MHz" and "kHz" digits of the frequency display will blink. Scanning will resume in about five seconds.
3. Press the **PTT** switch to cancel the scanning.



If the scan has paused on a signal, rotating the **DIAL** knob will cause scanning to resume next memory channel.

Setting the Receive Operation When Scanning Stops

1. Press and hold the **[F]** key to enter the Set Mode.
2. Rotate the **DIAL** knob to select the Set Mode [**52 SCN.RSM**].
3. Press the **[F]** key.
4. Rotate the **DIAL** knob to select the operation performed after the scan stops:
 - **2.0 S - 10.0 S**
The signal is received for a specified period of time, and then scanning resumes. The scan resume time may be set from 2 to 10 seconds at 0.5 second intervals.
 - **BUSY**
The signal is received until the signal fades out. Two seconds after the signal fades out, scanning resumes.
 - **HOLD**
Scanning stops and tuning remains on the current receive frequency (Scanning does not resume).
5. Press the **PTT** switch to save the new setting and exit to normal operation.



- The above setting (Set Mode [**52 SCN.RSM**] (□□37)) is common for all scanning operation.
- The time interval to resuming scanning after a received signal ends during scanning may be set between approx. 0.1 SEC to 10 SEC (the factory default is set to 2.0 SEC.) in the Set Mode [**53 SCN.STR**] (□□37).

Weather Alert Scan (USA Version only)

This feature allows you to check the Weather Broadcast Memory Channels for the presence of the NOAA Alert Tone while operating using VFO scan or Memory channel scan. When the Weather Alert Scan feature is engaged, the **FT-70DR/DE** will check the Weather Broadcast Channels for activity every five seconds while scanning. If you watch the display carefully, you'll observe the scanner periodically shifting to the Weather Broadcast channel, scanning the Weather channels quickly in search of the Alert Tone, after which regular scanning will resume for another five seconds.

1. Press and hold the **[F]** key to enter the Set Mode.
2. Rotate the **DIAL** knob to select the Set Mode [**61 WX ALT**] (□□37).
3. Press the **[F]** key and then rotate the **DIAL** knob to select "ON".
4. Press the **PTT** switch to save the setting and return to normal operation.
5. Press the **[F]** key and then press the **[2](SCAN)** key to start scanning.
 - Scanning starts searching upwards in frequency.
 - The display will remain on the VFO frequency, but every five seconds the transceiver will scan the Weather Broadcast Channels for activity.



6. While scanning the Weather channels, press the **PTT** switch and then press the **PTT** switch again.
 - Scanning starts within the Weather Broadcast Channels.
 - While scanning the Weather channels, press the **PTT** switch and then rotate the **DIAL** knob to select the desired Weather Broadcast Channel.
7. Press the **[V/M]** key return to normal operation.

CH	Frequency
A1	162.550 MHz
A2	162.400 MHz
A3	162.475 MHz
A4	162.425 MHz
A5	162.450 MHz
A6	162.500 MHz
A7	162.525 MHz
A8	161.650 MHz
A9	161.775 MHz
A10	163.275 MHz



For additional details on the following functions, refer to the Advanced Manual which may be downloaded from the Yaesu website.

Skip Memory Channel and Specified Memory Channel

Two types of memory channels may be designated, “skip memory channels” and “specified memory channels” for effective memory channel scanning.

Skip memory channels: Permits designating undesired channels to be skipped during scanning. Alternatively, you can specify that only designated memory channels are scanned during memory scanning.

Programmable Memory scan (PMS)

This function scans only the range of frequencies between the lower and upper limits registered in a pair of PMS Programmable Memory channels. 50 sets of PMS memory channels (L1/U1 to L50/U50) are available.

Dual Receive (DW) feature

The transceiver checks for signals on the frequency registered to the selected memory channel (Priority Memory Channel) once approximately every 5 seconds.

Using the WIRES-X Function

WIRES-X feature

WIRES (Wide-coverage Internet Repeater Enhancement System) is an Internet communication system which expands the range of amateur radio communication.

You may employ Internet communications by connecting from your transceiver to a WIRES-X local node station.



FT-70DR/DE does not accommodate the transmission/reception of messages, images, audio messages, or location information.

Connecting to a WIRES-X node in the C4FM mode (*Recommended)



- Ascertain the DSQ code or the DG-ID setting of the WIRES-X node station. Connecting to the WIRES-X node requires the transceiver DG-ID be set according to the DSQ code or the DG-ID code set on the WIRES-X node station.
- Confirm that the operating mode of WIRES-X node has been set to the C4FM digital mode.

1. Set the transmit/receive DG-ID to the same ID number as the local node station.
For more details on the DG-ID number, see “Communicating with the DG-ID feature” on page 19.
2. Transmit on the corresponding transmit/receive frequency.
 - If the signal is received from the node, continue to transmit using the DG-ID setting as is.
 - If the signal is not received from the node. ➡ proceed to “**Connecting to the other node ID or other room ID**”

Connecting to the other node ID or the other room ID

1. Press and hold the [F] key to enter the Setup Menu.
2. Rotate the **DIAL** knob to select “**63* (62) W-DGID**”, then press the [F] key. (*: USA Version)
3. Rotate the **DIAL** knob to set the WIRES-X DG-ID to the same ID number as the local node station.

Display	Description
DGID01 - 99	Only nodes matching the set DG-ID number may be connected.
AUTO (Default setting)	Only open nodes, set to the DG-ID number "00" may be connected.

4. Press the **PTT** switch, or press and hold [F] key to save the new setting and return to normal operation.
5. Press the [F] key, and then [AMS] key.
“WIRES” blinks.



- After successfully connecting to the node, one of the following screens (Lc / Cn) is displayed indicating the node status.

- **Node ID screen (the Node Lc screen)**

- This screen is displayed if the node is disconnected from the other node or the room on the Internet.

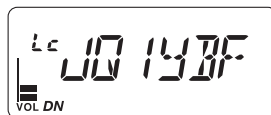

- The local node station's node ID is displayed.
- Continue to select a connecting node ➡ proceed to step 6

- **Connecting to a node ID or room ID screen (the Cn screen)**

- This screen is displayed when the node has been connected to a node or room on the Internet.
- The connecting node station's node ID is displayed.
- If not changing the connecting node/room ➡ proceed to step 7
- When changing the connecting node/room ➡ proceed to step 6

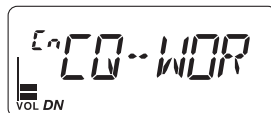

- If the node connection is not successful in 30 seconds, the beep sound is emitted and the transceiver returns to the normal operation.
- While "WIRES" is blinking, briefly press the [MODE] key to re-establish connection to the node station.

6. Rotate the **DIAL** knob to select one of the five screens (see below information), and connect to the desired node/room.

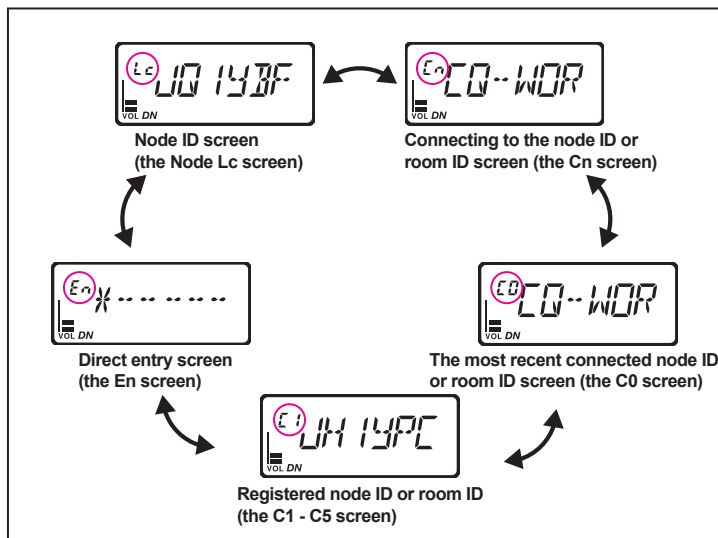

- **The most recent connected node ID or room ID screen (the C0 screen)**

Most recent connected node ID or room ID is displayed. A single press of the [AMS] key or PTT switch while this screen is displayed, will connect to the most recent node/room.

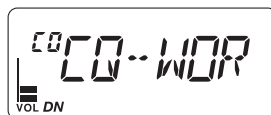

○ **Registered node ID or room ID screen (the C1 - C5 screen)**

- Rotate the **DIAL** knob to select a previously registered node/room (maximum 5 nodes/rooms) on the **C1 - C5** screen and, then press the **[AMS]** key or **PTT** switch to connect to the node/room.



- **Registering the node/room:**

Press and hold the **[1] - [5]** key to register the node/room (**C1 - C5**) on the connected node ID or room ID screen (**Cn**).

- **Cancelling the connected node/room:**

Select the node/room (**C1 - C5**) then press and hold the **[HM/RV]** key to delete the registered node/room.

○ **Direct entry screen (the En screen)**

Direct connection to a node or room may be made by inputting the other node ID or room ID (5 digits) manually.

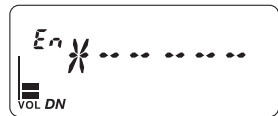

- Pressing the numeric keys (5 digits), and then press of the **[AMS]** key will request connection with another node ID or room ID.

- **Clearing the input node ID or room ID:**

Press and hold the **[HM/RV]** key

- **Cancelling the input node ID or room ID:**

Pressing the **[BAND]** key to return to the node ID screen (**Lc**) or the connecting node ID or room ID screen (**Cn**).



When a node has been connected, the node or room connection may be changed by inputting a different node ID or room ID.

When connecting to a node or room, **"CONNECT"** (CONNECT) is displayed on the screen, and the display is automatically switched to the connecting node ID or room ID screen (**Cn**).



In the case when the selected node or room is not connected, one of the following will be displayed on the screen.

"OFFLINE" (OFFLINE): Node or room is not in operation.

"BUSY": Another node is connecting.

7. Transmit to communicate with the WIRES-X Internet Link.

- Operations of the **[AMS]** key, **PTT** switch, **[BAND]** key, and **[VM]** key are described in the below chart.

Operation method (Operation screen)	Description
Press the [AMS] key or the PTT switch (C0 / C1 - C5 / En screen*)	Connect to the displayed node/room or change the destination connection. (*The PTT switch is disabled on the En screen)
Press and hold the [BAND] key (Lc / Cn / C0 / C1 - C5 / En Screen)	Disconnect from the connected node or room.

Press and hold the [1] to [5] key (Cn screen)	The connected node or room ID is registered to the memory of the number when it is pressed and held (In case the memory is already written, the registration is overwritten).
Press the [V/M] key (On activating WIRES-X)	Temporarily displays the operating frequency (when calling C4FM digital signal, the callsign of the other station is displayed). Press the [V/M] key again to return to the previous screen.

8. When communication is completed, press and hold the [MODE] key to exit WIRES-X mode.

● About WIRES-X open node stations

A listing of the WIRES-X open node stations, with their location, operation mode, etc. is posted on the Yaesu WIRES-X website.

<https://www.yaesu.com/jp/en/wires-x/index.php>

Connect and communicate with WIRES-X in analog mode

Confirm that the node station setting is in analog mode.

In analog mode, specify the connection destination using DTMF signals.

1. In the normal operating screen, press the [MODE] key to set the analog FM mode, and then tune to the frequency of the node station.



When DTMF function is set to "AUTO" (DTMF Icon displayed on the LCD), change to "MANUAL" using the following steps.

Press the [F] key → Press the [3](DTMF) key → Rotate the DIAL knob to select "MANUAL"
→ Press the PTT switch

2. While holding down the PTT switch on the microphone, press the [#](V/M) key and then enter the 5 digit ID number of the node or room to be connected, the DTMF code will be sent to the node station.
3. Keep the transceiver in receive mode for about 10 seconds. Once connection is established, you will be able to hear audio.



The connected destination screen will not appear.

4. Face the microphone and speak.

Disconnecting from the node or room

1. While pressing the PTT switch, then enter the "#99999" (DTMF disconnect command) keys.



In analog mode, the excellent C4FM features such as clear voice, digital information etc cannot be used, so we recommend using digital C4FM when communicating with the WIRES-X Internet Linking System.

Convenient Functions



For additional details on the following functions, refer to the Advanced Manual which may be downloaded from the Yaesu website.

Tone squelch feature

The tone squelch opens the speaker audio only when a signal containing the specified CTCSS tone is received. By matching the tone frequency with the partner station in advance, a quiet standby is possible.

Digital Code squelch (DCS) feature

DCS (Digital Coded Squelch) function that allows audio to be heard only when signals containing the same DCS code are received.

New PAGER (EPCS) feature

This new feature allows calling specified stations only, by using a pager code that combines two CTCSS tones. Even when the person who is called is not near the transceiver, the information is displayed on the LCD indicating that a call was received. When the call is received, the bell sounds. The transceiver is automatically placed in transmit mode (for about 2.5 seconds) when called by the other party, and notifies the other party that you are ready to communicate.

Digital Personal ID (DP-ID) feature

Digital Personal ID (DP-ID) feature opens the speaker audio only when a signal set to the same DP-ID in the Digital Mode is received.

Using Set Mode

The Set Mode permits configuring the various functions according to individual operating needs and preferences.

1. Press and hold the **[F]** key.
The previously selected Set Mode item is displayed.
2. Rotate the **DIAL** knob to select the desired Set Mode item.
3. Press the **[F]** key and then rotate the **DIAL** knob to change the setting.
4. Press the **PTT** switch to save the settings and return to normal operation.

On some setting screens, pressing the **PTT** switch does not exit from Set mode. In this case, press and hold the **[F]** key to return to the frequency display screen.

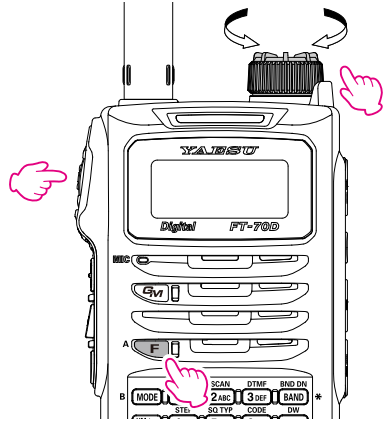

- In step 4 above, press the **[F]** key to save the new setting and return to Set Mode item to set the other Set Mode.
- On some setting screens, key operation is different than described in the above steps (For example, inputting the characters, etc.). Refer to the Advance manual.



For additional details, refer to the Advanced Manual which may be downloaded from the Yaesu website.

Display and Key Lamp Dimmer

The illumination level of the display and keys may be adjusted from the six levels.

Changing the Beep Volume

The volume of the key operation beep sound may be adjusted.

When rotating the DIAL knob to adjust the beep sound, the beeps will be heard. Adjust the sound to the desired level.

Automatic Power OFF (APO)

This function helps to prevent the battery draining by turning the transceiver OFF automatically if there is no operation for a certain period of time.

Time Out Timer (TOT)

Set the transceiver to automatically return to receive mode after transmitting continuously for a certain period of time. The TOT function limits inadvertent transmission of unnecessary signals, and unwanted battery power consumption.

Busy Channel Lock-Out (BCLO)

The BCLO feature prevents transmitting while a received signal strong enough to open the “noise” squelch is present (Set Mode [3 BCLO] 36)

Receiver Battery Save Function

Sets the Receive OFF Battery save interval (sleep ratio) to reduce power consumption.

Password Feature

A 4-digit password may be set to prevent unauthorized operation of the transceiver without permission. Once a password is set, the transceiver cannot be used unless the valid password is entered.

Tables of Set Mode Operations

No.	Set Mode item	Description	Selectable options (Options in bold are the default settings)
1	ANT.ATT	Switch the attenuator between ON/OFF.	OFF / ON
2	APO	Set the length of time until the transceiver turns off automatically.	OFF / 0.5 Hours to 12 Hours
3	BCLO	Turns the busy channel lockout function on/off.	OFF / ON
4	BEEP	Sets the beep sound function.	OFF / KEY+SC / KEY
5	BEP.LVL	Beep volume setting	LEVEL1 – LEVEL4 – LEVEL7
6	BEP.EDG	Sets the beep sound ON or OFF when a band edge is encountered.	OFF / ON
7	BEP.STB	Sets the beep sound ON or OFF when the other station completes transmission in the Digital Mode.	OFF / ON
8	BELL	Set the bell function settings.	OFF / 1 T–20 T / CONT (Continuous ringing)
9	BNK.NAM	Assign a name to each memory bank.	(up to 6 characters)
10	BSY.LED	Turn the MODE/STATUS Indicator ON or OFF while receiving signals.	LED.OFF / LED.ON
11	CLK.SFT	Set the clock shift function.	A / B
12	DC VLT	Display the voltage.	(Voltage)
13	DCS.INV	Select a combination of DCS inversion codes in terms of communication direction.	RXN.TXN / RXR.TXN / RXB.TXN / RXN.TXR / RXR.TXR / RXB.TXR
14	DIMMER	Set the brightness level of the LCD back light and numeric keypad light.	LEVEL1 – LEVEL6
15	DIG.POP	Set the POP UP display time.	OFF / 2 SEC – 10 SEC – 60 SEC / CONT
16	DIG VW	Turn the VW mode selection ON or OFF.	ON/ OFF
17	DP-ID	DP-ID list (Display/Register/Clear)	(Registered DP-ID)
18	DT DLY	Set the DTMF code transmission delay time.	50MS / 250MS / 450MS / 750MS / 1000MS
19	DT SET	Select and edit the DTMF auto dialer memory channel.	CH0 / CH1 – CH9
20	DT SPD	Set the DTMF code transmission speed.	50 MS / 100 MS
21	DW INT	Set the priority memory channel monitoring interval during Dual Receive.	0.1 S – 5.0 S – 10.0 S
22	DW RSM	Configure the scan stop mode settings for Dual Receive.	2.0 S – 10.0 S / BUSY / HOLD
23	DW RVT	Turn the “Priority Channel Revert” feature ON or OFF during Dual Receive.	OFF / ON
24	GM RNG	Select the beep option while receiving digital GM information.	OFF / IN RNG / ALWAYS
25	GM INT	Set the transmission interval of digital GM information.	OFF / NORMAL / LONG
26	HM/RV	Select the function of the [HOME/REV] key.	HOME / REV
27	HM-VFO	Turn transfer VFO to the Home channel ON or OFF.	OFF / ON
28	LAMP	Set the duration time of the back light and keys to be lit.	OFF / 2 SEC – 5 SEC – 10 SEC / CONT
29	LED.LGT	Turn ON the LED light.	(LED lights up)
30	LOCK	Configure the lock mode setting.	KEY / DIAL / K+D / PTT / K+P / D+P / ALL
31	MCGAIN	Adjust the microphone gain level.	LEVEL1 – LEVEL5 – LEVEL9

No.	Set Mode item	Description	Selectable options (Options in bold are the default settings)
32	M/T-CL	Select the function of the [MONI/T-CALL] switch.	MONI / T-CALL* (*: European / Asian Version)
33	MEM.NAM	Input the memory channel tag.	(Up to 6 letters)
34	MW MOD	Set the automatic channel number increment when registering to a memory channel.	LOWER / NEXT
35	NM/FRQ	Select the memory channel tag display or frequency display	FREQ / ALPHA
36	OPN.MSG	Select the Opening Message that appears when the transceiver is ON.	OFF / MSG / DC
37	PAG.ABK	Turn the pager answer back Function ON/OFF	OFF / ON
38	PAG.CDR	Specify a personal code (receive).	01 – 05 – 50, 01 – 47 – 50
39	PAG.CDT	Specify a personal code (transmit).	01 – 05 – 50, 01 – 47 – 50
40	PASSWD	Turn the password function ON or OFF.	OFF / ON
41	PSWDWT	Input the password.	(four digits)
42	PTT.DLY	Set the PTT delay time.	OFF / 20 MS / 50 MS / 100 MS / 200 MS
43	RAD ID	Display the transceiver specific number (5 digits alphanumeric ID). (Uneditable)	(Radio ID display)
44	RF SQL	Adjusts the RF Squelch threshold level.	OFF / S1 – S9
45	RPT.ARS	Turn the ARS function on/off.	OFF / ON
46	RPT.FRQ	Set the repeater shift width.	0.00M – 150.00M
47	RX MOD	Select the receive mode.	AUTO / FM / AM
48	RX SAVE	Set the battery save time.	OFF / 0.2 S – 60.0 S
49	SCM.WTH	Set the memory scan frequency range.	ALL / BAND
50	SCV.WTH	Set the VFO scan frequency range.	ALL / BAND
51	SCN.LMP	Set the scan lamp ON or OFF when scanning stops.	OFF / ON
52	SCN.RSM	Configure the scan stop mode settings.	2.0 S – 5.0 S – 10.0 S / BUSY / HOLD
53	SCN.STR	Set the scanning restart time.	0.1 S – 2.0 S – 10.0 S
54	SQL.EXP	Set a squelch type separately for Receive and transmit.	SPL.OFF / SPL.ON
55	TEMP	Indicates the current temperature inside the transceiver	(temperature display)
56	TOT	Set the timeout timer.	OFF / 0.5M – 3.0M – 10.0 M
57	TS MUT	Turn the muting function on/off during tone search.	OFF / ON
58	TS SPD	Select a tone search speed.	FAST / SLOW
59	VER.INF	Display the CPU and DSP firmware version of the transceiver.	(C x.xx) / (D x.xx) *Rotate DIAL knob to select
60	VFO.MOD	Set the frequency setting range in the VFO mode by DIAL knob.	ALL / BAND
61*	WX ALT	Turn the weather alert scan on/off. (This menu item is only available in the USA version.)	OFF / ON
62* (61)	W/N.DEV	Set the Transmit Modulation Level.	WIDE / NARROW
63* (62)	W-DGID	Setting of the WIRES-X DG-ID.	AUTO / DGID01 – DGID99
64* (63)	MYCALL	Set the call sign.	(up to 10 characters)

*: USA Version.

Restoring to Defaults (Reset)

All Reset

To restore all transceiver settings and memory content to the factory defaults.

CAUTION!

Resetting the transceiver will clear all memories.
Please make a note of the memories (memory channel settings, etc) before resetting.

1. Turn the transceiver **OFF**.
2. Press and hold the **[MODE]** key, the **[HM/RV]** key and the **[AMS]** key and turn the transceiver **ON** simultaneously.

The beep sounds and the confirmation screen is displayed.

3. Press the **[F]** key.
 - The beep will sound, and the transceiver will reset all factory defaults.
 - After resetting all defaults, the call sign input message appears on the LCD. Set the call sign ( 14).

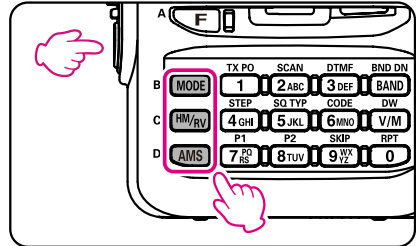

To cancel the resetting, press any key except the **[F]** key.

Set Mode Reset

All the Set mode only, settings can be restored to the default settings.

1. Turn the transceiver **OFF**.
2. Press the **[MODE]** key and the **[V/M]** key and turn the transceiver **ON** simultaneously.

The beep sounds and the confirmation screen is displayed.

3. Press the **[F]** key then the beep sounds and all Set mode settings are reset to defaults.

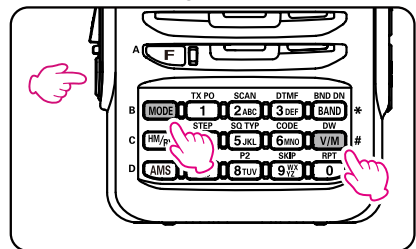

Perform All Reset to restore all of the following Set Mode items to default.

1 ANT.ATT	8 BELL	9 BNK.NAM	11 CLK.SFT	13 DCS.INV
17 DP-ID	19 DT SET	33 MEM.NAM	35 NM/FRQ	36 OPN.MSG
37 PAG.ABK	38 PAG.CDR	39 PAG.CDT	41 PSWDWT	44 RF SQL
46 RPT.FRQ	47 RX MOD	49 SCM.WTH	50 SCV.WTH	54 SQL.EXP
62* (61) W/N.DEV	64* (63) MYCALL			

*: USA Version



To cancel the resetting, press any key except the **[F]** key.

● General

Frequency Range :	RX	108-137 MHz 137-174 MHz 174-222 MHz 222-420 MHz 420-470 MHz 470-580 MHz
	TX	144-148 MHz, 430-450 MHz (USA version) 144-146 MHz, 430-440 MHz (European version) 140-174 MHz, 420-470 MHz (Asian version) (amateur band only)
Channel Steps:		5/6.25/(8.33)/10/12.5/15/20/25/50/100 kHz () Air Band
Mode of Emission:		F2D, F3E, F7W
Frequency Stability:		±2.5ppm (-20 °C to +60 °C [-4 °F to +140 °F])
Antenna Impedance:		50Ω
Supply Voltage:		Nominal: 7.4 V DC, Negative Ground SBR-24LI, Operating: 6.0 - 14 V DC, Negative Ground (Battery Connect) 11 - 16 V DC, Negative Ground (EXT DC JACK, Charging)
Current		180 mA (Receive VOL Level 16)
Consumption(Approx.):		120 mA (Standby, Saver Off) 70 mA (Standby, Saver 1 : 5 On) 400 μA (POWER OFF (APO)) 1.6 A (5 W TX, 144 MHz 7.4 V DC) 1.9 A (5 W TX, 430 MHz 7.4 V DC) 400 μA (Auto Power Off)
Operating Temperature:		-20 °C to +60 °C (-4 °F to +140 °F)
Case Size (W × H × D):		60×98×33 mm (2.36" × 3.86" × 1.30") (with SBR-24LI, w/o knob, antenna & belt clip) 60×98×31 mm (2.36" × 3.86" × 1.22") (w/o SBR-24LI, knob, antenna & belt clip)
Weight (Approx.):		255 g (8.99 oz) (with SBR-24LI & Antenna)

● Transmitter

Output Power:	5.0 W (High) / 2.0 W (Middle) / 0.5 W (Low) (@ 13.8 V or SBR-24LI)
Modulation Type:	F2D, F3E: Variable Reactance F7W: 4 FSK (C4FM)
Maximum Deviation:	±5 kHz
Spurious Emission:	USA/Asian version At least 60 dB below (@TX Power High, Middle) At least 50 dB below (@TX Power Low) European version At least 60 dB below (@TX Power High, Middle) At least 55 dB below (@TX Power Low)
Microphone Impedance:	2 kΩ

● Receiver

Circuit Type:	Double-conversion super heterodyne	
Intermediate Frequency:	1st: 47.25 MHz	2nd: 450 kHz
Sensitivity:	108 - 137 MHz (AM)	1.5 μ V typ @10 dB SN
	137 - 174 MHz (NFM)	0.16 μ V @12 dB SINAD
	174 - 222 MHz (NFM)	1 μ V @12 dB SINAD
	300 - 350 MHz (NFM)	0.5 μ V @12 dB SINAD
	350 - 400 MHz (NFM)	0.2 μ V @12 dB SINAD
	400 - 470 MHz (NFM)	0.18 μ V @12 dB SINAD
	470 - 580 MHz (NFM)	0.35 μ V @12 dB SINAD
	Digital Mode	0.19 μ V typ @BER1%
Selectivity (-6 dB/-60 dB):	NFM, AM 12 kHz / 35 kHz	
AF Output:	700 mW (16 Ω for THD 10 % 7.4 V DC) internal speaker	
	300 mW (8 Ω for THD 10 % 7.4 V DC) internal speaker	

Specifications are subject to change without notice, and are guaranteed within the 144 and 430 MHz amateur bands only. Frequency ranges will vary according to transceiver version; check with your dealer.

EU Declaration of Conformity

We, Yaesu Musen Co. Ltd of Tokyo, Japan, hereby declare that this radio equipment FT-70DE is in full compliance with EU Radio Equipment Directive 2014/53/EU. The full text of the Declaration of Conformity for this product is available to view at <http://www.yaesu.com/jp/red>

ATTENTION – Conditions of usage

This transceiver works on frequencies that are regulated and not permitted to be used without authorisation in the EU countries shown in this table. Users of this equipment should check with their local spectrum management authority for licensing conditions applicable for this equipment.

					
AT	BE	BG	CY	CZ	DE
DK	ES	EE	FI	FR	UK
GR	HR	HU	IE	IT	LT
LU	LV	MT	NL	PL	PT
RO	SK	SI	SE	CH	IS
LI	NO	-	-	-	-

Disposal of Electronic and Electrical Equipment

Products with the symbol (crossed-out wheeled bin) cannot be disposed as household waste.

Electronic and Electrical Equipment should be recycled at a facility capable of handling these items and their waste by-products.

Please contact a local equipment supplier representative or service center for information about the waste collection system in your country.



- Changes or modifications to this device that are not expressly approved by YAESU MUSEN could void the user's authorization to operate this device.
- This device complies with part 15 of the FCC Rules. Operation is subject to the following two conditions: (1) This device may not cause harmful interference, and (2) this device must accept any interference including received, interference that may cause undesired operation.
- The scanning receiver in this equipment is incapable of tuning, or readily being altered, by the User to operate within the frequency bands allocated to the Domestic public Cellular Telecommunications Service in Part 22.
- The YAESU MUSEN is not responsible for any changes or modifications not expressly approved by the party responsible for compliance. Such modifications could void the user's authority to operate the equipment.
- The YAESU MUSEN is not responsible for any changes or modifications not expressly approved by the party responsible for compliance. Such modifications could void the user's authority to operate the equipment.

This device complies with Industry Canada license-exempt RSS standard(s). Operation is subject to the following two conditions: (1) this device may not cause interference, and (2) this device must accept any interference, including interference that may cause undesired operation of the device.

Le présent appareil est conforme aux CNR d'Industrie Canada applicables aux appareils radio exempts de licence. L'exploitation est autorisée aux deux conditions suivantes : (1) l'appareil ne doit pas produire de brouillage, et (2) l'utilisateur de l'appareil doit accepter tout brouillage radioélectrique subi, même si le brouillage est susceptible d'en compromettre le fonctionnement.

DECLARATION BY MANUFACTURER

The Scanner receiver is not a digital scanner and is incapable of being converted or modified to a digital scanner receiver by any user.

WARNING: MODIFICATION OF THIS DEVICE TO RECEIVE CELLULAR RADIOTELEPHONE SERVICE SIGNALS IS PROHIBITED UNDER FCC RULES AND FEDERAL LAW.

CAN ICES-3 (B) / NMB-3 (B)

This equipment has been tested and found to comply with the limits for a Class B digital device, pursuant to part 15 of the FCC Rules. These limits are designed to provide reasonable protection against harmful interference in a residential installation. This equipment generates, uses, and can radiate radio frequency energy; and, if not installed and used in accordance with the instructions, may cause harmful interference to radio communications. However, there is no guarantee that interference will not occur in a particular installation.

If this equipment does cause harmful interference to radio or television reception, which can be determined by turning the equipment off and on, the user is encouraged to try to correct the interference by one or more of the following measures:

- Reorient or relocate the receiving antenna.
- Increase the separation between the equipment and receiver.
- Connect the equipment into an outlet on a circuit different from that to which the receiver is connected.
- Consult the dealer or an experienced radio/TV technician for help.

YAESU

The radio

Copyright 2020
YAESU MUSEN CO., LTD.
All rights reserved.

No portion of this manual may be
reproduced without the permission of
YAESU MUSEN CO., LTD.

YAESU MUSEN CO., LTD.

Tennozu Parkside Building
2-5-8 Higashi-Shinagawa, Shinagawa-ku, Tokyo
140-0002 Japan

YAESU USA

6125 Phyllis Drive, Cypress, CA 90630, U.S.A.

YAESU UK

Unit 12, Sun Valley Business Park, Winnall Close
Winchester, Hampshire, SO23 0LB, U.K.

1809R-CY-1

Printed in Japan



E H O 5 1 M 2 0 2