

YAESU
The radio

C4FM/FM 144/430MHz
DUAL BAND DIGITAL TRANSCEIVER

FT3DR
FT3DE

Advance Manual



Contents

Digital Personal ID (DP-ID) feature	4
About the Digital Personal ID (DP-ID) feature	4
Registering the DP-ID of the other station.....	4
Deleting the registered DP-ID	5
Communicating with specified other station in the	
Analog FM mode	6
Selecting the Squelch Type in the Analog FM Mode	6
Tone squelch feature	7
Setting CTCSS Tone frequency.....	7
Searching for the CTCSS Tone transmitted by the other Station	8
Digital Code Squelch (DCS) feature	8
Setting the DCS CODE	9
Searching for the DCS Code Used by the Other Station	9
New Two-Tone CTCSS Pager Function	10
Using the Pager Function.....	10
Setting the Code for Your Station	10
Calling a Specific Station.....	11
Receiving “pager code” calls from a Remote Station (Standby Operation)...	11
Using the Pager Answer Back	11
Notification of a Call from a Remote Station by the Bell Function	12
User Programmed Reverse CTCSS Decoder	12
CAM (Club Channel Activity Monitor) function	13
Register memory channel to CAM group	13
Using the CAM function.....	14
Delete CAM group.....	15
Delete a registered memory channel from CAM group	15
Memory Channel List	16
The Memory Channel Only Mode	16
Using Memory Banks	17
Registering to Memory Banks	17
Open the Memory Bank display	18
Open Memory Bank Channels	18
Canceling a Memory Channel Registered in Memory a Bank.....	18
Assigning a Name to a Memory Bank	19
Split Memory	20
Setting Skip Memory Channel and Specified Memory Channel	21
Skipping Unwanted Scan Frequencies (Skip Search Memory)	21
Programmable Memory Channel Scan (PMS)	22
Registering to the Programmable Memory Channels	22
Performing Programmable Memory Channel Scan.....	22
Memory Bank Scanning	23

Contents

Memory Bank Link Scanning	23
Setting Bank Link	23
Performing Bank Link Scan.....	23
Dual Receive (D.RCV) Function	24
Registering the priority channel.....	24
Activating the Dual Receive (D.RCV) feature.....	25
Setting the Dual Receive (D.RCV) Resume Conditions.....	25
AF-DUAL Receive Function.....	26
DTMF Operation.....	27
Setting the DTMF Memory	27
Transmitting the Registered DTMF Code.....	27
Transmitting DTMF code automatically using DTMF memory	27
Manually Transmitting the DTMF Code.....	27
Using the GPS Function	28
The GPS Function	28
Activating the GPS Function	28
Displaying Position Information of Remote Stations in Digital Mode.....	28
Saving GPS Information (GPS Log Function).....	29
Checking Tracks on Your PC.....	30
GPS Screen Information and Operation.....	31
Smart Navigation Function.....	32
Real-Time Navigation Function	32
Backtrack Function.....	33
Appendix	35
The folder configuration of the micro-SD card.....	35
Preset receiver channel lists.....	36
Recall a preset receiver.....	36
Weather Broadcast Stations (10 channels).....	37
International VHF Marine Radio (57 channels)	38
International World Wide Broadcast (89 channels)	39
All Reset.....	40
Set Mode Reset.....	40
Functions to Use as Necessary	41
Using the Transceiver for Packet Communication.....	41
Clone Operation.....	42
Connecting to a PC	43
Updating the FT3DR/DE firmware.....	43
In case of a malfunction.....	44

Digital Personal ID (DP-ID) feature

About the Digital Personal ID (DP-ID) feature

When operating in digital C4FM communications, each transceiver is programmed with, and sends its own individual ID information (Radio ID) in each transmission. The DP-ID function and the individual identification information, makes possible group communications of stations that are within communications range.

Digital Personal ID (DP-ID) feature opens the speaker audio only when a signal set to the same DP-ID in the Digital Mode is received, even if each transceiver is set a different Digital Group ID (DG-ID) number.

The digital C4FM repeater equipped with the DP-ID function allows preferentially contact in an emergency, regardless of the repeater setting or if the repeater is being used without the DG-ID setting.



- Digital C4FM mode transceivers compatible with the DG-ID function are required in order to utilize this function.
- If the firmware is not compatible with the DG-ID function, update to the latest firmware to use the DG-ID function. The latest firmware is available on the YAESU website.

Registering the DP-ID of the other station



- Once registered, DP-ID is stored until deleted.
- Register with each other's transceivers nearby.
- When setting the DG-ID code to "00", the transceiver will receive signals from all digital C4FM stations. To utilize the DP-ID function, it is necessary to set the receive DG-ID code to a number other than "00".

1. Press and hold the **[DISP]** key → touch **[GM]** → touch **[1 DP-ID LIST]**.

- The DP-ID list is displayed.
- If a number of DP-IDs are registered, rotate the **DIAL** knob to display the desired DP-ID.



2. A transmission in the digital C4FM mode from the other transceiver will register the DP-ID.

When a signal from the other station is received, the callsign and "**REGISTRATION?**" are displayed on the LCD.



- When a signal from another registered transceiver is received, nothing is display on the LCD.
- When registering a transceiver already registered with a different call sign, the call sign registered in the DP-ID list is changed to the new registered call sign.

3. Touch **[OK]** to save the setting.
 - When registering in the DP-ID list is finished, “COMPLITED” is displayed for three seconds, then the display returns to the DP-ID list screen.
 - If not registering the DP-ID, press the **[CANCEL]**.
 - If registering several DP-IDs, repeat step 2 and 3.
 - A maximum of 24 stations may be registered.
4. Press the **PTT** switch to save the setting and return to normal operation.
 - Similarly, register all of the communicating transceivers’ DP-IDs to the DP-ID lists of the other stations.
 - The DP-ID setting is complete.



For communicating using the DP-ID function, register the DP-ID of each other’s transceiver on both transceivers. By registering the DP-ID, users may communicate even if the Digital group ID (DG-ID) is a different setting

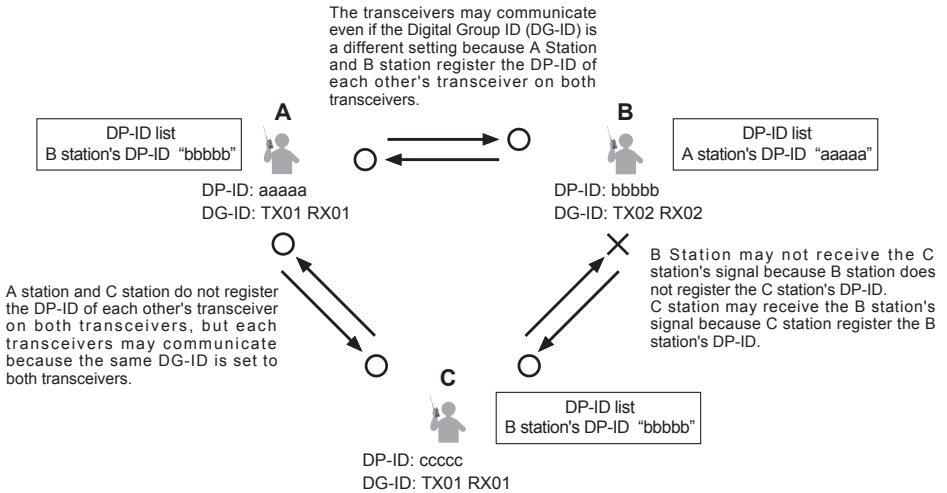

Deleting the registered DP-ID

1. Press and hold the **[DISP]** key → touch **[GM]** → touch **[1 DP-ID LIST]**.

The DP-ID list is displayed.



2. Rotate the **DIAL** knob to select the call sign of the other transceiver, then touch **[DEL]**.

Confirmation screen “DELETE?” is displayed.



3. Touch **[OK]** to delete.
 - When finished registering in the DP-ID list, “COMPLETED” is displayed for three seconds.
 - If not registering another DP-ID, touch **[CANCEL]**.
 - If deleting several DP-IDs, repeat step 2 and 3.
4. Press the **PTT** switch to save the setting and return to normal operation.

Communicating with specified other station in the Analog FM mode

Selecting the Squelch Type in the Analog FM Mode

1. Touch **[F MW] → [GM]**.
If **[SQTYP]** is not displayed, touch **[FWD →]** to display **[SQTYP]** and then touch it.



2. Turn the **DIAL** knob and select the type of squelch, refer to the table below.



Tone squelch (CTCSS), DCS and the New PAGER (EPCS) functions do not operate in the C4FM digital mode. Touch **[MODE]** to change to the Analog FM mode, or turn the AMS function ON.

Squelch type	Icon indication	Description
OFF	—	Deactivates the tone squelch function and DCS function OFF, then returns to the normal squelch operation in the Analog FM mode.
TONE	TN	Analog FM Transmissions contain the CTCSS tone. Receives as a normal squelch operation.
TONE SQL	TSQ	Activates the CTCSS tone squelch function on Analog FM receive.
DCS	DCS	Activates the Digital Code Squelch (DCS) function. The DCS code may be selected from 104 codes (from 023 to 754).
REV TONE	RTN	Activates the reverse tone function. Used to monitor communications based on the squelch control system. When a signal contains the designated tone, the squelch is not opened, and when the tone signal disappears, the squelch opens, and communication starts.

Squelch type	Icon indication	Description
PR FREQ	PR	Activates the no-communication squelch function for radios. The no-communication signal tone frequencies may be specified within the range from 300 Hz to 3000 Hz in steps of 100 Hz.
PAGER	PAG	Activates a new two-tone CTCSS pager function. When communicating with FT3DR/DE transceivers among friends, specify personal codes (each code is composed of two tones) so that only specific stations are called.
D CD*	DC	Transmits the signal containing the DCS CODE. Receives as a normal squelch operation.
TONE-DCS*	T-D	Sends a tone signal when transmitting, and receives the only signal matches the DCS code when receiving.
D CD-TONE SQL*	D-T	Sends the DCS CODE when transmitting and receives only signals that contain a matching tone signal when receiving.

*: Press and hold the **[DISP]** key → **[SIGNALING]** → **[10 SQL EXPANTION]** set to “ON”, “D CD”, “TONE-DCS” and “D CD-TONE SQL” setting values are activated.

3. Press the **PTT** switch to save the settings and return to normal operation.

- The squelch type may be set for each frequency band (BAND).
- The CTCSS and DCS squelch settings are also active during scanning. If scanning is performed with the CTCSS and DCS squelch function activated, scanning stops only when a signal containing the specified CTCSS tone or DCS code is received.
- Pressing the MONI/T-CALL switch allows signals that do not contain a tone or DCS code, and signals with different tones, DCS codes, digital mode signals to all be heard.
- Press and hold the **[DISP]** key → **[SIGNALING]** → **[DCS INVERSION]** allows to receive the DCS code of the inverted phase.



Tone squelch feature

The tone squelch opens the speaker audio only when a signal containing the specified CTCSS tone is received. The receiver will be quiet while waiting for a call from a specific station.



The tone squelch function does not function in digital mode. Touch **[MODE]** to change the communication mode to Analog FM mode or turn the AMS function ON.

Setting CTCSS Tone frequency

The tone frequency may be selected from 50 frequencies (from 67.0 Hz to 254.1 Hz).

1. Touch **[F MW]** → **[SQTYP]**.

If **[SQTYP]** is not displayed, touch **[FWD →]** to display **[SQTYP]** and then touch it.

2. Rotate the **DIAL** knob to select “**TONE SQL**”.

3. Press the **PTT** switch to save the settings and return to normal operation.

4. Touch **[F MW]** → **[CODE]**.
5. Rotate the **DIAL** knob to select the tone frequency.
6. Press the **[BACK]** key to save the setting and return to normal operation.

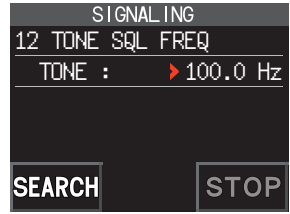

- The tone frequency setting is common with the squelch types as follows: TONE, TONE SQL, REV TONE, TONE-DCS, D CD-TONE SQL
- The default setting is “100.0 Hz”

Searching for the CTCSS Tone transmitted by the other Station



The tone search function does not function in digital mode. Touch **[MODE]** to change the communication mode to Analog FM mode or turn the AMS function ON.

Search and display the tone squelch CTCSS tone transmitted by the other station.

1. Touch **[F MW]** → **[SQTYP]**.
If **[SQTYP]** is not displayed, touch **[FWD →]** to display **[SQTYP]** and then touch it.
2. Rotate the **DIAL** knob to select the “TONE SQL”.
3. Press the **PTT** switch to save the setting and return to normal operation.
4. Touch **[F MW]** → **[CODE]**.

The setting screen of the tone frequency is displayed.

5. Touch **[SEARCH]**.
 - The transceiver begins searching for a matching tone frequency.
 - When a corresponding tone frequency is detected, a beep sound is emitted, and the detected tone frequency blinks. The searching stops for 5 seconds and the audio is heard.

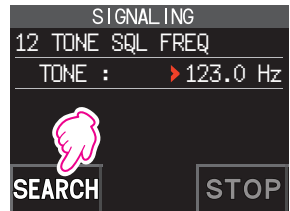

6. Touch **[STOP]** to stop searching.
7. Press the **[BACK]** key to save the detected tone frequency and return to normal operation.



To set the transceiver operation when scanning stops, press and hold the **[DISP]** key → **[SCAN]** → **[4 SCAN RESUME]**. This setting is common with the scan setting, tone search function and DCS search function.

Digital Code Squelch (DCS) feature

The Digital Code Squelch opens the speaker audio only when a signal containing the specified DCS code is received.

The DCS code may be selected from 104 types (from 023 to 754).



The tone search function does not function in digital mode. Touch **[MODE]** to change the communication mode to Analog FM mode or turn the AMS function ON.

Setting the DCS CODE

1. Touch **[F MW]** → **[SQTYP]**.

If **[SQTYP]** is not displayed, touch **[FWD →]** to display **[SQTYP]** and then touch it.

2. Rotate the **DIAL** knob to select “DCS”.

3. Press the **PTT** switch to save the setting and return to normal operation.

4. Touch **[F MW]** → **[CODE]**.

5. Rotate the **DIAL** knob to select the DCS code.

6. Press the **[BACK]** key to save the detected tone frequency and return to normal operation.

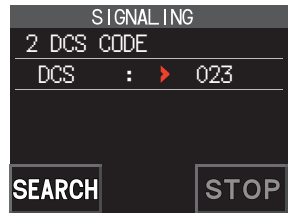

- The DCS code set by the above operation is the common setting for all transmissions with a DCS Code (DCS, D CODE, T DCS, D TONE).
- The default DCS code is “023”.

Searching for the DCS Code Used by the Other Station

Search for the DCS code used by the other station.

1. Touch **[F MW]** → **[SQTYP]**.

If **[SQTYP]** is not displayed, touch **[FWD →]** to display **[SQTYP]** and then touch it.

2. Rotate the **DIAL** knob to select “DCS”.

3. Press the **PTT** switch to save the setting and return to normal operation.

4. Touch **[F MW]** → **[CODE]**.

The DCS code setting screen is displayed.

5. Touch **[SEARCH]**.

- The transceiver starts to search for the DCS code.
- When a corresponding DCS code is detected, a beep sound is emitted. The detected DCS code blinks. The searching stops for 5 seconds and the audio is heard.

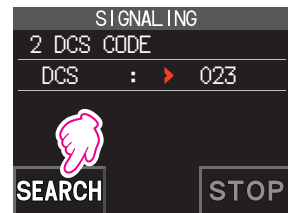

6. Touch **[STOP]** to stop searching.

7. Press the **[BACK]** key to save the detected DCS code and return to normal operation.



To set the transceiver operation when scanning stops, press and hold the **[DISP]** key → **[SCAN]** → **[4 SCAN RESUME]**. This setting is common for all scan settings, the tone search function and DCS search function.

New Two-Tone CTCSS Pager Function

When using FT3DR/DE transceivers with a group of friends, setting the Two-Tone CTCSS personal codes allows calling just the specific stations. Even when the person who is called is not near the transceiver, the information on the LCD indicates that a call was received.



The new two-tone CTCSS pager feature does not operate in digital mode. Touch **[MODE]** to change the communication mode to Analog FM mode or turn the AMS function ON.

Using the Pager Function

1. Touch **[F MW]** → **[SQTYP]**.
If **[SQTYP]** is not displayed, touch **[FWD →]** to display **[SQTYP]** and then touch it.
2. Rotate the **DIAL** knob to select the “PAGER”.
3. Press the **PTT** switch to save the setting and return to normal operation.

Setting the Code for Your Station

Set the “pager code” to be called by other stations.

1. Activate the pager function by referring to “Using the pager function” above.
2. Touch **[F MW]** → **[CODE]**.
If **[CODE]** is not displayed, touch **[FWD →]** to display **[CODE]** and then touch it.
3. Rotate the **DIAL** knob to select “**CODE-RX**”.

SIGNALING	
6 PAGER	
ANS-BACK :	OFF
▶ CODE-RX :	05 47
CODE-TX :	05 47

4. Press the **[DISP]** key to move the “▶” icon to the first element of the code.
Rotate the **DIAL** knob to select the first element of the code from 1 to 50.

SIGNALING	
6 PAGER	
ANS-BACK :	OFF
CODE-RX :	▶05 47
CODE-TX :	05 47

5. Press the **[DISP]** key to move the “▶” icon to the second element of the code.
Rotate the **DIAL** knob to select the second element of the code from 1 to 50.
The same code cannot be use for both elements.

SIGNALING	
6 PAGER	
ANS-BACK :	OFF
CODE-RX :	05 ▶47
CODE-TX :	05 47

6. Press the **PTT** switch to save the setting and return to normal operation.



- The reverse combination works as the same code, that is “05 47” is the same as “47 05”.
- If the same code is specified for all individuals, all the individuals can be called at the same time.
- The default code is “05 47”.
- When receiving the signals, the intermittent sound of the tone signal may be heard slightly.

Calling a Specific Station

The “pager code” may be set to call specific stations.

1. Activate the pager function by referring to “Using the Pager Function” (page 10).
2. Touch [F MW] → [CODE].
If [CODE] is not displayed, touch [FWD →] to display [CODE] and then touch it.
3. Rotate the **DIAL** knob to select “**CODE-TX**”.
4. Press the [DISP] key to move the “▶” icon to the first element of the code.
Rotate the **DIAL** knob to select the first element of the code from 1 to 50.
5. Press the [DISP] key to move the “▶” icon to the second element of the code.
Rotate the **DIAL** knob to select the second element of the code from 1 to 50.
The same code cannot be use for both elements.
6. Press the **PTT** switch to save the setting and return to normal operation.
7. Press the **PTT** switch to transmit a call to the specific station.

Receiving “pager code” calls from a Remote Station (Standby Operation)

When the Pager function is activated, and a call is received with a corresponding Code, the audio is heard. When the PTT switch is pressed, the “**PAG**” icon blinks and the other station's audio is heard regardless of whether the code matches or not. About 10 seconds after the signal disappears, the “**PAG**” icon will light, and the sound of the unmatched signal will not be heard.

Furthermore, when the Bell function (see below) is activated, the bell rings and the “” icon blinks when receiving calls from the other station.

Using the Pager Answer Back

when called by another station with a corresponding pager code, the transceiver is automatically placed in the transmit mode (for about 2.5 seconds) to notify the other station that you are ready to communicate.

1. Activate the pager function by referring to “Using the Pager Function” (page 10).
2. Touch [F MW] → [CODE].
If [CODE] is not displayed, touch [FWD →] to display [CODE] and then touch it.
3. Press the [DISP] key, and then rotate the **DIAL** knob to select “ON”.

SIGNALING	
6	PAGER
ANS-BACK :	▶ ON
CODE-RX :	05 47
CODE-TX :	05 47

4. Press the **PTT** switch to transmit a call to the specific station.

Notification of a Call from a Remote Station by the Bell Function

The Bell may be set to sound an Alert when a call from another station containing a corresponding tone, DCS or pager code is received. “📞” icon on the display blinks to provide a later notice of the call from the other station.

1. Press and hold the [DISP] key → touch [SIGNALING] → [1 BELL].
2. Press the [DISP] key.
3. Rotate the DIAL knob to select “BELL”.
4. Press the [BACK] key, and then rotate the DIAL knob to select “RINGER”, and then press the [DISP] key.
5. Rotate the DIAL knob to select the desired number of times (1-20 times or continuous) the Bell rings.
••• 1time ↔ 2times ↔ ••• ↔ 20times ↔ CONTI •••
6. Press the PTT switch to save the setting and return to normal operation, and the “📞” icon appears on the display.

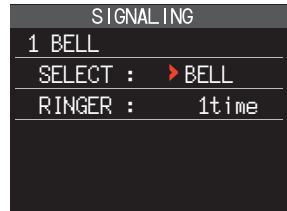

If the setting is “CONTI” (continuous), the bell keeps sounding until an operation is made.

User Programmed Reverse CTCSS Decoder

The tone signal frequency can be set at 100 Hz intervals between 300 Hz and 3000 Hz to mute the audio when receiving a signal containing a CTCSS tone matching the programmed tone.

1. Touch [F MW] → [SQTYP].
2. Rotate the DIAL knob to select “PR FREQ”.
3. Press the PTT switch to save the setting and return to normal operation.
4. Touch [F MW] → [CODE].
The setting screen containing the CTCSS tone frequencies is displayed.
5. Rotate the DIAL knob to select the desired CTCSS tone frequency.
300Hz to 3000Hz (100Hz steps)
6. Press the PTT switch to save the setting and return to normal operation.

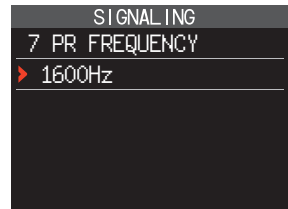

CAM (Club Channel Activity Monitor) function

Up to 10 groups with 5 channels each, of frequently used memory channels* may be registered, and then while receiving the current frequency, the status (signal strength) of the selected group of memory channels may be displayed. It is easy to identify on which channel the communication was made.

When a memory channel on the graph is touched, it will become the center operating frequency, so communication with friends may begin immediately.

* Only channels in the frequency range of 108 MHz to 579.995 MHz may be stored.

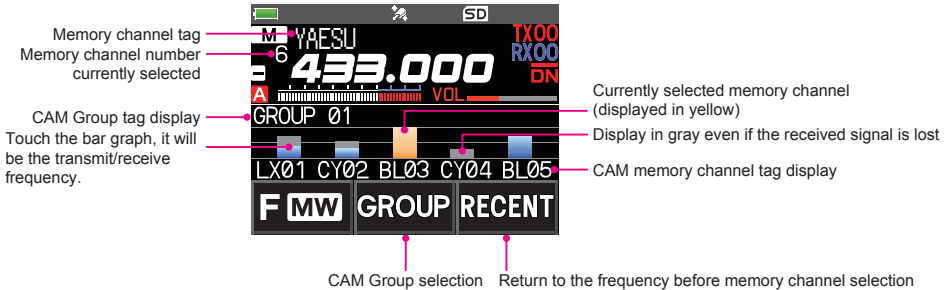

Register memory channel to CAM group

1. Touch **[F MW]** → **[CAM]**.
 - If **[CAM]** is not displayed, touch **[FWD →]** to display **[CAM]** and then touch it.
 - The CAM screen is displayed.
2. Touch **[GROUP]**, and then turn the **DIAL** knob to select the group (CAM1 to 10) to be registered.

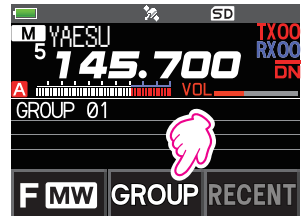

3. Touch **[MEMBER]**.
A list of memory channels registered to the CAM group is displayed.



4. Touch **[ADD]**.



- Rotate the **DIAL** knob to select the memory channel to register, and touch **[ENT]**.
 - Repeat step 5 to register multiple memory channels.
 - Up to 5 channels can be registered in one group.
- Press the **[BACK]** key to return to the CAM screen.

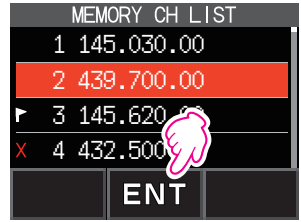

● Changing the name (tag) of CAM group

Change the name of CAM group from the default setting.

- In step 2 of “Register memory channel to CAM group”, turn the **DIAL** knob to select the group to change the tag.
- Touch **[EDIT]** and enter up to 16 characters for the CAM group tag.

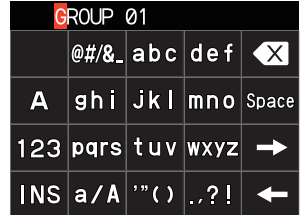

● Change the name (tag) of CAM memory

Change the name of Memory channels registered in the CAM group from the default setting.

- In step 3 of “Register memory channel to CAM group”, turn the **DIAL** knob to select the memory channel to change the tag.
- Touch **[EDIT]** and enter up to 4 characters for the CAM memory channel tag.

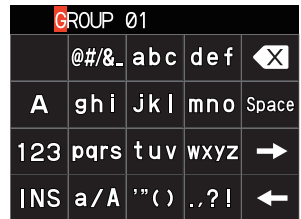

Using the CAM function

- Touch **[F MW] → [CAM]**.
 - If **[CAM]** is not displayed, touch **[FWD →]** to display **[CAM]** and then touch it.
 - The CAM screen is displayed, and the signal strength of the channel that received the signal is displayed as a bar graph.
 - On the channel that received the signal, the bar graph will continue to display in gray even if there is no signal, so later you can check the channel on which the communication was performed, and the maximum signal strength received later.

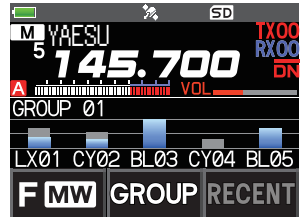

● Touch the bar graph to switch the frequency

- Touch the bar graph on the screen.
 - The touched bar graph is displayed in yellow and switched to the memory channel frequency and received.
 - Press the **PTT** switch to transmit as it is, so you can start communicating with the other station immediately.
 - Touch **[RECENT]** to return to the original frequency.

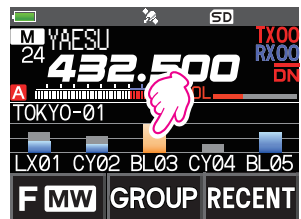

● **Change the displayed CAM group**

1. Touch **[GROUP]**.
2. Rotate the DIAL knob to select the CAM group (CAM1 to 5) to be displayed.
3. Press the **[BACK]** key to return to the CAM screen.



● **Disable the CAM function**

1. Press the **[BACK]** key.

Delete CAM group

1. Touch **[GROUP]** on the CAM screen, and then rotate the **DIAL** knob to select the CAM group (GROUP 01 to 10) to be deleted.

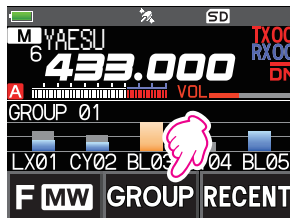

2. Touch **[DEL]**.
Confirmation screen “**DELETE?**” is displayed.
3. Touch **[OK]** twice.
 - The CAM group is deleted and the channel list is displayed again.
 - To cancel the deleting, touch **[CANCEL]**.



Delete a registered memory channel from CAM group

1. Touch **[GROUP]** on the CAM screen, and then touch the CAM group (GROUP 01 to 10) in which the memory channel to be deleted is registered.

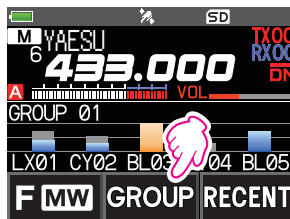

2. Touch **[MEMBER]**.
The memory channels registered in the group are displayed in a list.



3. Rotate the **DIAL** knob to select
4. Touch **[DEL]**.
Confirmation screen “**DELETE?**” is displayed.
5. Touch **[OK]** twice.
 - The memory channel is deleted from the CAM group and the list display returns.
 - To cancel the deleting, touch **[CANCEL]**.

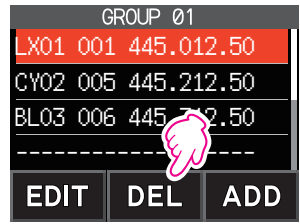

Memory Channel List

Since memory channels are displayed in a list, you can easily recall the memory by checking the frequency and memory tag display.

1. Touch **[F MW]** → **[MEMORY]**.
 - If **[MEMORY]** is not displayed, touch **[FWD →]** to display **[MEMORY]** and then touch it.
 - You can switch between memory tag display and frequency display by press and hold the **[V/M]** key.
 - The “X” icon is displayed at the left of memory channels set as skip memory, and the “▶” icon is displayed at the left of memory channels set as specified memory.

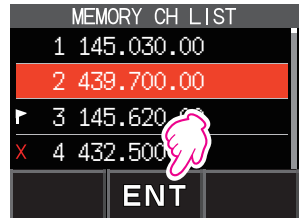

2. Rotate the **DIAL** knob to select the desired memory channel.
3. Touch **[ENT]** to recall the selected memory channel and enter memory mode.

The Memory Channel Only Mode

The FT3DR/DE may be set to operated only in the registered memory channels.

1. While pressing the **[V/M]** key, press and hold the POWER switch to turn the transceiver ON.
 - The memory channel only mode is ON, the previously selected memory channel is recalled.
 - Rotate the **DIAL** knob to select the memory channels.
 - Touch the frequency display to display the numeric keypad, enter a 3-digit memory channel number, and then touch **[ENT]** to recall the memory channel.
-
- In the memory only mode, only the following functions will operate:
 - Changing the communication mode (touch **[MODE]**)
 - The transmission mode setting of the AMS function (touch **[AUTO]**, **[TX FM]** or **[TX DN]**)
 - Group monitor (GM) function (press the **[GM]** key)
 - WIRES-X function (press the **[X]** key)
 - Audio level adjustment
 - SQL level adjustment (press the **[SQL]** key)
 - Key lock function (press the **POWER** switch)
 - Pressing the **[V/M]** key, will sound the beep, “**M-ONLY**” will be displayed, and the function will not operate.



● Canceling Memory Only Mode

1. Turn the transceiver OFF; and then while pressing the **[V/M]** key, press and hold the **POWER** switch to turn the transceiver ON.

Using Memory Banks

The transceiver allows using up to 24 memory banks to be recalled with the sorted memory channels. One memory channel may also be registered in two or more memory banks according to the intended use.

Example of registering memory channels to the memory banks:

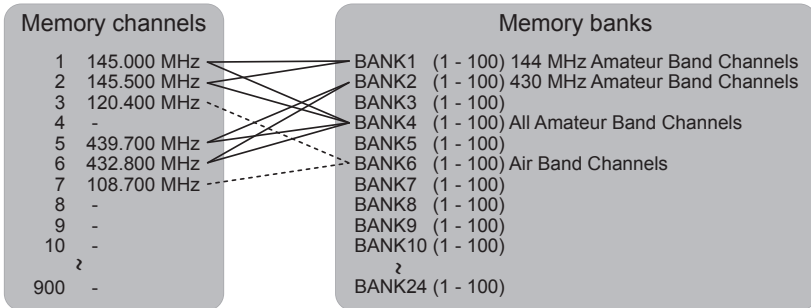

Registering to Memory Banks

1. Press the **[V/M]** key to enter the memory mode.
2. Rotate the **DIAL** knob to recall the memory channel to register in the memory bank.
3. Touch and hold **[F MW]**.
Memory channel will blink.
4. Rotate the **DIAL** to select the memory bank (BANK1 to BANK24) to register the memory channel.

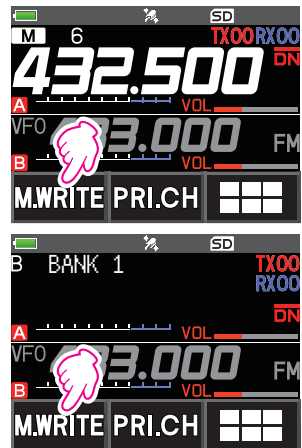

The memory bank channels are displayed between the memory channel 1 (1CH), and PMS memory channel U50.

5. Touch **[M.WRITE]**.
The memory channel is registered in the selected memory bank and the transceiver operation returns to the memory mode.

Open the Memory Bank display

1. Press the **[V/M]** key to enter the memory mode.

2. Touch **[F MW]** → **[BANK]**.

If **[BANK]** is not displayed, touch **[BACK ←]** to display **[BANK]** and then touch it.

B1 to B24: The memory bank display

[M]: The memory channel display

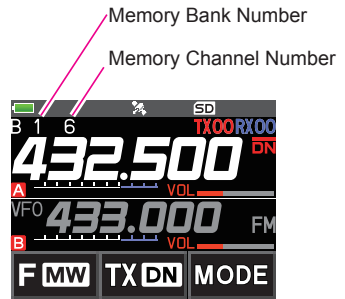

If no memory channel is registered, setting the following operation sounds the beep and “NO BANK” will be displayed.

● Disable the memory bank display

1. Touch **[F MW]** → **[MR]**.

If **[MR]** is not displayed, touch **[BACK ←]** to display **[MR]** and then touch it.

Open Memory Bank Channels

1. While the memory bank is displayed, press the **[BAND]** key.

2. Rotate the **DIAL** knob to select the memory bank (BANK1 to BANK24) to be recalled.



If no memory channel is registered, the memory bank may not be selected.

3. Press the **[BAND]** key or **PTT** switch.

The selected memory bank is activated.

Canceling a Memory Channel Registered in Memory a Bank

1. Recall the memory bank to cancel registering.

2. Touch and hold **[F MW]**.

3. Rotate the **DIAL** knob to select the memory channel to cancel registering to the memory channel.

4. Touch **[M.DEL]**, and then touch **[M.DEL]**.

Assigning a Name to a Memory Bank

A name can be assigned to a memory bank using up to 16 characters.

The following types of characters can be entered:

- Alphabetic characters (1 byte and 2 byte letters, uppercase and lowercase characters)
- Numbers (1 byte and 2 byte numbers)
- Symbols

1. Press and hold the **[DISP]** key → touch **[MEMORY]** → **[2 BANK NAME]**.
2. Touch the bank where you want to edit the tag.
 - The character input screen is displayed.
 - Use the numeric keys or **DIAL** knob, to input the name characters.
 - Touch **[→]**: to move the cursor to the right
 - For additional details on inputting a memory tag, refer to the Operating Manual “Text input screen” on page 89.

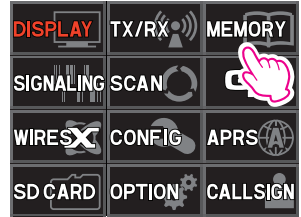

i The default memory bank names are set from “BANK 1” to “BANK24. Each name may be changed.

3. When input is complete, press the **PTT** switch to save the characters and return to normal operation.

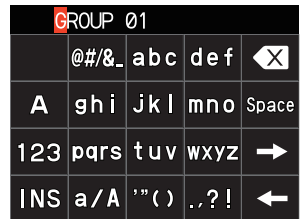

Split Memory

Two different frequencies, one for receive and another for transmit, may be registered to a memory channel.

1. Register the receive frequency to a memory channel first.
 - For additional details on registering to a memory channel, refer to the Operating Manual “Registering to Memory Channels”.
2. Set the transceiver to the desired transmit frequency.
3. Touch and hold [F MW].
4. Rotate the **DIAL** knob to select the channel number that the receive frequency was registered to on step 1.
5. While pressing and holding the **PTT** switch, press the [M.WRITE] key.
 - The beep sounds and the split memory is saved.
 - While recalling the split memory, “” is displayed on the LCD.

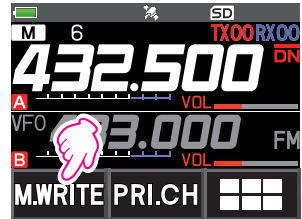

Registering the receive frequency.

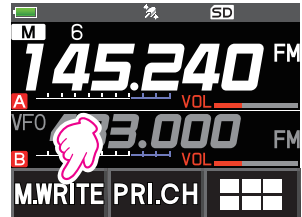

Registering the transmit frequency.

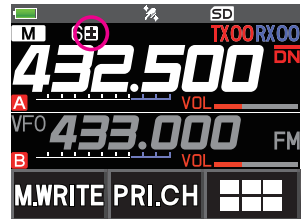

Recalling the split memory



While operating the split memory, touch [F MW] → [REV], to reverse the transmit and receive frequencies temporarily. When reversing the frequencies, “” will blink.

Setting Skip Memory Channel and Specified Memory Channel

For efficient memory channel scanning, two types of memory channels may be designated, “skip memory channels” and “specified memory channels”. Set “Skip Memory Channels” will be skipped during the memory scanning; and only “Specified Memory Channels” will be scanned during specified memory channel scanning.

1. Recall the memory channel to skip or specify.
2. Press and hold the [DISP] key → touch [MEMORY] → [5 MEMORY SKIP].

3. Rotate the **DIAL** knob to change as follows:

••• → OFF → SKIP X → SELECT ▶ → •••

- **SKIP:** Skip Memory Channel

The “X” at the right of the memory channel number lights up, and then the channel is skipped during scanning of memory channels.

- **SELECT:** Specified Memory Channel

The “▶” at the right of the memory channel number lights up, and then only designated memory channels are scanned during memory scanning.

- **OFF:** Normal Memory Channel

The “X” or “▶” at the right of the memory channel number turns OFF.

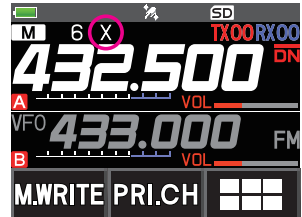

Skip Memory

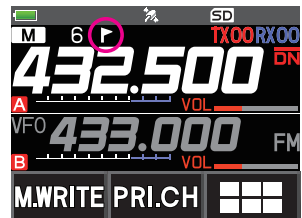

Specified Memory

● Scanning Only the Specified Memory Channels

1. Recall the memory channel registered as a specified memory channel.
2. Touch [F MW] → [SCAN].
 - If [SCAN] is not displayed, touch [BACK ←] to display [SCAN] and then touch it.
 - Only the memory channels registered as the specified memory channels are scanned.



Unless two or more specified memory channels are registered, the specified memory channel scanning does not function.

Skipping Unwanted Scan Frequencies (Skip Search Memory)

During the VFO scan, an unwanted frequency may be skipped by registering it to the “skip search memory channels” in advance.

● Set the temporary scan stop to the skip search memory

1. Press and hold the [F MW] key to temporarily stop the VFO scan.
2. Rotate the **DIAL** knob to select a skip search memory channel from 901-999.

Only skip search memory channels 901-999 may be selected.
3. Touch [M.WRITE].

The beep sounds, and the search skip channel is saved to memory, then the scan resumes.

● Specifying Unwanted VFO Scan Frequencies

1. In the VFO mode, set the frequency that you do not want to receive.
2. Register the skip search memory (901-999) with the same steps as “Registering to Memory Channels” (see the Operating Manual).



The skip search memory may be deleted with the same steps as “Clearing Memories” (see the Operating Manual). The deleted frequency is scanned again.

Programmable Memory Channel Scan (PMS)

Registering to the Programmable Memory Channels

50 sets of PMS memory channels (L1/U1 to L50/U50) are available.

- Register the lower and upper frequencies of the frequency range in a pair of Programmable Memory Channels.

L□□: Lower limit memory channel

U□□: Upper limit memory channel

- For more details on registering frequencies to the memory channel, see “Registering to Memory channels” (see the Operating Manual).

- Make sure to use the corresponding numbers for the lower and upper limit memory channels.



- Set the PMS memory channel for performing the Programmable Memory scanning (PMS) as follows:

- The scan width of the upper and lower limit frequencies must be 100 kHz or more.
- The lower and upper limit memory channels must be within the same frequency band.
- The lower and upper limit memory channels must not be registered in reverse.
- The PMS memory channel must not be registered as a skip memory channel.

Performing Programmable Memory Channel Scan

The programmable memory channel scan allows scanning a specified frequency range within the same frequency band.

1. Recall the PMS memory channel to which the lower limit (L□□) or upper limit (U□□) of the frequency band is registered.
2. Touch **[F MW]** → **[SCAN]**.

- If **[SCAN]** is not displayed, touch **[BACK ←]** to display **[SCAN]** and then touch it.
- Programmable memory channel scanning starts.
- During scanning, “**PMSP□□**” appears on the upper left side of the display.
- If the **DIAL** knob is rotated while scanning is in progress, the scanning will continue up or down in frequency according to the direction of the **DIAL** Knob rotation.

If the scanner halts on an incoming signal, the back light will turn ON and the decimal point between the “MHz” and “kHz” digits of the frequency display will blink.

Scanning will resume in about five seconds.

3. Touch **[STOP]** or press the **PTT** switch to cancel the scanning.
In this state (displayed as “**PMSP□□**” at the upper left of the display), the frequency can be changed by turning the **DIAL** knob only in the upper/lower limit frequency range stored by PMS memory.

● Disable the PMS function

1. Press the **[V/M]** key.
Return to the normal memory mode.

Memory Bank Scanning

Scan only the memory channels stored in the recalled memory bank.

1. Recall the memory bank you want to scan by referring to “Open the Memory Bank display” (page 18) and “Open Memory Bank Channels” (page 18).
2. Touch **[F MW]** → **[SCAN]**.
If **[SCAN]** is not displayed, touch **[BACK ←]** to display **[SCAN]** and then touch it.
Memory bank scan starts.

Memory Bank Link Scanning

During regular memory bank scanning, only the memory channels assigned to the recalled memory bank are scanned. During memory bank link scanning, you can scan memory channels registered in two or more banks you specified in advance.

Setting Bank Link

1. Press and hold the **[DISP]** key → touch **[MEMORY]** → **[1 BANK LINK]**.
2. Rotate the **DIAL** to select the memory bank for which you want to perform bank link scanning.
3. Press the **[DISP]** key, a check mark will appear and it will be set to Bank Link.
4. Repeat steps 3 and 4 to select other memory banks.
5. Press the **PTT** switch to save the setting and return to normal operation.

Performing Bank Link Scan

1. Recall the memory bank set as bank link by referring to “Open the Memory Bank display” (page 18) and “Open Memory Bank Channels” (page 18).
The memory bank number is changed from **[B]** to **[b]** and the bank link scanning is activated.
2. Touch **[F MW]** → **[SCAN]**.
If **[SCAN]** is not displayed, touch **[BACK ←]** to display **[SCAN]** and then touch it.
Bank Link Scanning is performed toward the higher memory channel numbers.



Press and hold the **[DISP]** key → touch **[SCAN]** → **[5 SCAN WIDTH]** → **[BANK LINK]** is set to “OFF”, to temporarily disable banklink and perform normal memory-bank scanning while banklink is set.

Dual Receive (D.RCV) Function

The transceiver is equipped with the following 3 types of Dual Receive Functions:

- VFO Dual Receive
- Memory Channel Dual Receive
- Home Channel Dual Receive

The transceiver checks for signals on the frequency registered to the selected memory channel (Priority Memory Channel) once approximately every 5 seconds. When receiving a signal on the frequency registered to a priority memory channel, the Dual Receive function automatically pauses, and allows reception of the signals.

Example: Checking the priority memory channel “100” (145.000 MHz), while receiving “432.500 MHz”.

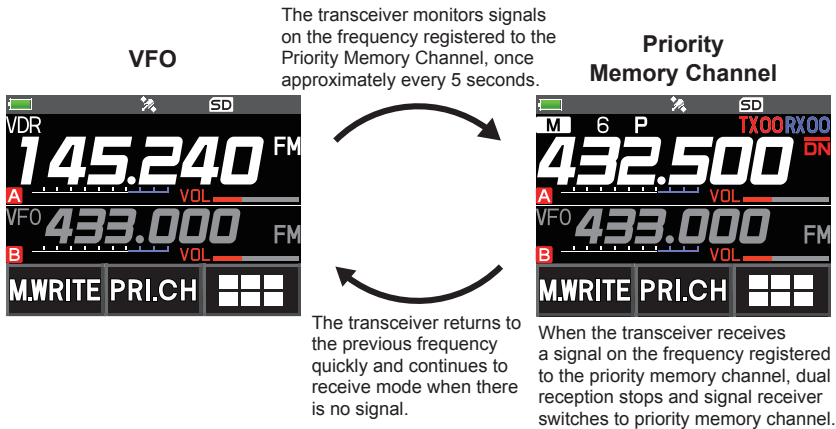

Registering the priority channel

1. Register the preferred receive frequency and communication mode to the priority memory channel (see the operating manual).
2. Press the [V/M] key to recall the memory channel.
3. Touch and hold [F MW], and then rotate the DIAL knob to select the memory channel registered in step 1.
4. Touch [PRI.CH].
 - The priority memory channel setting is saved and operation returns to the prior recalled memory channel.
 - When recalling the priority memory channel, the “P” icon appears on the upper right side of the memory channel number.

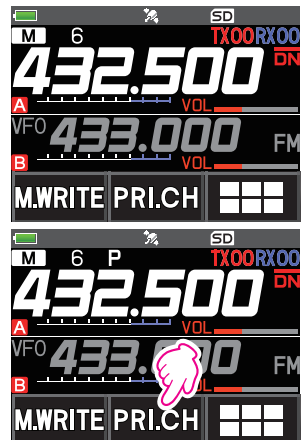

Activating the Dual Receive (D.RCV) feature

1. Set the frequency and communication mode to monitor continually.

The monitor frequency may be set on the VFO mode, the memory channel mode or the HOME channel mode.

VFO Dual Receive

VFO ⇄ Priority Memory Channel

Memory Channel Dual Receive

Memory Channel ⇄ Priority Memory Channel

HOME Channel Dual Receive

HOME channel ⇄ Priority Memory Channel

2. Touch **[F MW]** → **[D.RCV]**.

- If **[D.RCV]** is not displayed, touch **[BACK ←]** to display **[D.RCV]** and then touch it.
- The dual receive function is activated and the following icon is displayed on the top left of the display.

VFO Dual Receive:

VDR

Memory Channel Dual Receive: **MDR (/DXX/dXX)***

HOME Channel Dual Receive: **HDR**

* In the memory bank, **DXX** is displayed, and in the memory bank where the bank link is set, **dXX (XX** is a bank number) is displayed.

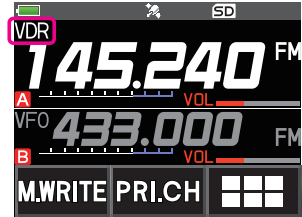

When a signal is received on the priority channel, the beep sounds, and the Dual Receive function stops temporarily.



The combination of the frequency bands and modes for the Priority Memory Channel and the receiver monitor frequency can be easily changed. Dual Receive may be operated with the AMS function ON.

Setting the Dual Receive (D.RCV) Resume Conditions

1. Press and hold the **[DISP]** → touch **[SCAN]** → **[4 SCAN RESUME]**.
2. Rotate the **DIAL** knob to select **"DW"**.
3. Press the **[DISP]** key, and then rotate the **DIAL** knob to select the resume condition after halting in the Dual Receive function (default setting is **"HOLD"**).

2.0 sec~10.0 sec

The signal is received for the specified period of time, and then the Dual Receive resumes.

The Dual Receive resume time may be set from 2 to 10 seconds at 0.5 second intervals.

BUSY

The signal is received until the signal fades out. Two seconds after the signal fades out, the Dual Receive resumes.

HOLD

The Dual Receive stops and tuning remains on the current receive frequency. (The Dual Receive does not resume.)

4. Press the **PTT** switch to save the new setting and return to normal operation.





Press and hold the **[DISP]** key → touch **[SCAN]** → **[6 PRIORITY REVERT]** is set to **"ON"**, press the **PTT** switch to transmit, without waiting for activity to appear on the priority channel. After transmitting, the transceiver receives the priority channel and Dual Receive resumes after 5 seconds.

AF-DUAL Receive Function

The AF-DUAL Receive Function allows reception of a radio broadcast during standby reception of A-band or B-band frequency (or frequency registered to a memory channel). When standby reception is active, no audio is heard on the standby frequency, however if a voice signal is detected, the reception of the broadcast radio will be paused, and the receiver frequency will be heard.

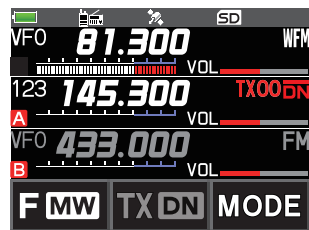
Dual Receive is a similar function. When using the Dual Receive function, every time the transceiver checks for a signal on the specified memory channel during radio reception, the radio reception is interrupted (approximately every 5 seconds). When using the AF-DUAL Receive Function, the radio reception is interrupted only when there is a calling signal from another transceiver.

1. Set the A-band or B-band frequency for standby receive during broadcast radio reception.
2. Touch **[F MW]** → **[A.DUAL]**.
 - If **[A.DUAL]** is not displayed, touch **[BACK ←]** to display **[A.DUAL]** and then touch it.
 - The AF-DUAL function is activated, and AF DUAL “The screenshot shows the radio's frequency display with three bands: VFO (81.300), A (145.300), and B (433.000). The A band is selected. The bottom of the screen shows buttons for 'F MW', 'TX DN', and 'MODE'. A small icon of a radio with a signal wave is visible in the top right corner of the display area.

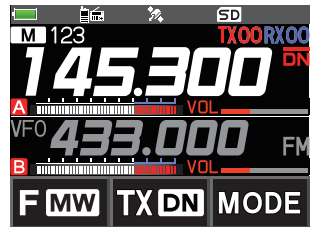

-
- The AF-DUAL receive function can also be used to monitor a radio frequency registered to a memory channel or memory bank.
 - Pressing **[MONI]** switch during radio reception, allows receiving the standby frequency.
 - While listening to the radio using the AF-DUAL function, in standby receive mode, the transceiver cannot simultaneously receive broadcasts on the AM frequency (middle wave band) on either the band-A or band-B, and FM frequency.



● Disable the AF DUAL function

1. Touch **[F MW]** → **[A.DUAL]**.

DTMF Operation

DTMF (Dual Tone Multi Frequencies) are the tone signals sent to make telephone calls, or control repeaters and network links. Up to 10 registers of 16-digit DTMF tone codes can be stored as telephone numbers to make calls through the public telephone network using a phone patch or connect through the WIRES-X analog node station.

Setting the DTMF Memory

1. Press and hold the **[DISP]** key → touch **[SIGNALING]** → **[5 DTMF MEMORY]**.
2. Rotate the **DIAL** knob to select the desired channel (1 to 10) to register the DTMF code, then press the **[DISP]** key.
The DTMF memory channel input screen is displayed.
3. Use the numeric keypad or **DIAL** knob to input the DTMF code maximum of 16 digits.
 - Using the **DIAL** knob:
The DTMF codes from 0 to 9 may be input.
••• ⇨ **0 to 9** ⇨ **A to D** ⇨ * ⇨ - ⇨ # ⇨ •••
4. Press the **PTT** switch to save the setting and return to normal operation.

Transmitting the Registered DTMF Code

1. Press and hold the **[DISP]** key → touch **[SIGNALING]** → **[4 DTMF MODE]**.
2. Rotate the **DIAL** knob to select the “**MODE**”.
3. Press the **[DISP]** key, and then turn the **DIAL** knob to select the setting.
AUTO ☎: The registered DTMF code is automatically transmitted.
MANUAL: The DTMF code may be transmitted manually by pressing each numeric key.
4. Press the **PTT** switch to save the setting and return to normal operation.
When set to “**AUTO**”, the DTMF icon “☎” will be shown on the display.

Transmitting DTMF code automatically using DTMF memory

1. Set “**AUTO** ☎” by referring to “Transmitting the Registered DTMF Code” (above).
2. While pressing and holding the **PTT** switch, touch **[DTMF]**.
3. Touch a numeric **[0]** to **[9]**.
 - The DTMF code registered in the DTMF memory channel is automatically transmitted.
 - Even after releasing the **PTT** switch, the transmission continues until the DTMF code is completed. The transceiver is automatically returned to receive mode.

Manually Transmitting the DTMF Code

1. Set “**MANUAL**” by referring to “Transmitting the Registered DTMF Code” (above).
2. While pressing and holding the **PTT** switch, touch **[DTMF]**.
 - Touch each corresponding key to send the DTMF code
 - The transmission may continue for one second after releasing the **PTT** switch.

Using the GPS Function

The GPS Function

GPS (Global Positioning System) is a space-based satellite navigation system that provides location and time information anywhere on the earth. It was developed by the U.S. Department of Defense as a military system. When the GPS receiver acquires 3 or more signals (of about 30) GPS satellites orbiting at an altitude of about 20,000 km, it can calculate and display its current position (latitude, longitude, and altitude) within a tolerance of several meters. In addition, GPS can receive the exact time from the satellite onboard atomic clock.

Activating the GPS Function

Activating the GPS function enables the transceiver to automatically obtain the internal clock setting, and your location information setting from the GPS data.



The default setting is ON.

1. Press and hold the **[DISP]** key → touch **[APRS]** → **[20 GPS POWER]**.
2. Rotate the **DIAL** knob to select **"GPS ON"**.
3. Press the **PTT** switch to save the setting and return to normal operation.



When the GPS function is active, the power consumption increases by about 18 mA. As a result, the battery life is reduced, as compared to when the GPS function is deactivated.

Displaying Position Information of Remote Stations in Digital Mode

With V/D mode of the C4FM digital, the GPS position information is transmitted simultaneously with voice signals; therefore, the direction and position of the remote station can be displayed in real-time even while communicating.

For details, see "Real-Time Navigation Function" (page 32)



- Even if the GPS function of your station is set to OFF, the position information of the remote station can be displayed in V/D mode.
- When the GPS function is not active, the remote station cannot display the position information for your station.

About Positioning by GPS

“Positioning” refers to calculation of your current position from the satellite orbit information and radio propagation time. At least 3 satellites need to be acquired for successful positioning. If positioning fails, move away from buildings as far as possible and stand in an area with open sky.

• About errors

The measurement environment may result in positioning errors of several hundred meters. Under favorable conditions, positioning can be performed successfully using only three satellites. However, under the following poor conditions, the positioning accuracy can decrease or positioning can fail.

- Between tall buildings
- Narrow paths between buildings
- Indoors or near large buildings
- Under elevated roads or high voltage power lines
- Between trees such as in forests or woods
- Inside a tunnel or underground
- Through heat reflective glass
- Areas with strong magnetic fields

• When not in use for a long time

When using the GPS functions for the first time after purchase, or when it has been unused in a while, a few minutes may be required to acquire the satellites. Also, if the GPS function has been turned OFF for several hours, a few minutes may be required to search for satellites.

Saving GPS Information (GPS Log Function)

The GPS position information can automatically be saved periodically onto a microSD memory card. Using the saved data, tracks can be displayed on commercially available map software*.

* Technical support for the map software is not provided by YAESU.

1. See “Activating the GPS Function” on page 28, and activate the GPS function.
2. Press and hold the [DISP] key → touch [CONFIG] → [7 GPS LOG].
3. Rotate the **DIAL** to select the GPS data logging interval.
OFF / 1 sec / 2 sec / 5 sec / 10 sec / 30 sec / 60 sec
4. Press the **PTT** switch to save the setting and return to normal operation.

The GPS log function is activated, and GPS log “LOG” icon will be displayed.



- The position information is saved periodically unless “OFF” is selected in step 3 (shown above) or the power of the transceiver is turned off.
- Reselecting the GPS data logging interval in step 3 or turning on the transceiver again, begins saving the GPS data under a different file name.

Checking Tracks on Your PC

1. Turn off the transceiver.
2. Remove the microSD memory card from the transceiver.
3. Connect the microSD memory card to your PC using a commercially available memory card reader.
4. Open the “FT3D” folder in the microSD memory card.
5. Open the “GPSLOG” folder.
 - The data is saved as “GPSyymmddhhmmss.log”.
 - The [yymmddhhmmss] part of the name consists of year (yy), month (mm), day (dd), hour (hh), minute (mm), and second (ss).



- Tracks can be displayed on the map by importing the data to commercially available map software.
 - For information on importing, please refer to the operation manual for the map software you use.
-

GPS Screen Information and Operation

Activating the GPS function displays the following information on the LCD.

1. In the normal operation screen, press the **[DISP]** key.

If the navigation screen is displayed, touch the compass display to switch to the GPS information screen.

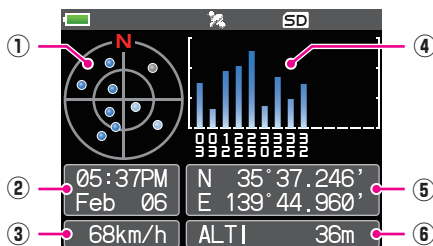

- ① Displays the satellite azimuth and elevation angles. Displays in North-up mode.
- ② Displays the date and time.
- ③ Displays the current speed.
- ④ Displays the satellite number and reception level.
- ⑤ Displays the latitude on the upper side of the screen whereas displays the longitude on the lower side of the screen.

The current position appears using north (N) or south (S) latitude.

Display format: X DD° MM. MMM

X: X=N: North latitude, X=S: South latitude, DD: Degree, MM:MMM Minute

Example: N 35° 37.250 (35 degrees, 37 minutes, 15 seconds north latitude)

The current position appears using east (E) or west (S) longitude.

Display format: X DDD° MM. DMMM

X: X=E: East longitude, X=W: West longitude, DDD: Degree, MM:MMM Minute

Example: E 139° 44.500 (139 degrees, 44 minutes, 30 seconds east latitude)

- ⑥ Displays the altitude of the current position “ALTI xxxm”.

Example: ALTI 36m

-
- The GPS data units for position, speed and altitude may be changed by pressing and holding the **[DISP]** key → touch **[APRS]** → **[22 GPS UNIT]**.
 - When the GPS function is used, the accurate time and date are obtained from GPS and shown on the LCD in 24-hour format. This time data is displayed on the GPS and APRS screens.
 - The geodetic system datum (WGS-84 / Tokyo) of the built-in GPS unit may be selected by pressing and holding the **[DISP]** key → touch **[APRS]** → **[19 GPS SETUP]** in Set mode. However, since APRS uses the geodetic system of WGS-84, it is recommended not to change it.
 - The time zone may be set at 30-minute increments by press and hold the **[DISP]** key → touch **[APRS]** → **[28 TIME ZONE]** (the default setting: UTC 0:00).
 - The position information obtained from an external GPS device may be used by pressing and holding the **[DISP]** key → touch **[APRS]** → **[17 COM PORT SETTING]** and then setting “**INPUT**” to “**GPS**”. In this case, the data from the internal GPS will be ignored.
 - When using an external GPS device, move it away from the transceiver to reduce interference.
-



Smart Navigation Function

There are 2 methods of navigation with the Smart Navigation function.

- Real-time navigation function
- Backtrack function

 Before using the smart navigation function, press and hold the [DISP] key → touch [APRS] → [1 TARGET LOCATION], select “COMPASS”.

Real-Time Navigation Function

GPS position information and voice signals are simultaneously transmitted in the V/D mode of C4FM digital. For this reason, the position and direction of the remote station can be displayed in real time even during communication.

1. In the normal operation screen, press the [DISP] key.
If the GPS information screen is displayed, touch the compass display to switch to the navigation display screen.
2. Touch [] to switch to the remote station location information display.
3. The distance and direction to the remote station operating on the same frequency in the V/D mode are displayed.

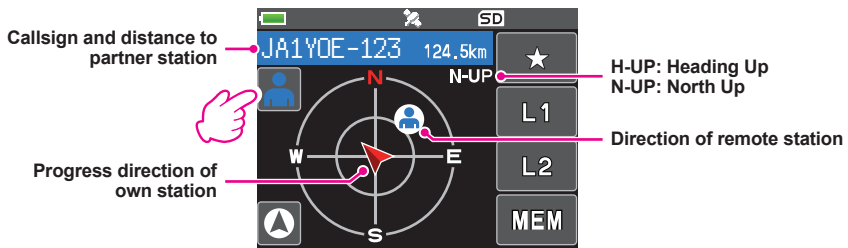

4. Press the [DISP] key to return to the normal operation display.

Backtrack Function

By registering a point such as the departure point in advance, the distance and direction to the registered point from your current position can be displayed in real time.

● Registering Your Current Position (Departure Point) (up to 3 Positions can Be Registered)

1. In the normal operation screen, press the **[DISP]** key.
If the GPS information screen is displayed, touch the compass display to switch to the navigation display screen.
2. Touch **[A]** to switch to your own station location information display.

 You can register the other partner's callsign and current location by touching **[P]** and performing the registration operation while the remote station's location information is displayed.

3. Touch **[MEM]**.
“★”, **L1** and **L2** blink.

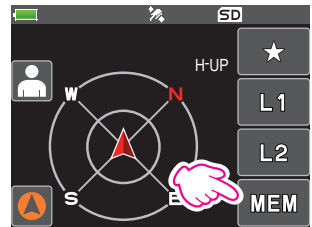

4. Touch one of the blinking indicators to which you want to register the position information.
 - The location information is registered with the selected indicator.
5. Press the **[DISP]** key return to normal operation display.

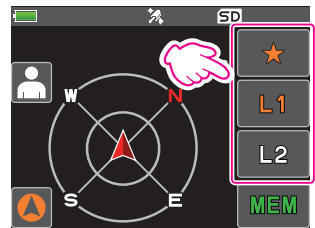

● Using the Back Track Function

1. In the normal operation screen, press the **[DISP]** key.
If the GPS information screen is displayed, touch the compass display to switch to the navigation display screen.
2. Touch the indicator (**[★]**, **[L1]** or **[L2]**) to which you want to register the location information for back tracking.
 - The arrows in the circle indicate the direction of the registered point (departure point). You can return to the departure point by moving forward so that the arrow always points up (In case of heading up display).
3. Press the **[DISP]** key to return to normal operation display.

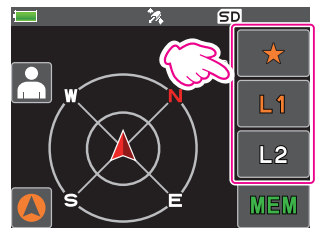

● Description of the BACK TRACK Function Screen

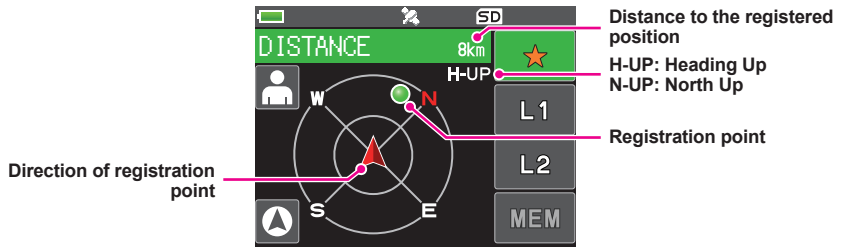

The folder configuration of the micro-SD card

A commercially available microSD memory card may be inserted into the FT3DR/DE to save various data files.

The data of each function is stored in the following folders.

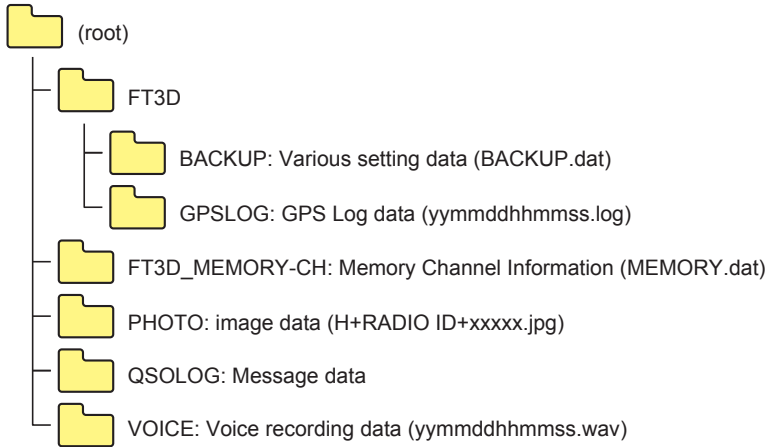

The [yymmddhhmmss] part of the file name consists of year (yy), month (mm), day (dd), hour (hh), minute (mm), and second (ss).

Preset receiver channel lists

The preset receiver function presets the frequencies and memory tags (names) of 156 channels and various radio stations into the following three categories:

- Weather Broadcast Stations (10 channels)
- International VHF Marine Radio (57 channels)
- International Worldwide Broadcast (89 channels)

Recall a preset receiver

1. Press the **[A/B]** key to set the A-band as the operating band.
2. Touch **[F MW]**, and then touch **[P.RCVR]**.
If **[P.RCVR]** is not displayed, touch **[BACK ←]** to display **[P.RCVR]** and then touch it.
3. Press the **[BAND]** key repeatedly, to select the desired preset receiver band.
••• → WX CH → INT VHF → SW → •••
4. Rotate the **DIAL** knob to select the desired channel or frequency.

● Return to normal mode

1. Press the **[BACK]** key or touch **[F MW]** and then touch **[P.RCVR]**.

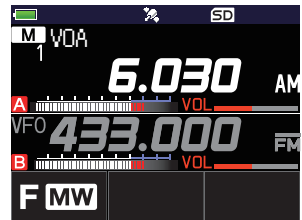

Weather Broadcast Stations (10 channels)



The frequencies (10 channels) used for the VHF Weather Broadcast Stations are registered.

Memory channel No.	Frequency (MHz)	Memory channel No.	Frequency (MHz)
1	162.550	6	162.500
2	162.400	7	162.525
3	162.475	8	161.650
4	162.425	9	161.775
5	162.450	10	163.275

International VHF Marine Radio (57 channels)

The frequencies used for international VHF (marine) radio are registered.

Memory channel No.	Frequency (MHz)		Memory channel No.	Frequency (MHz)	
1	156.050	160.650*	60	156.025	160.625*
2	156.100	160.700*	61	156.075	160.675*
3	156.150	160.750*	62	156.125	160.725*
4	156.200	160.800*	63	156.175	160.775*
5	156.250	160.850*	64	156.225	160.825*
6	156.300		65	156.275	160.875*
7	156.350	160.950*	66	156.325	160.925*
8	156.400		67	156.375	
9	156.450		68	156.425	
10	156.500		69	156.475	
11	156.550		70	156.525	
12	156.600		71	156.575	
13	156.650		72	156.625	
14	156.700		73	156.675	
15	156.750		74	156.725	
16	156.800		75	156.775	
17	156.850		76	156.825	
18	156.900	161.500*	77	156.875	
19	156.950	161.550*	78	156.925	161.525*
20	157.000	161.600*	79	156.975	161.575*
21	157.050	161.650*	80	157.025	161.625*
22	157.100	161.700*	81	157.075	161.675*
23	157.150	161.750*	82	157.125	161.725*
24	157.200	161.800*	83	157.175	161.775*
25	157.250	161.850*	84	157.225	161.825*
26	157.300	161.900*	85	157.275	161.875*
27	157.350	161.950*	86	157.325	161.925*
28	157.400	162.000*	87	157.375	
			88	157.425	

* indicates the frequency of the VHF marine base station. For example: if the preset receiver memory channel 1 is selected, the base station frequency 160.650 MHz appears and  lights up. Touching **[F MW]** followed by **[REV]** displays the Ship Station frequency 156.050 MHz appears and  blinks. The frequency lower than the base station frequency by 4.6 MHz is the Ship Station frequency and duplex operation may commence. To return to the base station frequency, press **[F MW]** followed by **[REV]**.

International World Wide Broadcast (89 channels)

The major shortwave broadcast stations around the world are registered.

CH Number	Frequency (MHz)	Name	Broadcast Station Name	CH Number	Frequency (MHz)	Name	Broadcast Station Name
1	6.030	VOA	USA	46	11.880	SPAIN	Spain
2	6.160	VOA	USA	47	11.910	SPAIN	Spain
3	9.760	VOA	USA	48	15.290	SPAIN	Spain
4	11.965	VOA	USA	49	6.055	NIKKEI	Japan (Nikkei)
5	9.555	CANADA	Canada	50	7.315	NORWAY	Norway
6	9.660	CANADA	Canada	51	9.590	NORWAY	Norway
7	11.715	CANADA	Canada	52	9.925	NORWAY	Norway
8	11.955	CANADA	Canada	53	9.985	NORWAY	Norway
9	6.195	BBC	UK	54	6.065	SWEDEN	Sweden
10	9.410	BBC	UK	55	9.490	SWEDEN	Sweden
11	12.095	BBC	UK	56	15.240	SWEDEN	Sweden
12	15.310	BBC	UK	57	17.505	SWEDEN	Sweden
13	6.090	FRANCE	France	58	6.120	FINLAND	Finland
14	9.790	FRANCE	France	59	9.560	FINLAND	Finland
15	11.670	FRANCE	France	60	11.755	FINLAND	Finland
16	15.195	FRANCE	France	61	15.400	FINLAND	Finland
17	6.000	DEUTSCHE WELLE	Germany	62	5.920	RUSSIA	Russia
18	6.075	DEUTSCHE WELLE	Germany	63	5.940	RUSSIA	Russia
19	9.650	DEUTSCHE WELLE	Germany	64	7.200	RUSSIA	Russia
20	9.735	DEUTSCHE WELLE	Germany	65	12.030	RUSSIA	Russia
21	5.990	ITALY	Italy	66	7.465	ISRAEL	Israel
22	9.575	ITALY	Italy	67	11.585	ISRAEL	Israel
23	9.675	ITALY	Italy	68	15.615	ISRAEL	Israel
24	17.780	ITALY	Italy	69	17.535	ISRAEL	Israel
25	7.170	TURKEY	Turkey	70	6.045	INDIA	India
26	7.270	TURKEY	Turkey	71	9.595	INDIA	India
27	9.560	TURKEY	Turkey	72	11.620	INDIA	India
28	11.690	TURKEY	Turkey	73	15.020	INDIA	India
29	9.660	VATICAN	Vatican	74	7.190	CHINA	China
30	11.625	VATICAN	Vatican	75	7.405	CHINA	China
31	11.830	VATICAN	Vatican	76	9.785	CHINA	China
32	15.235	VATICAN	Vatican	77	11.685	CHINA	China
33	5.955	NEDERLAND	Netherlands	78	6.135	KOREA	South Korea
34	6.020	NEDERLAND	Netherlands	79	7.275	KOREA	South Korea
35	9.895	NEDERLAND	Netherlands	80	9.570	KOREA	South Korea
36	11.655	NEDERLAND	Netherlands	81	13.670	KOREA	South Korea
37	5.985	CZECH LIBERTY	Czech Republic	82	6.165	JAPAN	Japan
38	6.105	CZECH LIBERTY	Czech Republic	83	7.200	JAPAN	Japan
39	9.455	CZECH PRAGUE	Czech Republic	84	9.750	JAPAN	Japan
40	11.860	CZECH LIBERTY	Czech Republic	85	11.860	JAPAN	Japan
41	9.780	PORTUGAL	Portugal	86	5.995	AUSTRALIA	Australia
42	11.630	PORTUGAL	Portugal	87	9.580	AUSTRALIA	Australia
43	15.550	PORTUGAL	Portugal	88	9.660	AUSTRALIA	Australia
44	21.655	PORTUGAL	Portugal	89	12.080	AUSTRALIA	Australia
45	9.650	SPAIN	Spain				

Receive Mode: AM

Caution

When the All Reset function is performed, all data registered in the memory will be deleted. Be sure to note the settings on paper or back up the data on a microSD memory card. For details on how to save backup onto a microSD memory card refer to "Set Mode: SD CARD Menu Operations" (page 84).

All Reset

To restore all transceiver settings and memory content to the factory defaults.

1. Turn the transceiver **OFF**.
2. Press and hold the **[BACK]** key, the **[DISP]** key and the **[BAND]** key and turn the transceiver **ON** simultaneously.
The beep sounds and the confirmation screen is displayed.
3. Touch **[OK]**.
 - The beep will sound, and the transceiver will reset all factory defaults.
 - After resetting all defaults, the call sign input message appears on the LCD. Set the call sign.
 - To cancel the resetting, touch **[CANCEL]**.

Set Mode Reset

Reset only the Set mode parameters, and restore them to the default settings.

1. Turn the transceiver **OFF**.
2. Press and hold the **[BACK]** key and the **[DISP]** key and turn the transceiver **ON** simultaneously.
The beep sounds and the confirmation screen is displayed.
3. Touch **[OK]**.
 - The beep will sound, and the transceiver will reset all Set mode settings to defaults.
 - To cancel the resetting, touch **[CANCEL]**.
 - To reset all the following items, perform All Reset (see above).

[DISPLAY]

7 OPENING MESSAGE

[TX/RX]

1-1 ANTENNA ATT
1-2 FM BANDWIDTH
1-3 RX MODE
2-4 DIGITAL VW

[MEMORY]

1 BANK LINK
2 BANK NAME
3 MEMORY NAME
5 MEMORY SKIP

[SIGNALING]

1 BELL
2 DCS CODE
3 DCS INVERSION
5 DTMF MEMORY
6 PAGER
7 PR FREQUENCY

9 SQL S-METER

11 SQL TYPE
12 TONE SQL FREQ

[SCAN]

5 SCAN WIDTH

[GM]

1 DP-ID LIST

[WIRES-X]

1 RPT/WIRES FREQ
2 SEARCH SETUP
3 EDIT CATEGORY TAG
4 REMOVE ROOM/NODE

[CONFIG]

6 CLOCK TYPE
12 PASSWORD
15 RPT SHIFT
16 RPT SHIFT FREQ
18 STEP

[APRS]

6 APRS MSG GROUP
7 APRS MSG TEXT
13 BEACON INFO
15 BEACON STATUS TEXT
17 COM PORT SETTING
18 DIGI PATH
19 GPS SETUP
23 CALLSIGN (APRS)
24 MY POSITION
25 MY SYMBOL

[OPTION]

2 Bluetooth
3 DEVICE LIST
25 Bluetooth Save

[CALLSIGN]

CALLSIGN

Functions to Use as Necessary

Using the Transceiver for Packet Communication

You can perform packet communication with your transceiver by connecting a TNC (Terminal Node Controller) using an optional Microphone Adapter (CT-44).

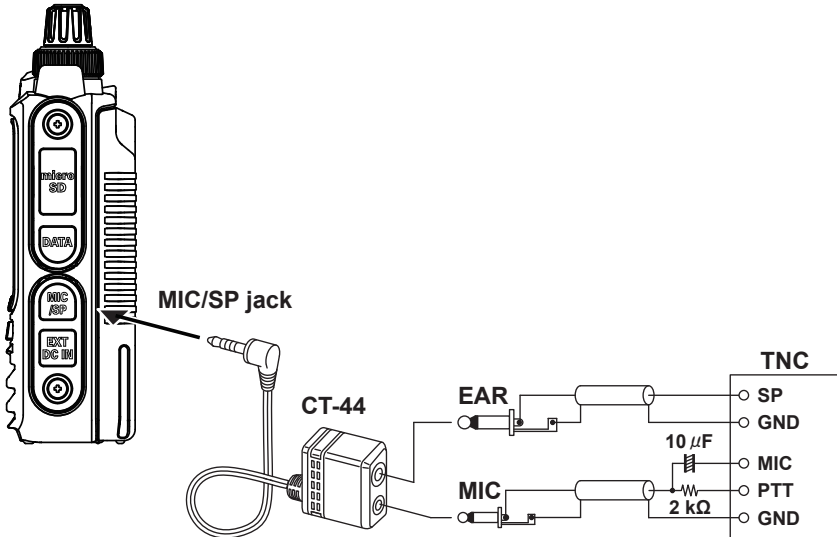

After connecting the TNC to the transceiver, set the output signal level to the TNC by adjusting the sound volume level of the transceiver.

Also, adjust the signal level input to your transceiver using the output level adjustment volume on the TNC (Input level cannot be adjusted on your transceiver).



When sending a vast volume of data, the transmission takes a longer time and the transceiver may be overheated. If the transmission is continued for a long time, the overheat prevention circuit will operate and the transmission power decreases. If the transmission is continued further, the transmission will be automatically stopped to prevent the transceiver from overheating and consequently malfunctioning. If the overheat prevention circuit has operated the transceiver returns to the receive mode, turn the transceiver OFF, or leave it in the receive mode until the temperature falls.



- Set the receive battery Save Function to OFF during packet communication by pressing and holding the [DISP] key → touch [CONFIG] → [17 SAVE RX].
- Reception can be interfered with by noise generated by the Personal Computer.
- If the transceiver enters an abnormal receive state, disconnect the transceiver from the PC, and reconnect it to the PC using a photo coupler device or noise filter.
- For details on how to connect a TNC to the PC, refer to the TNC instruction manual.

Clone Operation

Data and various settings saved in your transceiver can be copied to any other FT3DR/DE transceiver.

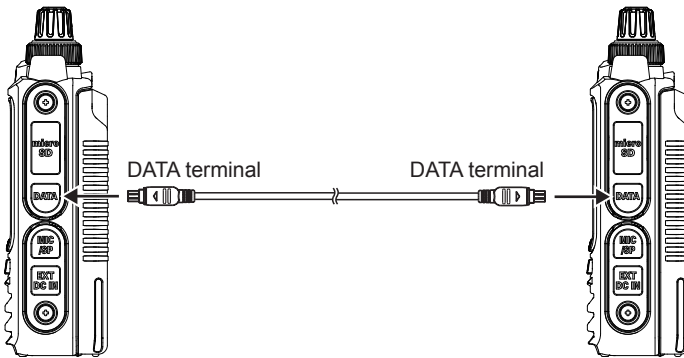

1. Turn OFF the power of both FT3DR/DE transceivers, then connect an optional clone cable (CT-168) to the DATA terminal of each transceiver.
 2. While pressing and holding the [**DISP**] keys on both FT3DR/DE transceivers, press the POWER switch.
The two transceivers are turned on and placed in the clone mode. The “**CLONE**” appears on the display.
 3. Touch [**RECEIVE**] on the receiving side transceiver.
The “**WAIT**” appears on the display.
 4. Touch [**SEND**] on the transmitting side transceiver.
 - The “**TX**” appears on the display and data transfer starts.
 - When data transfer starts, the display on the receiving transceiver changes from “**WAIT**” to “**RX**”.
 - When data transfer begins, the data transfer amount indicator appears on the LCD.
 5. When copying is completed, the receiving side transceiver returns to the normal mode. On the transmission side transceiver, the indication on the LCD returns from “**TX**” to “**CLONE**”.
 6. Turn OFF the power of both transceivers, then disconnect the clone cable.
-
- i**
- When the “**ERROR**” appears on the LCD during data transfer, copying cannot be completed. Check the clone cable connection, and redo the operation from the beginning.
 - Time data cannot be copied.
-

Connecting to a PC

Updating the FT3DR/DE firmware

To update the transceiver firmware, connect a PC to the DATA terminal of the FT3DR/DE with the supplied USB cable, as described below:

When a new firmware update for the FT3DR/DE is available, download the data from the YAESU website to update the FT3DR/DE to the latest version.

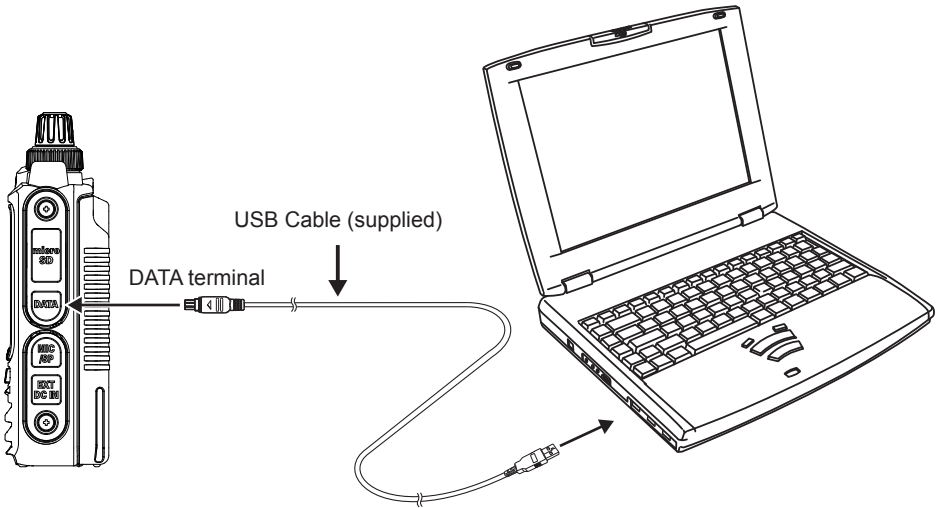

In case of a malfunction

Check the following items before requesting a repair.

● The transceiver does not turn ON.

- Is the battery depleted?
 - Charge the battery pack after purchase, and when the transceiver has not been used for a long time.
- Is the battery pack properly attached?
 - Refer to “Installing the Battery Pack” and securely mount the battery pack.
- Is the external power supply properly connected?
 - When using an external power supply, connect the external power supply adapter with a cigarette lighter plug (SDD-13) or an external power cable (E-DC-6) to DC input jack.
- Is the voltage of the battery pack or the SDD-13 correct?
 - Be sure that there is a charge left in the battery pack (do not completely discharge). Check that the output voltage of the SDD-13 is approximately 12V.

● There is no sound.

- Is the level of squelch (or S meter squelch) set too high?
 - Press the Monitor Switch and verify that white noise can be heard.
 - Adjust the level of squelch (or S meter squelch) when receiving a weak signal.
- Is the volume low?
 - Rotate the VOL knob clockwise to increase the volume.
- Is the tone squelch or DCS on?
 - When the tone squelch or DCS is on, the sound is not output until the transceiver receives a signal containing the same tone frequency or DCS code set.
- Is the C4FM digital mode on?
 - When the AMS function is on, the sound is not output until the transceiver receives a signal containing the Analog FM mode.
 - Also, when the DG-ID function is on and set the DG-ID number to except for “00”, the sound is not output until the transceiver receives a signal correspond to the DG-ID number.

● There is no transmission of radio waves.

- Are you pressing the **PTT** switch properly?
- Is the **PTT** lock on?
- Is the Busy TX Block (BCLO function) on?
 - When the Busy TX Block (BCLO function) is on, transmission cannot be done when receiving a signal even if **PTT** is pressed. Wait until signal being received stops and then press **PTT**.
- Is the transmission frequency on a ham radio band?
 - Transmission cannot be performed on the AM Radio Broadcast Band, the Short-Wave Radio Band, the FM Radio Broadcast Band, the Air Band, or the Information Radio Band.
- Is the voltage of the battery pack or external power source correct?
 - Check the remaining charge on the battery pack.
 - In addition, using an inadequate power supply where voltage drops during transmission will prevent the FT3DR/DE from operating at full capability.

● The keys or DIAL do not respond.

- Is the Key Lock or DIAL Lock on?

● The battery pack cannot be charged, or the battery power depletes immediately after charging.

- Is the battery pack being charged with a charger specified by Yaesu?
 - Charge the battery pack using the accessory battery charger (SAD-25) or the rapid charge cradle (CD-41). When using an external power supply, use the external power supply adapter with a cigarette lighter plug (SDD-13) or an external power cable (E-DC-6).
 - When charging with an external power supply, charge in the input voltage range of 10.5 to 16 VDC with the EXT DC IN terminal.
- Is the battery pack in use exhausted?
- If the “Charging Error” appears on the LCD when charging, there is a chance the battery pack is over discharged. If the error is repetitively displayed after charging the battery pack several times, the battery pack may have reached its service life or be defective. Battery packs are consumables. Please replace the battery pack with a new one immediately. Battery packs can be charged and reused up to approximately 300 times.



Copyright 2019
YAESU MUSEN CO., LTD.
All rights reserved.

No portion of this manual may be
reproduced without the permission of
YAESU MUSEN CO., LTD.

YAESU MUSEN CO., LTD.

Tennozu Parkside Building
2-5-8 Higashi-Shinagawa, Shinagawa-ku, Tokyo 140-0002 Japan

YAESU USA

6125 Phyllis Drive, Cypress, CA 90630, U.S.A.

YAESU UK

Unit 12, Sun Valley Business Park, Winnall Close
Winchester, Hampshire, SO23 0LB, U.K.