

YAESU

The radio

FT1DRIDE

Operating Manual

144/430MHz
DIGITAL/ANALOG
TRANSCEIVER

C4FM FDMA



Read this information first

Basic Operation

Repeater Operation

Using the Memory

Scanning Function

Using the Digital GM Function

Using the APRS Function

Using the GPS Function

Convenient Functions

Communicating with a
Specific Remote Station

Functions Used As Needed

Appendix

Table of Contents

Read this information first	2	Repeater Operation	40
Introduction.....	5	Repeater Shift.....	41
How to Read This Manual.....	6	Automatic Repeater Shift (ARS).....	41
Checking Bundled Items.....	6	A Wide Variety of Memory Functions.....	42
Safety Precautions (Be Sure to Read).....	7	Using the Memory	42
Before Transmitting Radio Waves.....	11	Registering to Memory Channel.....	43
Names and Functions of Controls.....	12	Split Memory.....	44
Preparation.....	15	Recalling a Memory Channel.....	44
Installing the Antenna.....	15	Recalling Home Channel.....	45
Attaching the Accessory Belt Clip/Protective Cap.....	15	Returning to the Previous Frequency.....	45
Attaching the Protective Cap.....	15	Deleting Memory Channel.....	46
Attaching the Belt Clip.....	15	Restoring Deleted Memory Channel.....	46
Basic Operation	15	Using Memory Tag.....	46
Attaching a Hand Strap.....	16	Assigning a Name to a Memory Channel.....	47
How to Use the Battery Case (FBA-39) Optional...	16	Displaying Memory Tag.....	47
Installing/Removing the Battery Pack.....	17	Using Memory Bank.....	48
Installing the Battery Pack.....	17	Registering a Memory Channel in a Memory Bank...	48
Removing the Battery Pack.....	17	Recalling Memory Bank.....	49
Charging the Battery Pack.....	17	Canceling Memory Channel Registration in	
Connecting an External Power Supply		Memory Bank.....	49
for Use in Vehicle (USA/EXP version only)...	20	Assigning Name to Memory Bank.....	49
Connecting to an External Power Supply		Convenient Preset Receiver Memory Channels.....	51
Using a Power Cable (USA/EXP version only)...	20	Registering Your Favorite Preset Receiver	
Using a microSD memory card.....	22	Memory Channels in Memory Bank...	51
Usable microSD memory cards.....	22	Recalling Preset Receiver Memory Channel to	
Cautions when using a micro SD memory card...	22	Listen to the Weather Broadcast...	51
Mounting and dismantling microSD memory card...	22	Recalling Preset Receiver Memory Channel to	
Formatting a microSD memory card.....	24	Listen to the International VHF (Marine) Radio...	52
Performing Communication.....	25	Recalling Preset Receiver Memory Channel to	
Turning on the Transceiver.....	25	Listen to the World Broadcast...	54
Adjusting the Volume Level.....	26	Worldwide short wave broadcast.....	54
Selecting an Operating Band.....	27	Using the Scanning Function.....	56
Selecting a Frequency Band.....	29	VFO Scan.....	56
Tuning in to a Frequency.....	30	Scanning Function	56
Selecting Communication Mode.....	30	Canceling Scanning.....	57
Performing Communication.....	31	Skipping a Frequency You Do Not Want to	
Selecting Communication Mode.....	32	Scan (Skip Search Memory) ...	57
Listening to the Radio.....	33	Specifying the Frequency You Do Not	
Listening to the AM/FM Radio.....	33	Want to Scan...	58
Switching between AM Antennas.....	33	Deleting a Frequency Registered to the	
Miscellaneous Settings.....	34	Skip Search Memory Channel ...	58
Setting clock time.....	34	Selecting a Reception Method	
Setting the Time Signal.....	34	When Scanning Stops...	59
Muting Audio.....	35	Memory Channel Scanning.....	59
Changing the Transmission Power Level.....	36	Specifying a Skip/Selected Memory Channel...	60
Adjusting the Squelch Level.....	37	Scanning Only the Selected Memory Channel ...	61
Changing the Frequency Step Manually.....	37	Scanning a Memory Bank.....	61
Changing the Mode Manually.....	38	Memory Bank Link Scan.....	62
Locking keys and switches.....	39	Programmable Memory Channel Scan (PMS).....	63
Restoring to Defaults (All Reset).....	39	Registering to a Programmable	
Repeater Operation.....	40	Memory Channel...	63
Communicating Via the Repeater.....	40	Performing Programmable	
Tone Calling (1750 Hz).....	40	Memory Channel Scan...	64

Using the Digital GM Function
(Digital Group Monitor Function)..... 65
 What is the GM function? 65
 Standard Operation of the GM Function..... 65
 Using the GM Function 65

Using the APRS Function 67
 What is the APRS
 (Automatic Packet Reporting System)?... 67

Using the GPS Function 68
 What is GPS? 68
 Activating the GPS Function..... 68
 Method of Positioning by GPS..... 69
 Displaying Current Position Information
 of Your Station... 69
 Displaying Position Information of
 Remote Station in Digital Mode ... 69
 Saving GPS Information (GPS Log Function)..... 71
 Checking Tracks on a PC 71
 Explanation of GPS Screen and Operation 72
 Smart Navigation Function 73
 Using the Smart Navigation Function 73
 Description of the BACK TRACK Function Screen... 74
 Dual Reception (DW) Function 75
 VFO Dual Reception
 VFO mode → Priority memory channel ... 75



Convenient Functions..... 75
 Memory Channel Dual Reception
 Memory channel → Priority memory channel ...76
 Home Channel Dual Reception
 Home channel → Priority memory channel ...76
 AF-DUAL Function for simultaneous signal
 reception over the other frequency
 while listening to the radio... 77
 Using the DTMF Function..... 79
 Confirming the entered DTMF code
 by the sound... 80
 Sending the Registered DTMF Code..... 80
 Sending a DTMF Code Manually..... 81
 Searching for signals with the signal strength
 graph. Band Scope Function... 82
 Taking picture with the optional camera
 mounted on speaker microphone... 82
 Using the Tone Squelch Function..... 84

Communicating with a Specific Remote Station... 84
 Selecting a Tone Frequency..... 85
 Searching for the Frequency of the
 Tone Squelch Used by the Remote Station 86
 Selecting a DCS Code 86
 Searching for the Frequency of the
 DCS Used by the Remote Station... 87
 Notification of Call from the Remote
 Station by Vibration of the Vibrator ... 88
 Selecting Vibrator Operation Mode 88

Notification of a Call from a Remote Station
 by the Bell ... 89
 Changing the Number of Times the Bell Rings ... 89
 Calling Only a Specific Station
 New Pager Function ... 90
 Flow of Operation to Use the Pager Function ... 90
 Setting the Code of Your Station 91
 Turning on the New Pager Function..... 91
 Calling a Specific Station 92
 Being Called by the Remote Station
 (Standby Operation) ... 93
 Set Mode 94
 Using the Set Mode 94
 Resetting the Set Mode Options 94

Functions Used As Needed 94
 Set Mode Option List 95
 Displaying the GPS screen 103
 Setting the display method of the
 remote station information ... 104
 Setting the display method for BACKTRACK 104
 Setting the search channels for the
 BAND SCOPE function... 105
 Changing the Lighting Condition..... 105
 Selecting a Display Language 106
 Adjusting the LCD Contrast Level..... 106
 Adjusting the LCD Backlight and
 Keypad Key Light Brightness Level... 107
 Changing the Opening Message Displayed
 Immediately after Power-on... 107
 Measuring the Battery Voltage and the
 Transceiver Temperature Power Supply
 Voltage Measurement Function/Temperature
 Measurement Function ... 108
 Changing the Display Pattern of the PO Meter ... 109
 Switching between AM Antennas..... 109
 Reducing receiver sensitivity Attenuator
 (ATT) Function ... 109
 Setting the transmission modulation level..... 110
 Changing the mode manually 111
 Switching between digital and analog mode..... 111
 Setting the AMS transmission mode..... 112
 Setting the squelch type for the digital mode..... 113
 Setting the pop up time of the
 remote station information ... 113
 Setting the Standby Beep 114
 Displaying the version of the DSP program 115
 Adjusting the microphone sensitivity
 Microphone Gain... 115
 Muting Voice 116
 Simultaneously radio broadcast reception 116
 Changing the sound volume setting method 116
 Setting memory bank link..... 117
 Assigning a name to a memory bank..... 117
 Assigning a name to a memory channel..... 117
 Prohibiting registration to memory channel
 Memory Channel Protect Function 118

Table of Contents

Setting memory skip function.....	118
Registering to a memory channel with the lowest memory channel number Memory Channel Write Function ...	118
Notifying a call from a remote station by the bell ...	119
Selecting a DCS code.....	119
Transmit and receive a DCS Code with a inverted phase DCS INVERSION Function ...	119
Setting the transmission method of the DTMF code...	120
Setting DTMF code.....	120
Calling only a specific station New Pager Function ...	120
Enabling no-communication squelch function PR FREQUENCY Function...	120
Adjusting the squelch level SQL LEVEL Function ...	121
Setting the signal strength to output sound S Meter Squelch Function...	121
Setting the squelch type for transmission and reception SQL EXPANTION FUNCTION ...	122
Setting the type of tone squelch	123
Selecting a tone frequency	123
Setting the sound and speed during tone search Tone Search Function ...	123
ON/OFF for the Weather Alert Feature.....	124
Setting the surveillance interval time for priority channels DW TIME Function ...	124
Turning illumination off when scanning stops SCAN LAMP Function...	125
Setting the time to resume scan SCAN RE-START Function...	125
Selecting a reception method when scanning stops...	126
Setting the range for SCAN	126
Turning off the power automatically APO Function...	127
Preventing accidental transmission Busy Channel Lockout (BCLO) Function...	128
Muting the key operation confirmation tone	128
Turning off the BUSY Indicator	129
Setting the clock shift for the micro computer Clock Type Function ...	129
Setting interval to save GPS position information ...	130
Permitting Transfer of Home Channel Frequency to VFO ...	130
Using the White LED as a Flashlight	131
Setting the conditions for locking LOCK Function ...	131
Setting the operation of 	132
Turning on/off the transceiver at the specified time Timer Function ...	132
Password Function	133
Setting the PTT delay time PTT DELAY Function...	134
Setting the ARS function RPT ARS Function.....	134
Setting the direction for repeater shift RPT SHIFT Function...	135
Setting the range for repeater shift RPT SHIFT FREQ Function...	135
Disabling reception while no signal is received Reception Save Function...	136
Changing the frequency step manually	136
Setting clock time.....	136
Restricting the continuous transmission time TOT Function ...	136
Setting the frequency selection range for operation in the VFO mode VFO MODE Function ...	137
Notification of a call from a remote station by vibration...	138
Saving/ Loading data to/from microSD memory card ...	138
Saving/ Loading memory channel information to/from microSD memory card ...	138
Saving/ Loading GROUP ID information to/from microSD memory card ...	139
Formatting a microSD memory card.....	140
Setting the optional microphone with camera for use ...	140
Registering CALLSIGN	141
Using the transceiver for packet communication ...	142
Clone Operation.....	143
Connecting an external device.....	144
Connecting to a PC	144
Connecting the FT1DR/DE to external devices ...	145
Data Cable (CT-170)	145
Data Cable (2.5Φ) (CT-176).....	145
Optional Parts.....	146
Appendix	146
If you suspect malfunction Check the following items before requesting for repair... 147	
The transceiver does not turn on.	147
There is no sound	147
There is no transmission of radio waves.....	147
The keys or  does not respond.	147
The battery pack cannot be charged or battery power depletes immediately after charging... 148	
Index.....	149
Specifications	152

Introduction

Features of the FT1DR/DE

○ Digital communication (C4FM (Quaternary FSK), FDMA system).....	31
○ Equipped with AMS (Automatic Mode Select) Function.....	32
Automatically selects between 4 modes of transmission to fit the signal being received.	
○ External power supply connection	20
○ Simultaneous reception on two different bands, or within the same band (V+V/U+U)	28
○ Independent switching keys for A-band and B-band and TX/BUSY display	28
○ Wide-band reception over the range of 500 kHz to 999.900MHz	28
○ Waterproof design conforming to IPX5 equivalent, which protects the transceiver from rain and splashes.....	11
○ Individual side keys, full keyboard for easy character entry, tilted main dials	12
○ Easy-to-see dot matrix display	14
○ WIRES-X connection support	See WIRES-X instruction manual*
○ Equipped with GM function	See GM function instruction manual*
○ Large-capacity 1266ch memory, with twenty-four 100ch memory banks	42
○ Display memory tags comprised of up to 16 one-byte characters	46
○ Convenient reception of preset receiver memory channels.....	51
By selecting preset frequencies, you can receive shortwave broadcast, and international VHF radio stations with ease.	
○ A wide variety of scan functions	56
○ Built-in GPS unit allowing display of your current location and heading information	68
○ Ready for APRS® communication using the world standard 1200/ 9600bps AX25 modem (B band only).....	See APRS instruction manual.*
○ High-resolution band scope function to display ± 50 channels	82
○ A variety of individual selective calling functions; such as tone squelch (CTCSS) and DCS functions	84
○ Vibrator to alert you of signal reception, in addition to the audible bell.....	88
○ New pager function for calling only specific stations.....	90
○ Illumination by white LED for easy viewing of the LCD outdoors.....	131
○ Built-in temperature sensor.....	108
○ Battery save function to prolong the operating time of the battery.....	136
○ Data terminal for communication with external equipment or firmware update	144
○ Built-in bar antenna for AM reception.....	33
○ Micro SD memory card slot.....	22
○ Snapshot function (an optional camera microphone MH-85A11U is required).....	82





* WIRES-X, GM function and APRS instruction manuals are not included in the product package. They are available and may be downloaded from the Yaesu.com website.



How to Read This Manual

Typical explanatory expressions used in this manual are as follows:

For pressing the  key short Press .

For pressing the  key long Press and hold  for over 1 second.

For pressing  →  Press  and then .

For pressing or turning  while pressing the  key..... Turn  while pressing .

Caution



...Explains caution to observe during operation.

Tip



...Explains operating suggestions or useful tips.

Checking Bundled Items

FT1DR/DE

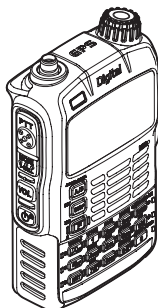

Antenna

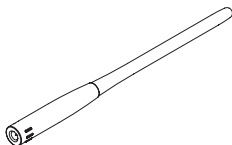

Lithium-ion battery pack
(FNB-102LI: 7.4 V,
1,800 mAh)

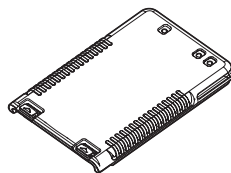

Battery charger

PA-48B/C/U* or SAD-11B

* "B" suffix is for use with 120 VAC (Type-A plug), "C" suffix is for use with 230-240 VAC (Type-C plug), and "U" suffix is for use with 230 VAC (Type-BF plug).

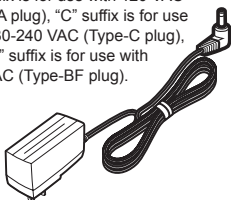

Belt clip

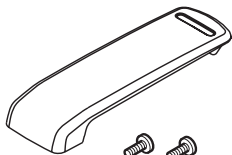

PC connection cable
(SCU-18 or SCU-19)

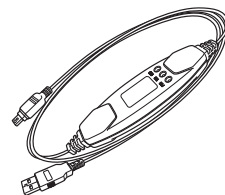

Card clip

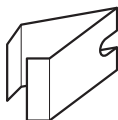

Protective plate for battery pack



- Quick Manual
- Warranty Card
- Instruction Manual (this manual)

Cautions

- Check that the name of the shop dealer from which you purchased the product and the date of purchase are indicated on the warranty card.
- If any item is missing, contact the shop dealer from which you purchased the product.

Safety Precautions (Be Sure to Read)

Be sure to read the safety precautions to use this product safely.

We are not liable for failures and other problems caused due to misuse or use of this product by you or a third party as well as the damages caused through use of this product by you or a third party except in the case where we are ordered to pay for damages under the laws.

Types and Meanings of Symbols



DANGER

Indicates an imminently hazardous situation which, if not avoided, could result in death or serious injury.



WARNING

Indicates a potentially hazardous situation which, if not avoided, could result in death or serious injury.



CAUTION

Indicates a potentially hazardous situation which, if not avoided, may result in minor or moderate injury or only property damage.

Types and Meanings of Legends



Indicates a prohibited action, not to be done in order to use this product safely. For example,  indicates that the product should not be disassembled.



Indicates a required action, to be done in order to use this product safely. For example,  indicates that the power plug should be removed.

||||| **DANGER** |||||



Do not use this product in “an area where use of it is prohibited”, e.g., inside the hospital, airplane, or train.”

This product can affect electronic or medical devices.



Do not use this product while riding a bicycle or driving a car. Accidents can result.

Be sure to stop the bicycle or car at a safe place before using this product.



Those who are carrying a medical device such as a cardiac pacemaker should not perform transmission near the device. When transmitting, use an external antenna and keep as far as possible away from the external antenna.

The radio wave emitted by the transmitter can cause the medical device to malfunction and result in an accident.



Do not use this product or the battery charger in a place where inflammable gas is generated.

A fire or explosion can occur.

Safety Precautions (Be Sure to Read)



Do not perform transmission in a crowded place for the safety of persons using a medical device such as a cardiac pacemaker.

The radio wave emitted from this product can cause the medical device to malfunction and result in an accident.



Do not touch any material leaking from the battery pack with bare hands.

The chemical that has stuck to your skin or entered your eye can cause chemical burns. In such a case, consult the doctor immediately.



Do not solder or short-circuit the terminal of the battery pack.

A fire, leak, overheating, explosion, or ignition can result.

Do not carry the battery pack together with a necklace, hair pin, or small metal objects. A short circuit can result.



If it starts thundering when the external antenna is used, immediately turn off this product and disconnect the external antenna from it.

A fire, electrical shock, or damage may result.



WARNING



Do not power this transceiver with a voltage other than the specified power supply voltage.

A fire, electric shock, or damage may result.



Do not use the battery pack for any model other than the specified transceiver.

A fire, leak, overheating, explosion, or ignition can result.



This product has a waterproof structure and conforms to "IPX5" when the included antenna and battery pack are installed and rubber caps are securely attached to the MIC/SP jack, EXTDC IN jack, DATA terminal, and micro SD slot. If this transceiver gets wet, wipe it with a dry cloth, etc. do not leave it exposed to the moisture.

Leaving this product in a wet condition can degrade its performance, shorten its life, or cause a failure or electrical shock.



Do not make very long transmissions.

The main body of the transceiver may overheat, resulting in a failure or burns.



Do not disassemble or make any alteration to this product.

An injury, electric shock, or failure can result.



Do not handle the battery pack or charger with wet hands. Do not insert or remove the power plug with wet hands.

An injury, leak, fire, or failure can result.



If smoke or strange odor is emitted from the main body, battery pack, or battery charger, immediately turn the transceiver off; remove the battery pack, and remove the power plug from the outlet.

A fire, leak, overheating, damage, ignition, or failure can result. Contact the dealer from which you purchased this product or Yaesu Amateur Customer Support.



Do not use the battery pack which is externally damaged or deformed.

A fire, leak, heating, explosion, or ignition can result.



Do not use any battery charger which is not specified by Yaesu.

A fire or failure can result.

Safety Precautions (Be Sure to Read)

Keep the terminals of the battery pack clean.



If terminal contacts are dirty or corroded, a fire, leak, overheating, explosion, or ignition can result.

If charging of the battery pack cannot be completed within the specified charging time, immediately remove the power plug of the battery charger from the outlet.



A fire, leak, overheating, explosion, or ignition can result.



CAUTION

Do not dangle or throw this product by holding its antenna.



This product can hit and injure someone. In addition, doing so can result in a transceiver failure or damage.

Do not use transceiver in a crowded place.



The antenna can hit someone, resulting in an injury.

Do not place this transceiver in a place subject to direct sunlight or near a heater.



The transceiver can deform or discolor.

Do not place this transceiver in a humid or dusty place.



A fire or failure can result.

During transmission, keep the antenna as far from you as possible.



Long-time exposure to electromagnetic waves can have a negative impact on your health.

Do not clean the case with thinner or benzene.



Use a soft, dry cloth to clean the case.

If you do not use this transceiver for a long period, turn it off and remove the battery pack for safety.



Do not drop, strike, or throw the transceiver.



A failure or damage may result.

Keep magnetic cards and video tape away from the transceiver.



The data recorded on cash cards or video tape can be erased.

Do not use the earpiece microphone, earphones, or headphones at an extremely high volume level.



Hearing impairment can result.

Keep this product out of reach of children.



An injury, etc. can result.

Install the hand strap and belt clip securely.



If they are installed improperly, the FT-1DR/DE may fall or drop, resulting in an injury or damage.

Do not place a heavy object on the power cord of the battery charger.



The battery cord can be damaged, resulting in a fire or electric shock.

Do not use the included battery charger to charge any battery pack which is not specified for use with the charger.



A fire can result.

Do not operate the transmitter near the TV or radio.



Radio disturbance can occur in the transceiver, the TV, or the radio.

Do not use any products other than the specified options and accessories.



A failure can result.

When the battery charger is not in use, remove its power plug from the outlet



Safety Precautions (Be Sure to Read)

Charge the battery pack within the temperature range from +5 °C to +35 °C (+41 °F to +95 °F).



Charging the battery pack outside this temperature range can cause leak, overheating, decrease in performance, or reduction in service life can result.

When unplugging the power cord of the battery charger, be sure to hold the power plug.



Pulling the power cord can damage it and cause a fire or electronic shock.



Before discarding the worn battery pack, affix tape or the like to its terminals.

Before using this transceiver in a hybrid or fuel-saving car, be sure to check with the automobile manufacturer regarding use of the transceiver in that car.



Noise generated by an onboard electrical device (inverter, etc.) can disrupt the normal operation of the transceiver.

About Waterproofing Feature Conforming to IPX5

When the included antenna and battery pack are installed and the MIC/SP jack, EXT DC IN jack, DATA terminal, and micro SD slot are securely covered with rubber caps, this product is moisture and splash resistant. To ensure continued waterproofing protection, be sure to check the following points before use.

- **Check for damages, deterioration, and dirt.**
Antenna rubber, key switch rubber, MIC/SP jack, EXT DC IN jack, DATA terminal, micro SD slot rubber cap, and battery pack joint.
- **Cleaning**
When this product is contaminated with seawater, sand, or dirt, rinse with fresh water, and then wipe with a dry cloth immediately.
- **Recommended maintenance interval**
It is recommended that you ask for maintenance of this product when one year has passed since purchase or previous maintenance or when any damage or deterioration is found. Note that the maintenance service is subject to fees.
- **Do not immerse this product in the following liquids:**
Sea, pool, hot spring, water containing soap, detergent, or bath additive, alcohol, or chemicals
- **Do not leave this product for a long time in the following places:**
Bathroom, kitchen, or humid place
- **Other precautions**
Since this product is not totally waterproof, it cannot be used in water.

Before Transmitting Radio Waves

If you are informed that the radio waves emitted from your amateur station are interfering with the TV, radio reception, etc., of a neighbor, you should stop emitting the radio waves, and determine whether any problem of interference exists, and if necessary resolve the interference problem.

Names and Functions of Controls

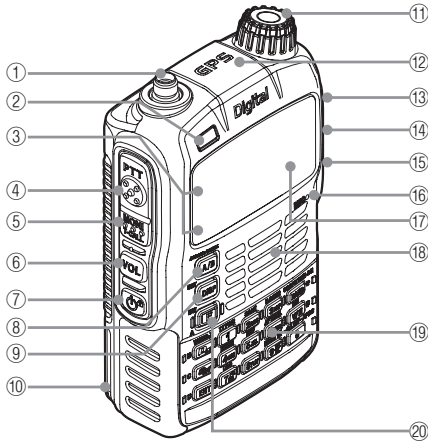

















①	Antenna terminal (SMA)*
②	Flashlight (White LED) • This LED can be used as a small flashlight in a dark place.
③	A-band BUSY/TX lamp B-band BUSY/TX lamp These lamps light green during reception and red during transmission.
④	PTT switch • While switch is being pressed: Transmission. • The Set mode ends when switch is pressed during the Set mode.
⑤	MONI/T.CALL switch USA/EXP version While is being pressed: Squelch OFF European version While is being pressed: T.CALL (1750 Hz)
⑥	VOL switch • While pressing , turn : Volume level adjustment • Pressing during the sound is being muted cancels the Mute function.
⑦	Power switch • Press and hold over 1 second: Power on. • Press and hold over 1 second again: Power off. • Press : Key lock
⑧	MONO/DUAL (A/B) key (switching between operating bands) • Pressing each time switches between A-band and B-band. • Press and hold over 1 second: Changes the Dual Band Reception mode to the Mono Band Reception mode. • While operating the transceiver in the Mono Band Reception mode, press and then : Zooms in the display view.

⑨	SET/DISP key • Pressing each time switches between the Frequency and BACKTRACK screen. • Press and hold over 1 second: Enters the Set mode.
⑩	Battery pack*
⑪	DIAL Turn this dial to change the reception frequency or select a memory channel.
⑫	GPS antenna
⑬	MIC/SP jack* Connect a speaker microphone or earpiece microphone to this jack. It is not waterproofed when an external microphone is connected. Do not connect any microphone which is not specified by Yaesu. A failure can result.
⑭	EXT DC IN jack* • When charging the battery pack, connect the battery charger (PA-48 or SAD-11B) to this jack. • In the USA/EXP market , connect an external power supply adapter with a cigarette lighter plug (SDD-13) or an external power cable (E-DC-6) to this jack. Do not connect any battery charger which is not specified by Yaesu. A failure can result.
⑮	DATA terminal* • Use this terminal when using a clone function or updating the firmware. • Connect the optional camera-equipped microphone (MH-85A11U). • For how to update the firmware, access our home page.
⑯	Microphone
⑰	Display This LCD displays reception frequencies and various settings.
⑱	Speaker
⑲	15 keys These keys are used to specify reception/transmission frequency or select a function.
⑳	MW switch • Press Function switch • Press and hold over 1 second: Registers a frequency to a memory channel.

* When the included antenna and battery pack are installed and the MIC/SP jack, EXT DC IN jack, DATA terminal, and micro SD slot are securely covered with rubber caps, the FT1DR/DE meets the waterproofing performance conforming to IPX5 (See page 11).

Names and Functions of Controls

KEY	When pressed		When pressed and held over 1 second	The key is pressed after  pressed
	When entering a frequency or recalling a memory CH	When inputting a tag		
	Switches between radio wave types.	—	Starts WIRE-S-X	—
	Turns on/off the GM function.	—	—	—
	Determines the function selection	Moves the cursor to the right.	—	—
	Number “1”	Number “1”	—	Enables transmission power level switching.
	Number “2”	Number “2”, or Upper or Lower case characters “A”, “B”, “C”, “a”, “b”, or “c”	—	Enables scan operation.
	Number “3”	Number “3”, or Upper or Lower case characters “D”, “E”, or “F”, “d”, “e”, or “f”	—	Recalls a preset receiver memory channel
	Number “4”	Number “4”, or Upper or Lower case characters “G”, “H”, or “I”, “g”, “h”, or “i”	—	Enables home channel selection.
	Number “5”	Number “5”, or Upper or Lower case characters “J”, “K”, or “L”, “j”, “k”, or “l”	—	Enables reversal function.
	Number “6”	Number “6”, or Upper or Lower case characters “M”, “N”, or “O”, “m”, “n”, or “o”	—	Enables AF DUAL function.
	Number “7”	Number “7”, or Upper or Lower case characters “P”, “Q”, “R”, or “S”, “p”, “q”, or “r”, or “s”	—	Displays QSO LOG data.
	Number “8”	Number “8”, or Upper or Lower case characters “T”, “U”, or “V”, “t”, “u”, or “v”	—	—
	Number “9”	Number “9”, or Upper or Lower case characters “W”, “X”, or “Y”, “Z”, “w”, “x”, “y”, or “z”	—	Transmits APRS beacon.
	Number “0”	Number “0”	—	Displays APRS stations/APRS Message LIST.
	Increases the frequency band.	—	Enables band scope function.	Decreases the frequency band.
	Switches between the VFO mode and Memory Channel mode.	—	—	Enables dual watch function.
	—	Erases a character and the cursor moves to the left.	Enters the Memory Channel Registration mode.	—

Names and Functions of Controls

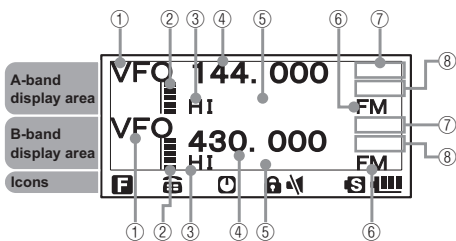

- ① Displays choice of the VFO mode or MR (memory channel) mode.
- ② Displays a sound volume bar graph.
- ③ Displays a transmission power level icon.
- ④ Displays an operating frequency.
- ⑤ S meter: Displays the radio wave strength in 9 steps.

PO meter: Displays the transmission power level in 4 steps.

H I: High power (5 W)

L 3: LOW 3 power (2.5 W)

L 2: LOW 2 power (1 W)

L 1: LOW 1 power (0.1 W)

- ⑥ Displays the operating mode (radio wave type).

FM FM (Analog) mode

■FM Auto mode (automatic switching among Analog AM, Analog FM, and Digital)

DN Wide digital mode (digital communication using C4FM modulation)

VW Wide digital mode (High quality digital communication)

- ⑦ Displays a squelch type (See page 84).

TN: Lights up when the tone encoder function is enabled.

TSQ: Lights up when the tone squelch function is enabled.

DCS: Lights up when the DCS function is enabled

RTN: Lights up when the reverse tone function is enabled.

PR: Lights up when the idle signal squelch function is enabled.

PAG: Lights up when the pager is enabled.

Displays the APRS baud rate (APRS function instruction manual).

- ⑧ Displays a shift direction during repeater operation (See page 40).

: Minus shift

: Plus shift

: Split operation

appears when the bell alarm function is active (See page 89).

Description of Icons

Icon	Description of operation
	Lights when a function key is pressed.
	Lights when the DTMF function is enabled (See page 79).
	Lights when the APO function is active (See page 127).
	Lights when the LOCK function is active (See page 39).
	Lights when the MUTE function is active (See page 35).
	Lights when a micro SD memory card is inserted.
H I	Displays the transmission power level (See page 36). H I: High power (5 W) L 3: LOW 3 power (2.5 W) L 2: LOW 2 power (1 W) L 1: LOW 2 power (0.1 W)

Icon	Description of operation
	Displays battery condition. : Full battery power : Enough battery power : Low battery power : Poor battery power. Charge battery. : Charge battery immediately (blink).

Preparation

Installing the Antenna

- 1 Align the antenna with the antenna terminal on the transceiver.
Caution Be sure to hold the thick base of the antenna when installing it.
- 2 Turn the antenna clockwise until it is secured.

Cautions

- Do not hold the upper part of the antenna when installing or removing it. To do so, the wire inside the antenna may break.
- Do not transmit without installing the antenna. The transmitter circuit can be damaged.
- When using an antenna other than the accessory or any other external antenna, ensure that its SWR is adjusted to 1.5 or lower.

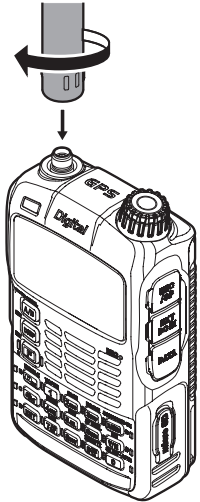

Attaching the Accessory Belt Clip/Protective Cap

Attaching the Protective Cap

- 1 Attach the protective cap
If you do not use the belt clip, attach the protective cap to the belt clip attaching screw holes on the battery pack.

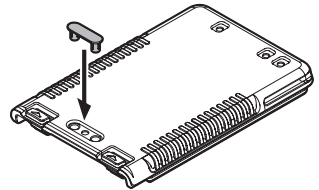

Attaching the Belt Clip

- 1 Turn over the battery pack.
- 2 Attach the belt clip to the battery pack using the supplied screws (two).

Cautions

- Be sure to use the supplied screws when attaching the belt clip. If any other screws are used, the belt clip cannot be secured firmly to the battery pack and the transceiver may drop off together with the battery pack, causing injury, breakage and other troubles.
- Be sure to attach the protective cap when the belt clip is not used.

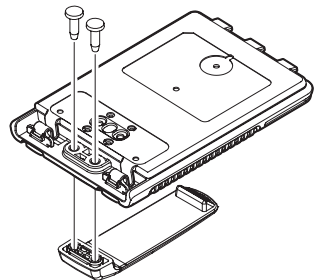

Attaching a Hand Strap

If you attach a hand strap to the transceiver, its string which is inserted in and secured to the strap hole of the transceiver must have a diameter of 1 mm.

* The hand strap is not an accessory.

- 1 Remove the battery pack.
- 2 Attach the hand strap.

Cautions

Use a hand strap which can withstand the weight of the transceiver. If you use a hand strap which is not strong enough, the hand strap can break and the transceiver fall down, causing injury, breakage and other troubles.

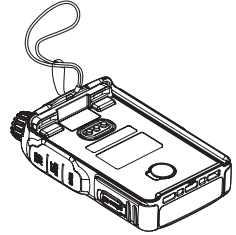

How to Use the Battery Case (FBA-39) — Optional

The optional battery case (FBA-39) allows three (size) AA Alkaline batteries to be used for the power supply.

Tips

When the battery case (FBA-39) is used, you can select a power output level from:

Low Power (L1): 0.1W

Low Power (L2): Approximately 0.8W

Note that Low Power (L3) and High Power are not available.

- 1 Open the cover.
Lift up the lower right corner indicated by the hand pointer in the illustration.
- 2 Put alkaline batteries in the battery case.
Caution Use three alkaline batteries. Pay attention to polarities (+ and -) of the alkaline batteries.
- 3 Close the cover.
Push the four corners of the cover firmly to close it tightly.

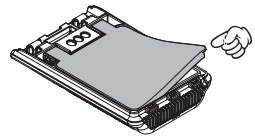

Tips

- When the battery charge is low,  lights on the LCD. When the batteries are almost exhausted,  blinks on the LCD.

Cautions

- Manganese batteries cannot be used. Rechargeable AA batteries cannot be used, either.
- Do not mix new and old batteries. The service life of new batteries may decrease.
- If you do not use the transceiver for a long period, remove the batteries from the battery case.
- If the terminal or electrode of the battery case is dirty, the transceiver can malfunction due to poor contact, resulting in overheating or explosion. If the terminal or electrode gets dirty, clean it using a dry cloth or cotton swab.

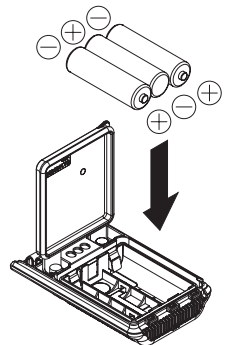

Installing/Removing the Battery Pack

Installing the Battery Pack

- 1 Insert the bottom tabs of the battery pack in the slots at the bottom of the transceiver.
- 2 Push the battery in until the latches click securely.

Caution

- When you use the transceiver for the first time after purchase or you have not used it for a long period, charge the battery pack before use.

Caution

- Risk of explosion if battery is replaced by an incorrect type. Dispose of used batteries according to the instructions..

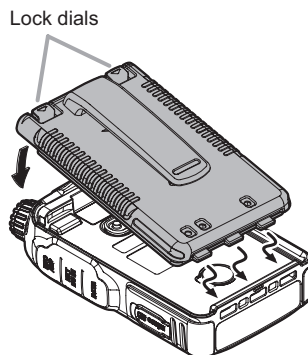

Removing the Battery Pack

- 1 While pushing down and releasing the latches, remove the battery pack, as shown in the battery pack removal illustration.

Caution

- When releasing the battery latches, be careful not to hurt your fingers and nails.

Push down on the latches in the direction of the arrow.

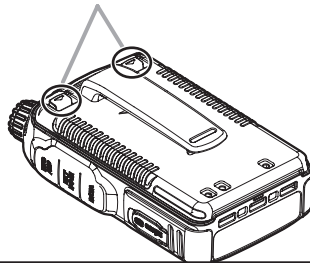

Charging the Battery Pack

Cautions

- The battery pack is rechargeable about 300 times. However, improper use such as overcharge or over-discharge can shorten its service life.
- The battery pack is a consumable item. Recharging the battery pack repeatedly will gradually shorten the duration of its usage.
- If the transceiver is not used for a long period with the battery pack installed, deterioration of the battery pack can accelerate.
- If you do not use the transceiver for a long period, be sure to store it with the battery pack removed. Even if you do not use the transceiver for a long period, install the battery pack biannually and recharge the battery pack about 50% to prevent it from over-discharging.
- Storing the battery pack in a high-temperature place can deteriorate it faster than usual. Store the battery pack in a place where the ambient temperature is -20°C to $+50^{\circ}\text{C}$ (-4°F to $+122^{\circ}\text{F}$).
- Do not drop or give a strong shock to the battery pack. It can break.

Tips

- The battery pack contains lithium-ion batteries that can be recharged for repetitive use.
- The transceiver can be used with either of the following battery packs:
 - (1) Accessory: FNB-102LI (7.4 V, 1,800 mAh)
 - (2) Option: FNB-101LI (7.4 V, 1,100 mAh)
- When the battery pack is recharged, its output voltage (about 8 V) becomes higher than the specified value (7.4 V). This is not a failure.

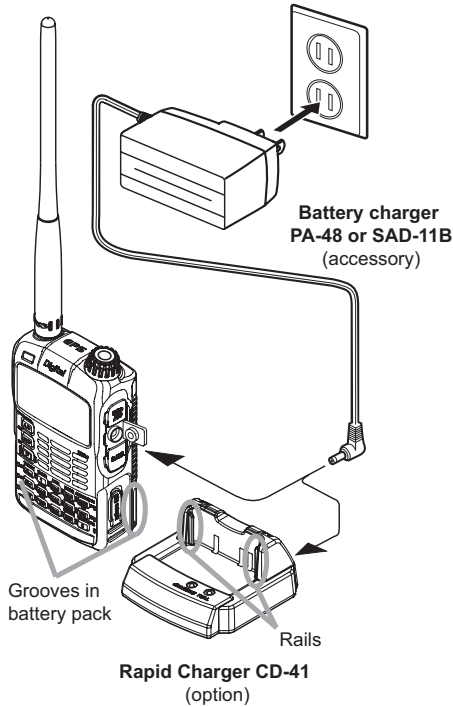



- 1 Install the Battery Pack
- 2 Turn off the transceiver.
- 3 Insert the plug of the battery charger (PA-48 or SAD-11B) in the EXT DC IN jack of the transceiver. Charging starts.

While the battery is being charged, the display will indicate "NOW CHARGING".

The charge level is indicated by a bar graph.

It takes about 8 hours to charge the battery pack fully.

When charging is completed, the display will change to indicate "COMPLETE" and the  lamp will glow green.

Remark In the USA Version, the  lamp is not lit when charging or when charging is complete. When the charge is complete, the transceiver turns off after 3 minutes.

Supplement • It takes about 5 hours to charge the FNB-101LI (option).

- The optional Rapid Charger (CD-41) requires about 4 hours to charge the supplied battery pack (about 2.5 hours to charge the optional battery pack FNB-101LI).

Place the battery pack on the CD-41 so that the rails of the CD-41 fit into the grooves on the battery pack.

When charging the battery pack using the CD-41, the LED on the CD-41 indicates the state of charging.

During charging: Lights red → Fast blink → Slow blink

Completion of charging: Lights green

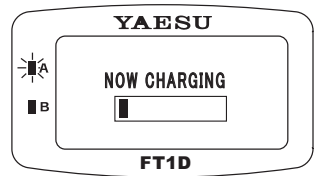

- 4 When charging is complete, remove the plug of the battery charger from the jack of the transceiver.

Cautions

- Neither transmission nor reception can be performed while charging the battery pack using the supplied battery charger.
- Charging may cause noise in the nearby TV or radio. Charge the battery pack with the battery charger as far away as possible from a TV or radio.
- If “BATTERY NOT INSTALLED” appears on the LCD and the battery pack cannot be charged after lapse of 11 or more hours, stop charging the battery pack immediately. If the same message appears again, the battery pack is presumably at the end of its service life or defective. If so, replace the battery pack with a new one.
- While charging the battery pack, protect the transceiver from water.
- Charge the battery pack in a place where the ambient temperature is +5 °C to +35 °C (+41 °F to +95 °F).
- If the terminal or electrode of the battery case is dirty, this transceiver can malfunction due to poor contact, resulting in overheating or rupture. If the terminal or electrode gets dirty, clean it using a dry cloth or cotton swab.

Tips

- The battery charger may become hot during charging. This is not a malfunction.
- If  starts blinking, the battery pack charge is depleted. Charge it immediately.

Approximate Operating Time and Remaining Charge Level Indication

Approximate time to operate the transceiver with the fully charged battery pack or three new AA alkaline batteries is as follows:

Band in Use Digital: OFF		Battery pack FNB-101LI	Battery pack FNB-102LI	Battery FBA-39
Amateur Band	144 MHz band	Approx. 5.0 hours	Approx. 8.0 hours	Approx. 15.5 hours
	430 MHz band	Approx. 4.5 hours	Approx. 7.5 hours	Approx. 15 hours
AM Broadcast Band		Approx. 10.0 hours	Approx. 16.0 hours	Approx. 18.0 hours
FM Broadcast Band		Approx. 8.0 hours	Approx. 13.0 hours	Approx. 14.5 hours

Band in Use Digital: ON		Battery pack FNB-101LI	Battery pack FNB-102LI	Battery FBA-39
Amateur Band	144 MHz band	Approx. 4.0 hours	Approx. 6.5 hours	Approx. 11.0 hours
	430 MHz band	Approx. 3.6 hours	Approx. 6.0 hours	Approx. 10.5 hours

Transmission 6 seconds: Reception 6 seconds (VOL Level 16): Stand By 48 seconds (SAVE1:5)

Remark Approximate hours are estimated assuming that the transceiver is operated under the following conditions. The operation time that this transceiver can be actually used varies depending on use conditions, ambient temperature, etc.

- When the GPS function is deactivated.
- When the transceiver is repeatedly operated by high-power transmission for 6 seconds and reception for 6 seconds, and standby for 48 seconds with an amateur ham radio band selected.

Connecting an External Power Supply for Use in Vehicle (USA/EXP version only)

The optional external power supply adapter with a cigarette lighter plug (SDD-13) allows the transceiver to be used in a vehicle.

- 1 Turn off the transceiver.
- 2 Insert the plug of the external power supply adapter with a cigarette lighter plug (SDD-13) in the EXT DC IN jack of the transceiver.
- 3 Insert the cigarette lighter plug of the external power supply adapter (SDD-13) in the cigarette lighter socket of the vehicle.

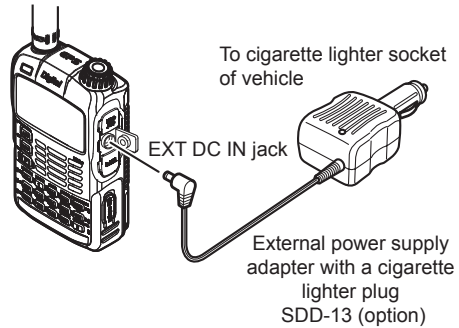

Cautions

- The SDD-13 is compatible with a 12 VDC cigarette lighter socket. Do not connect the SDD-13 to the 24 VDC cigarette lighter socket.
- Use the transceiver at the minimum required transmission power level to prevent overheating.
- Do not continue transmission for a prolonged period of time. The transceiver may overheat, resulting in malfunction or burns.
- If you operate the transceiver for 7 hours or longer, it is recommended that you remove the battery pack and install the optional battery case (FBA-39).
- Recharging the fully-charged battery pack repeatedly can shorten its service life. Be extremely careful not to do so when you operate the transceiver when using an external power supply.
- While charging the battery pack, protect the transceiver from water.
- Charge the battery pack in a place where the ambient temperature is +5 °C to +35 °C (+41 °F to +95 °F).
- If the terminal or electrode of the battery case is dirty, the transceiver can malfunction due to poor contact, resulting in overheating or rupture. If the terminal or electrode gets dirty, clean it using a dry cloth or cotton swab.

Tips

- The battery pack can be charged within approximately 8 hours using the external power supply (approximately 5 hours to charge the optional battery pack FNB-101LI). If the battery pack is charged with the transceiver turned on, the charging time increases slightly.
- When the battery pack has been fully charged, charging stops automatically.
- The external power supply can be used with the battery case installed.
- If you connect the transceiver to the external power supply with it turned off, "CONNECTED TO EXTERNAL POWER" appears on the LCD, and about 20 seconds later "BATTERY NOT INSTALLED" appears.

Connecting to an External Power Supply Using a Power Cable (USA/EXP version only)

The optional power cable (E-DC-6) allows the transceiver to be connected to an external power supply.

- 1 Turn off the transceiver.
- 2 Connect the optional external power supply cable (E-DC-6) to an external power supply.

Remarks

- Connect the red/black wire or white/red wire to the positive (+) terminal of the external power supply and the black wire to the negative (-) terminal.
- Set the voltage of the external power supply to 12 to 14 V.

- 3 Insert the plug of the external power supply in the EXT DC IN jack of the transceiver.

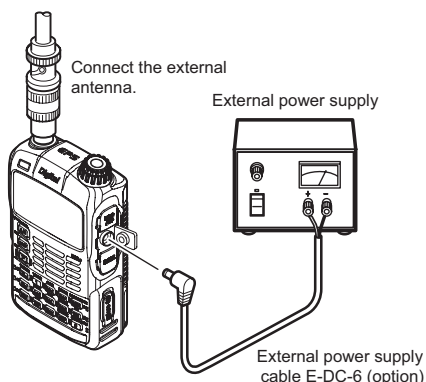

Cautions

- When you use the transceiver with the external power supply cable (E-DC-6) connected to an external power supply, pay attention to the following:
 - The power supply voltage must be between 12 V and 14 V.
 - If the voltage exceeds 14 V, the high voltage protection function is activated to disable high-power transmission. L3 (2.5 W) is selected automatically to reduce the transmission power. If the voltage exceeds 16 V, malfunctions such as damage to the electric circuits of the transceiver may result. Take extra care.
 - Connect the red/black wire or white/black wire of the external power supply cable (E-DC-6) to the positive (+) terminal of the external power supply and the black wire to the negative (-) terminal.
 - Use an external power supply having sufficient current capacity (3 A or more).
 - If the transceiver is used with supplied antenna connected, the external power supply can malfunction, resulting in a failure. If you use an external power supply, remove the supplied antenna and connect an external antenna. Place the external power supply sufficiently away from the transceiver.
 - Use the transceiver at the minimum required transmission power level to prevent overheating.
 - Do not continue transmission for a prolonged period. The transceiver may overheat, resulting in malfunction or burn.
 - If you operate the transceiver for 7 hours or longer, it is recommended that you remove the battery pack and install the optional battery case (FBA-39).
 - Recharging the fully-charged battery pack repeatedly can shorten its service life. Be extremely careful not to do so when you operate the transceiver using an external power supply.
 - While charging the battery pack, protect the transceiver from water.
 - Charge the battery pack in a place where the ambient temperature is +5 °C to +35 °C (+41 °F to +95 °F).
 - If the terminal or electrode of the battery case is dirty, the transceiver may malfunction due to poor contact, resulting in overheating or rupture. If the terminal or electrode gets dirty, clean it using a dry cloth or cotton swab.

Tips

- The transceiver can be charged within approximately 8 hours using the external power supply (approximately 5 hours to charge the optional battery pack FNB-101LI). If the battery pack is charged with the transceiver turned on, the charging time increases slightly.
- The external power supply can be used with the battery case installed. If you connect the transceiver to the external power supply with it turned off, "CONNECTED TO EXTERNAL POWER" appears on the LCD, and about 20 seconds later "BATTERY NOT INSTALLED" appears.

Using a microSD memory card

Using a microSD memory card with the transceiver allows the following functions.

You can:

- Back up information on the transceiver.
- Save memory information.
- Save data other than images.
- Save GPS log data.
- Save image data captured with the optional camera-equipped microphone (MH-85A11U).
- Save messages downloaded with the GM function or WIRES-X function.

Usable microSD memory cards

This transceiver only supports the following capacity of microSD and microSDHD memory cards.

• 2GB • 4GB • 8GB • 16GB • 32GB

Cautions when using a microSD memory card

- Do not bend or place heavy objects on the microSD memory card.
- microSD memory cards formatted on other devices may not properly save information when used with this transceiver. Format microSD memory cards again with this transceiver when using memory cards formatted with another device.
- When saving data to a microSD memory card, do not remove the microSD memory card or turn off the transceiver.
- Do not insert anything other than microSD memory card into the microSD memory card slot of the transceiver.
- Do not attempt to forcefully remove mounted microSD memory card.
- Do not use microSD memory cards other than those specified by Yaesu. For the information on the specified products, please contact Yaesu Amateur Ham Radio Customer Support.

Mounting and dismounting microSD memory card

- 1 Turn off the transceiver.

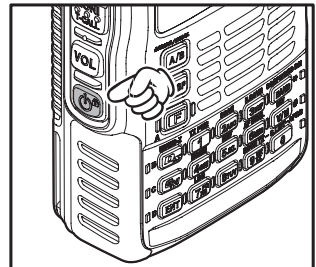

- 2 Open the microSD cover on the side of the transceiver.

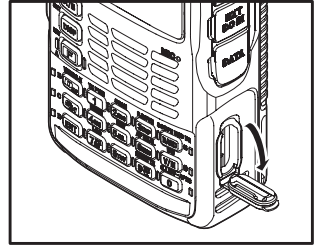

- 3 Insert the microSD memory card into the card slot until you hear a click. (as shown in the figure at the right).

- Cautions**
- Ensure that the microSD memory card is facing the proper direction when mounting it.
 - Do not touch the terminal of the microSD memory card.

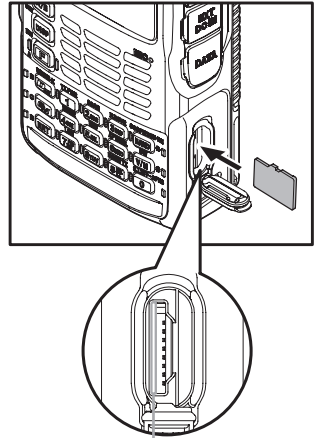

Do not push the microSD memory card into this space.

- 4 Close the microSD cover.
When the microSD memory card is properly detected, the **S** lights on the display.

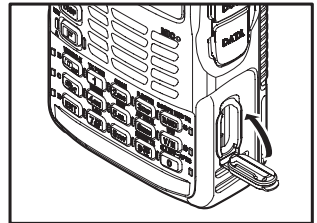

Tips

Dismounting the microSD memory card.

To dismount the microSD memory card, as done in step 3 above, push the memory card in until you hear a click, then remove the memory card.

* By using the micro SD Card Clip, it is easy to remove the micro SD memory Card.

Caution

Do not turn off the transceiver while the data is being written to the microSD memory card. Doing so may corrupt the data.

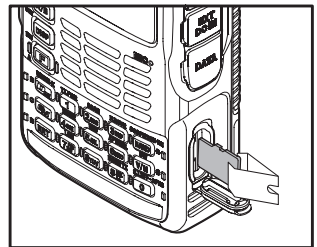

Formatting a microSD memory card

Format a new microSD memory card following the steps below before use.

Caution

Formatting a microSD memory card erases all data saved to it. If you are going to format the microSD memory card you are using, be sure to check the data saved to it before formatting.

1 Press and hold **SET** (**DISP**) over 1 second.

2 Turn **DIAL** to select [10 SD CARD].

3 Press **ENT**.

4 Turn **DIAL** to select [4 FORMAT].

5 Press **ENT**.

[OK?] appears on the LCD.

Tip To cancel formatting, select [Cancel].

6 Press **ENT**.

S (**S** icon) on the LCD blinks and formatting starts.

When formatting is completed, a beep sound is emitted and [Completed] appears on the LCD.

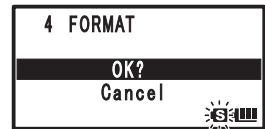
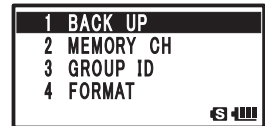
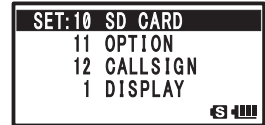

Blinking while formatting is in progress

Performing Communication

Try communication using the transceiver in the analog communication mode.
Follow the procedure below:

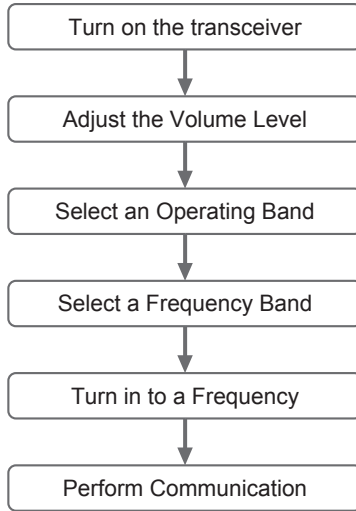

Turning on the Transceiver

1 Press and hold  over 1 second.

2 The callsign input screen appears.

The callsign input screen appears when the transceiver is turned on for the first time after purchase.

The next time, the frequency screen will appear after the opening screen.

3 Input a callsign for your transceiver.

Input the callsign with the ten key.

4 Press .

The callsign is set and two frequencies (A-band and B-band frequency) appear at the same time.

Supplement Factory settings are:

A-band (upper): 144.000 MHz

B-band (lower): 430.000 MHz

Tips You can change the information such as the power supply voltage and the opening message displayed at power-on. For example, press and hold  over 1 second to enter the Set mode and then select [1 DISPLAY] → [9 OPENING MESSAGE] to change the opening message.

In addition, you can set the transceiver to display the reception frequency immediately without displaying the opening message (See page 107).

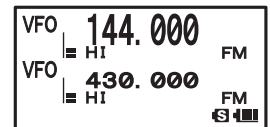
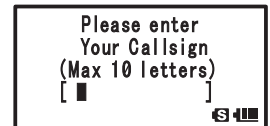
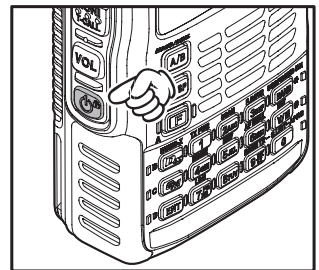



•Turning off the Transceiver



To turn off the transceiver, press and hold  over 1 second.

Adjusting the Volume Level

You can adjust the transceiver volume level for the A-band and B-band separately.

- 1 Press  to select the A-band or B-band for which you want to adjust the volume level.

Pressing  each time toggles between the A-band and B-band.



- 2 While pressing , turn  to adjust the volume level.

The volume bar graph moves up/down.

Supplement If no sound is heard from the speaker, press  and then adjust the volume level while listening to white noise.

- 3 Release  to exit from the Volume Level Adjustment mode.

Tips

- Pressing  starts MUTE (silencing the audio) function, muting entire sound.
- Pressing  while the audio is being muted cancels the MUTE function.

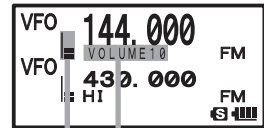
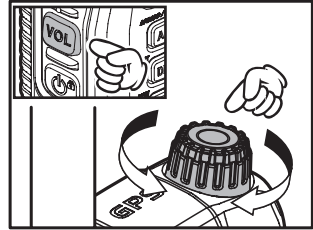

Sound Volume Bar Graph

A "SP VOLUME" level among 0 trough 31 appears.

Selecting an Operating Band

The frequency displayed on the LCD in large letters is the operating band.

You can change the frequency of the operating band and activate the transmitter.

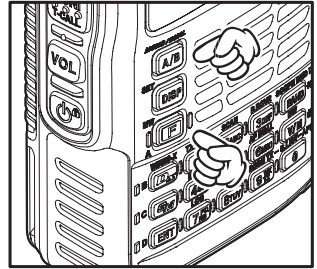

Each time ^{MONO/DUAL} (A/B) is pressed, the operating content displayed on the LCD screen is changed.

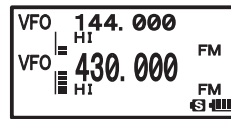
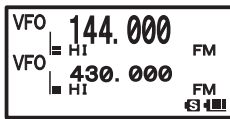
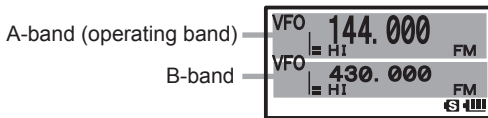

Press and hold ^{MONO/DUAL} (A/B) about 1 second.

Press and hold ^{MONO/DUAL} (A/B) about 1 second.

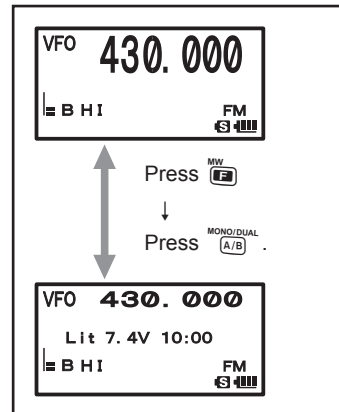
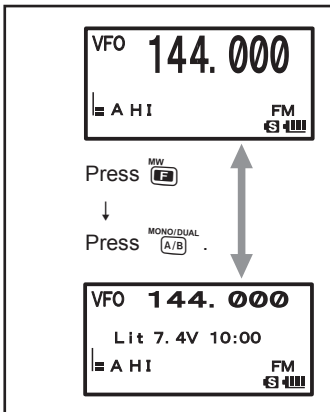

Tip

- On A-band, you can transmit and receive using the 144 MHz and 430 MHz Amateur radio bands.
- On B-band, you can transmit and receive using the 144 MHz and 430 MHz Amateur radio bands.

In addition, the frequencies on the chart below can be received on A-band and B-band.

Chart of A-band and B-band reception frequencies

A-band and B-band reception frequencies

A-band	B-band
0.5 MHz to 1.8 MHz (AM BC Band)	--
76 (88) MHz to 108 MHz (FM BC Band)	--
1.8 MHz to 30 MHz (SW band)	--
30 MHz to 76 (88) MHz (50 MHz band)	--
108 MHz to 137 MHz (AIR band)	108 MHz to 137 MHz (AIR band)
137 MHz to 174 MHz (144 MHz band)	137 MHz to 174 MHz (144 MHz band)
174 MHz to 222 MHz (VHF-TV Band)	174 MHz to 222 MHz (VHF-TV Band)
222 MHz to 420 MHz (INFO band (1))	222 MHz to 420 MHz (INFO band (1))
420 MHz to 470 MHz (430 MHz band)	420 MHz to 470 MHz (430 MHz band)
470 MHz to 774 (800) MHz (UHF-TV Band)	470 MHz to 580 MHz
803 (800) MHz to 999.9 MHz Cellular Blocked USA version	--

(): EXP/European version

- A-band and B-band can be received at the same time.
You can receive Amateur radio frequency while listening to the AIR band, or receive two Amateur radio frequencies on the same frequency band at the same time (V+V/U+U: Dual frequency reception on the same band).

Selecting a Frequency Band

You can select a frequency band to use for the A-band and B-band separately.

•Setting a Frequency Band for the A-band

- 1 Press $\overline{\text{MONO/DUAL}}$ $\left[\begin{matrix} \text{A/B} \\ \text{A/B} \end{matrix} \right]$ to select the A-band.
- 2 Press $\overline{\text{SCOPE BAND DN}}$ $\left[\begin{matrix} \text{BAND} \\ \text{BAND} \end{matrix} \right]$ repeatedly to select a frequency band.

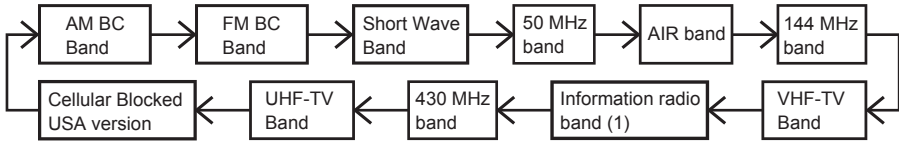

Tip Pressing $\overline{\text{MW}}$ $\left[\begin{matrix} \text{MW} \\ \text{MW} \end{matrix} \right]$ and then $\overline{\text{SCOPE BAND DN}}$ $\left[\begin{matrix} \text{BAND} \\ \text{BAND} \end{matrix} \right]$ changes frequency bands shown above in the reverse order.

•Selecting a Frequency Band for B-band

- 1 Press $\overline{\text{MONO/DUAL}}$ $\left[\begin{matrix} \text{A/B} \\ \text{A/B} \end{matrix} \right]$ to select the B-band.
- 2 Press $\overline{\text{SCOPE BAND DN}}$ $\left[\begin{matrix} \text{BAND} \\ \text{BAND} \end{matrix} \right]$ to select a frequency band.

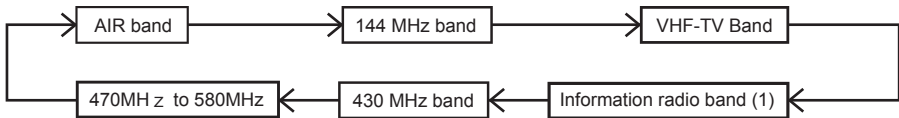

Tip Pressing $\overline{\text{MW}}$ $\left[\begin{matrix} \text{MW} \\ \text{MW} \end{matrix} \right]$ and then $\overline{\text{SCOPE BAND DN}}$ $\left[\begin{matrix} \text{BAND} \\ \text{BAND} \end{matrix} \right]$ changes frequency bands shown above in the reverse order.

Caution

- Digital communication can be performed only on the A-band.
Digital communication cannot be performed on the B-band.

Tips



- The frequency settings from the factory are:
A-band: 144.000 MHz B-band: 430.000MHz
- The factory setting of the Auto mode is set such that the transceiver is automatically switched to the optimal reception mode for the default frequency bands.
To change the default reception mode, press and hold $\overline{\text{SET DISP}}$ $\left[\begin{matrix} \text{SET} \\ \text{DISP} \end{matrix} \right]$ for over 1 second and then select [2 TX/RX] → [1 MODE] → [4RX MODE] (See page 38).
- For the relationship between frequency bands and reception frequencies, see the table on page 28.
- You can also recall the home channel of each frequency band by pressing $\overline{\text{MW}}$ $\left[\begin{matrix} \text{MW} \\ \text{MW} \end{matrix} \right]$ and then $\overline{\text{HOME}}$ $\left[\begin{matrix} \text{HOME} \\ \text{4ch} \end{matrix} \right]$ (See page 45).

Tuning in to a Frequency

Tune in to your desired frequency using either of the following methods:

- (1) Turn  to tune in to your desired frequency.
- (2) Enter your desired frequency directly using the numeric keys.

•Tuning in to your desired frequency with .

- 1 Switch to the VFO mode.
- 2 Turn  to tune in to your desired frequency.
Turning  clockwise: The frequency increases.
Turning  counterclockwise: The frequency decreases.

Tip You can tune to the desired frequency in steps of 1 MHz by pressing  and turning .

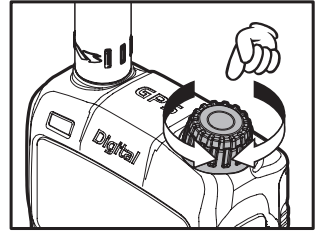

•Entering a Desired Frequency Directly Using Numeric Keys

- 1 Press  to enter the VFO mode, in which you can tune to the desired frequency.
- 2 Enter the desired frequency using numeric keys.

Example: To enter 145.520 MHz, Press the  the following keys in sequence:



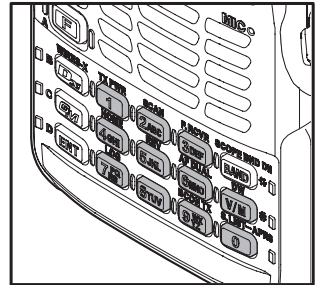

 1 →  4GH →  5JKL →  5JKL →  2ABC

Example: To enter 430.000 MHz, Press the  the following keys in sequence:

 4GH →  3DEF → 



Tips

- In factory settings, the Auto Step mode is set such that the transceiver is automatically switched to the optimal frequency steps for the reception frequency.
You can change frequency steps manually using  (See page 37).
- If you enter a wrong digit when entering a frequency using numeric keys, you can cancel it by pressing .
- In factory settings, turning  beyond the selected frequency band does not change the selected frequency band to another frequency band and displays the selected frequency band repeatedly on the LCD.
To prevent it, press and hold  for over 1 second to switch to the Set mode, select [8 CONFIG] → [21 VFO MODE] and change the [21 VFO MODE] to "ALL". Thereby, you can change the frequency band to another frequency band by turning  beyond the selected frequency band.





Selecting Communication Mode

This transceiver can operate in both analog and digital communication modes.

Pressing  repeatedly switches the communication mode as follows.

[Analog (FM)] → [Auto (FM)] → [Digital (DN)] → [Digital Wide (VW)]

FM: Analog Analog communication using FM mode.

  Auto Automatically switches between Analog AM (AM), Analog FM (FM), and Digital (DN).

DN: Digital Digital communication using (C4FM (Quaternary FSK) modulation

VW: Wide Digital High sound quality of Digital Communication

Caution

- Digital communication can be performed only on the A-band.

Performing Communication

1 Speak into the microphone while pressing .

When speaking into the microphone, keep it about 5 cm away from your mouth.





2 Release .

The transceiver returns to the Reception mode.

Cautions

- Use the transceiver at the minimum required transmission power level.
- Doing so prevents the transceiver from overheating and saves battery power, increasing the operating time.
- Do not continue transmitting for a prolonged period. The transceiver can overheat, resulting in malfunction or burn.
- If transmission is continued for a long period, the transceiver overheats and the overheat protection function is activated. As a result, the transmitting power level is automatically set to Low Power. If you continue transmitting while the overheat protection function is active, the transceiver will be forcibly returned to the Reception mode.
- If you touch the transceiver immediately after the overheat protection function has become active, you can get burned. Wait for the temperature inside the transceiver to drop sufficiently before resuming transmission.
- Do not perform transmission without attaching the antenna. The transmitter circuit can be damaged.

Tips

- In the FM mode, you can transmit on the 144 MHz and 430 MHz ham radio bands.
 - Even while you are receiving in the AM mode, you can transmit in the FM mode by pressing .
 - You can change the transmit power level by pressing  and then .
- Transmit power level may be lower when using the battery pack or the alkaline battery case. For more details, see “Changing the Transmission Power Level” on page 36.
- If  is pressed when a frequency other than the amateur ham radio band is selected, an alarm tone (beep) will be emitted and “ERROR” appears on the LCD, disabling transmission.
 - Pressing and holding  for over 1 second, and changing the Set Mode option [8 CONFIG] will allow you to use the transceiver more conveniently.
 - Selecting [8 CONFIG] → [2 BCL0] prohibits transmission during reception of a signal.

Selecting Communication Mode



This transceiver is equipped with AMS (Automatic Mode Select) which automatically selects between 4 modes of transmission to fit the signal being received. Because the transmission is automatically adjusted to that of the other station, not only C4FM digital signals, but analog signals are also recognized.

Press  to display [■DN*] on the LCD.

* (The display depends on the received signal.)



Example of when AMS is displayed.

To fix the transmission mode for operation, switch the transmission mode with . Pressing  toggles between communication modes in the order listed below.

[■DN (AMS)] → [DN (V/D mode)] → [VW (FR mode)] → [FM (analog)]

Operation mode	Display	Description of Modes
AMS (Automatic Mode Select)	■○○	Transmission mode is automatically selected from 4 types according to the signal received. (“○○” part differs depending on the received signal.) The AMS feature settings may be changed via Set Mode (p.112).
V/D Mode (Voice/Data simultaneous transmission mode)	DN	Call is less prone to interruption due to detection and correction of voice signals during digital voice signal transmission. This is the standard mode for C4FM FDMA Digital
Voice FR Mode (Voice Full Rate Mode)	VW	Digital voice data transmission using the entire 12.5kHz band. Enables high-quality voice communication.
Data FR Mode (High Speed Data Communication Mode)		High speed data communication using entire 12.5kHz band. This mode is automatically selected for image communication.
Analog FM Mode	FM	Analog communication using FM mode. Effective when the signal is weak and audio is susceptible to interruption in digital mode.



Cautions

- Digital communication can be performed only on the A-band.
- Digital communication cannot be performed on the B-band.
- In V/D mode (“DN” on the LCD), position information is included in the radio wave during voice communication, however, it is not include in the Voice FR mode (“VW” on the LCD).



Listening to the Radio

Listening to the AM/FM Radio

AM broadcast stations can be easily received using “Preset Memory Receiver” (See page 52), where many major broadcast stations are already saved to this transceiver, or the stations can be directly tuned in by inputting the frequency of the desired broadcast station with the  and key pad.

- 1 Press .
Set A band as the operating band.
- 2 Press .
Select either the “AM broadcast” or “FM broadcast” bands. The “**RM**” icon will appear on the display while in the Broadcast Reception mode.
- 3 Adjust the frequency by turning  or using the key pad (See page 30).









Tip

- Broadcast stations that are frequently listened to can be saved to memory (See page 43).
- If you would like to scan a radio band, set A band as the operating band and press , then .
- If a signal is detected during the scan, a beep will sound; the transceiver will receive the signal for 5 seconds then resume scanning.
- The decimal point will flash when the scan is stopped.

Switching between AM Antennas

When listening to AM broadcast stations, the Bar and external antennas may be switched for best reception according to conditions. During normal use, you may not need to switch between AM antennas.

Enter the Set mode:

- 1 Press and hold  for over 1 second.
- 2 Turn  to select [2 TX/RX].
- 3 Press .
- 4 Turn  to select [1 MODE].
- 5 Press .
- 6 Turn  to select [1 ANTENNA AM].
- 7 Press .
- 8 Turn  to switch to the desired antenna.

Display	Operation
BAR & EXT ANTENNA	AM broadcasts can be received using both the whip antenna provided at the top of the transceiver and the built-in bar antenna.
BAR ANTENNA	When receiving AM broadcasts, the transceiver uses only the built-in bar antenna. Rotate the transceiver to adjust the AM broadcast (middle wave band) for the best receiving sensitivity.

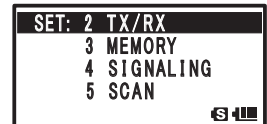







- 9 Press  to exit from the Set mode.

Miscellaneous Settings

Setting clock time

This transceiver is equipped with an internal clock. The clock is used to display the time, and also to turn the transceiver on or off at a specified time (timer function). Set the clock before using the transceiver for the first time.

Enter the Set mode:

- 1 Press and hold  for over 1 second.
- 2 Turn  to select [8 CONFIG].
- 3 Press .
- 4 Turn  to select [19 DATE & TIME ADJ].
- 5 Press .
- 6 Turn  to set [YEAR].
- 7 Press .

The cursor moves to [MONTH].

- 8 Turn  to set [MONTH].
- 9 Repeat steps 5 and 6.

Set [DAY], [HOUR], and [MINUTE]

Pressing  moves the cursor to the setting item shown on the left.

Remark The hour appears in the 24-hour clock format.

Tip If GPS information is received, the clock will be set automatically.

Next, set the time signal alarm.

If you do not want to set the time signal alarm, proceed to step 3 described in “Setting the Time Signal”.

Setting the Time Signal

Set the time signal so that a tone is emitted at 00 minute of each hour.

- 1 Press .

The cursor moves to [—].

- 2 Turn  to select “SIG”.

If you select [TIME SIGNAL] you will hear a time signal tone (beep) at 00 minute of each hour.

If you do not want to hear the time signal tone, leave “—” as it is.

- 3 Press .

The cursor moves to [SET].

- 4 Press  to save the [TIME SIGNAL] setting.

- 5 Press  to exit from the Set mode.

Remark When “MONOBAND RECEPTION” is selected, the current time appears on the LCD.

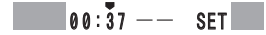
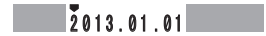









Tips

- The accuracy of the clock is 30 seconds/month. However, it may vary depending on the environment conditions, such as the temperature.
- The transceiver is equipped with a dedicated rechargeable lithium battery for the clock. Normally, the transceiver is powered from the battery pack. When the battery pack is detached or runs out, the lithium battery starts operating automatically. The lithium battery can power the clock for approximately 2 months.
- When you use the transceiver for the first time or without the battery pack for a long period of time, the accuracy of the clock may be poor. In such case, reattach the battery pack and adjust the time.
- When the transceiver is operating in “Mono” band, the current time appears on the LCD. However, when display of double-size characters or dual display is selected, the current time does not appear on the LCD.
- The calendar can display dates from January 1, 2000 A.D. up to December 31, 2099 A.D.
- If AUTO is selected in [9 APRS] → [21 GPS TIME SET] in the Set mode, the clock will automatically display accurate time. However, the day of the week is not set automatically. Set the day of the week manually.
- If you use the timer function, the transceiver will be turned off automatically (See page 132). In addition, you can set the transceiver to turn on at the specified time (See page 132).

Muting Audio

If it is difficult to hear the voice because the audio of A-band and the B-band are mixed during dual reception, you can mute the audio of the non-operating band.

- 1 Press and hold  for over 1 second to select the Set mode.
- 2 Turn  to select [2 TX/RX].
- 3 Press .
- 4 Turn  to select [3 AUDIO].
- 5 Press .
- 6 Turn  to select [2 MUTE].
- 7 Press .
- 8 Turn  to select a mute level.

Remark You can select one of the following 4 levels of mute:

- MUTE 30%
- MUTE 50%
- MUTE 100%
- OFF

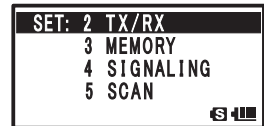

The higher the value for MUTE, the more the non-operating band audio is reduced.

To deactivate the muting function, select OFF.





Miscellaneous Settings

9 Press  to exit from the Set mode.

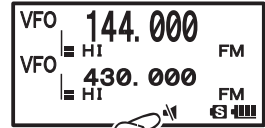
Remark When the muting function is active,  appears on the LCD.
When the muting function is active,  blinks on the LCD.



Tips

- Even if the muting function is activated, the voice is not muted when no signal is received on the operating band.
- Pressing  while in frequency display screen, zooms in on [MUTE] and both A and B bands can be muted simultaneously.
Pressing  again will deactivate MUTE.

Changing the Transmission Power Level

The maximum transmission power level of this transceiver is 5W. When communicating with a friend in the immediate area or when you want to reduce the battery power consumption, you can lower the transmit power level. For power supply types and transmit power levels, see the table shown below.

1 Press  and then  (1).

2 Turn  to select the transmit power level.

Select [LOW1], [LOW2], [LOW3], or [HIGH] by turning .

3 Press  to save the selected transmit power level.

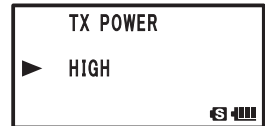

Battery type	HI (High Power)	L3	L2	L1
Battery pack	5 W	2.5 W	1 W	0.1 W
External power supply (13.8 VDC)				
Battery Case (alkaline battery)			Approx. 0.8 W	0.1 W

Tips

- You can set the transmitter power level separately for the A-band and B-band.
- Use the transceiver at the minimum required transmit power level to reduce battery power consumption.
- By default, "HI (High power)" is selected.

Adjusting the Squelch Level

You can mute the raspy noise heard when no signal is being received. The squelch level can be adjusted separately for two broadcasts (FM and AM) received on the A-band and B-band. When the squelch level is increased, the noise is more liable to disappear but, if it is set too high, it becomes difficult to receive weak signals. Adjust the squelch level as required.

- 1 Press to select the desired operating band.
- 2 On the FT1DR, press and then .
On the FT1DE, press and hold over 1 second to enter the Set mode, and then select [4 SIGNALING] → [8 SQL LEVEL].
- 3 Turn to adjust the squelch level.
Remark The squelch level can be adjusted within the range from 0 to 15.
Default: LEVEL 1
- 4 Press to save the Squelch Level Adjustment and exit the Squelch Level Adjustment mode.

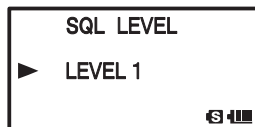

Tips

While is held pressed, the squelch function will be deactivated for both the A-band and B-band.

Changing the Frequency Step Manually

By default, “AUTO (Step)” is selected so that the optimum frequency step is automatically selected according to the received frequency. You can change this frequency step manually.

- 1 Press and hold over 1 second.
Enters the Set mode.
- 2 Turn to select [8 CONFIG].
- 3 Press .
- 4 Turn to select [18 STEP].
- 5 Press .
- 6 Turn to select your desired frequency step.

Remark Selectable frequency steps are as follows:

• AUTO	• 5 KHz	• 6.25 KHz
• (8.33 KHz)	• 10 KHz	• 12.5 KHz
• 15 KHz	• 20 KHz	• 25 KHz
• 50 KHz	• 100KHz	

It is recommended that AUTO be selected normally.

Default: AUTO

- 7 Press to save the frequency step, and exit the Frequency Step Setting mode.

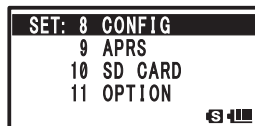

Miscellaneous Settings









Tips

- For the AIR band (108 MHz to 136.991 MHz), the frequency step “8.33 kHz” can be selected.
- For bands covering 250MHz to 300MHz, and bands covering 580 MHz or higher, the frequencies, frequency steps “5 kHz”, “6.25 kHz”, and “15 kHz” cannot be selected.

Changing the Mode Manually

By default, the reception (RX) is set to “AUTO (Auto Mode)” so that the optimal reception mode (radio wave type) is automatically selected according to the receiving band (frequency band). You can change this mode manually.

Enters the Set mode:

- 1 Press and hold  for over 1 second.
- 2 Turn  to select [2 TX/RX].
- 3 Press .
- 4 Turn  to select [1 MODE].
- 5 Press .
- 6 Turn  to select [4 RX MODE].
- 7 Press .
- 8 Turn  to select your desired reception mode.

It is recommended that AUTO be selected normally.

Display	Operation
AUTO	The optimal reception mode is automatically selected according to the frequency band.
FM	Only the selected band is switched to the NFM (FM mode).
AM	Only the selected band is switched to the AM mode.

- 9 Press  to exit the Set mode.

Tip



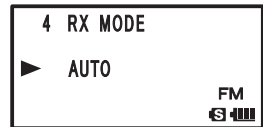
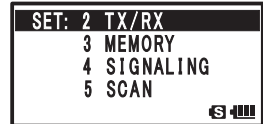

- Even if the AM mode is selected on a ham radio band, 144 MHz band or 430 MHz band, transmission takes place in the FM mode.

Caution

- You cannot change the mode of A-band AM/FM broadcast radio bands.





Locking keys and switches

To prevent accidental frequency change during operation, keys, switches and  except  switch, , ,  can be locked.

1 Press  to lock the keys and switches.

 appears on the LCD.

Remark To unlock a key or switch, press  again.

 disappears from the LCD.

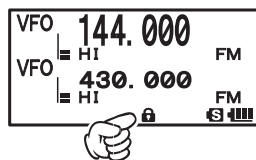

Tip

- You can also lock the  and  switch by selecting the Set mode option [8 CONFIG] → [9 LOCK].

Restoring to Defaults (All Reset)

You can restore all transceiver settings and memory content, such as memory channels, to the defaults.

1 Press  while pressing , , and .

The transceiver is turned on, followed by beep.

When you hear the beep, release the keys.

2 When “ALL RESET PUSH F KEY!” appears on the LCD, press .

A beep sounds and the callsign input screen appears on the LCD.

3 Input a callsign for your transceiver.

Input the callsign with the numeric keys.

4 Press  to save your callsign and the screen returns to the frequency display.

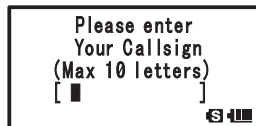
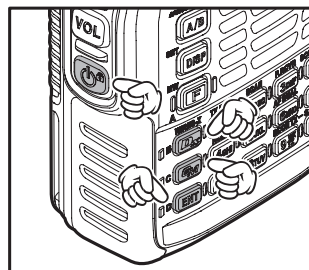

Remark To cancel the All Reset function, press a key or switch other than .



Caution

When the All Reset function is performed, all data such as memory channels registered in the memory is deleted. Be sure to write it down on paper or back up the data on the microSD memory card (See pages 138 to 139).



Tip

To return only the Set Mode option settings to default, press  while pressing  and .

Repeater Operation





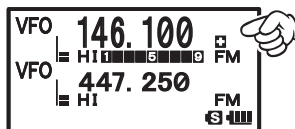

Communicating Via the Repeater

The transceiver includes an ARS (Automatic Repeater Shift) function which permits communication through the repeater automatically just by setting the receiver to the repeater frequency.





- 1 Set the receive frequency to the repeater frequency.
“” or “” appears in the upper right corner of the LCD.
- 2 Press , to begin communicating through the repeater.



Tips

- Pressing  and then pressing  enters the “reverse” state where the transmit frequency and the receive frequency are temporarily reversed. This allows you to check and find if direct communication with the remote station is possible.
- In the “reverse” state,  blinks on the LCD.
- Pressing  again and then  exits the “reverse” state.
- Press and hold  over 1 second to enter the Set mode and change the options to allow more convenient use of this function.
 - [8 CONFIG] → [14 RPT ARS] You can deactivate the ARS function.
 - [8 CONFIG] → [15 RPT SHIFT] You can set the repeater shift direction.
 - [8 CONFIG] → [16 RPT SHIFT FREQ] You can change the repeater shift step.

Tone Calling (1750 Hz)

If your transceiver is FT1DE (European version), press and hold in the  switch (just below the  switch) to generate a 1750 Hz burst tone to access the European repeater. The transmitter will automatically be activated, and a 1750 Hz audio tone will be superimposed on the carrier. Once access to the repeater has been gained, you may release the  switch, and use the  switch for activating the transmitter thereafter. If you need to access the repeaters which requires a 1750 Hz burst tone for access by the FT1DR (USA/EXP versions), you can set the  switch to serve as a “Tone Call” switch instead. To change the configuration of this switch, use Set Mode [8 CONFIG] → [10 MONI/T-CALL].

Repeater Shift







The FT1DR/DE has been configured, at the factory, for the repeater shifts customary in the country where it is sold. For the 144 MHz band, this usually will be 600 kHz, while the 430 MHz shift will be 1.6 MHz, 7.6 MHz, or 5 MHz (USA version).

Depending on the part of the band in which you are operating, the repeater shift may be either downward (-) or upward (+), and one of these icons will appear to the right of the display frequency on the LCD when repeater shifts have been enabled.

Automatic Repeater Shift (ARS)

The FT1DR/DE Automatic Repeater Shift feature causes the appropriate repeater shift to be automatically applied whenever it is tuned into the designated repeater sub-bands. If the ARS feature does not appear to be working, you may have accidentally disabled it.

To re-enable ARS:

- 1 Press and hold the  for over 1 second to enter the set mode.
- 2 Turn the  to select [8 CONFIG].
- 3 Press .
- 4 Turn the  to select [14 RPT ARS].
- 5 Press .
- 6 Turn the  to select "ON" (to enable Automatic Repeater Shift).
- 7 Press the  to save the new setting and exit the Set mode.

A Wide Variety of Memory Functions

The FT1DR/DE transceiver provides the following various types of memory channels in addition to the regular memory channels (numbers 001 to 900).

- [Home channels] which can be recalled on each frequency band with one touch of a key. (See page 45)
- Preset Receiver Memory Channels such as VHF Weather Broadcast Station (10 channels), international VHF (marine) radios (57 channels) and world broadcasts (89 channels) (see pages 51 to 55)
- 99 (901 to 999) skip search memory channels that allow you to skip unwanted frequencies during VFO scanning (See page 58)
- 50 sets of memory channels (L01/U01 to L50/U50) for programmable memory channels scanning (PMS) (See page 63)

The operating frequency and other operational information can be registered to each regular memory channel, home channel, or PMS memory channel:

- Operating frequency
- Memory tag
- Repeater information
- Tone information
- DCS information
- Transmission output
- Memory channel skip information

(The operating mode information is not registered to the memory channels)

Memory channels can be sorted and registered to memory banks according to the intended use. The transceiver allows you to use 24 types of memory banks. A maximum of 100 memory channels can be registered to each memory bank. A name can be assigned to each memory bank with up to 16 characters. (See page 48)

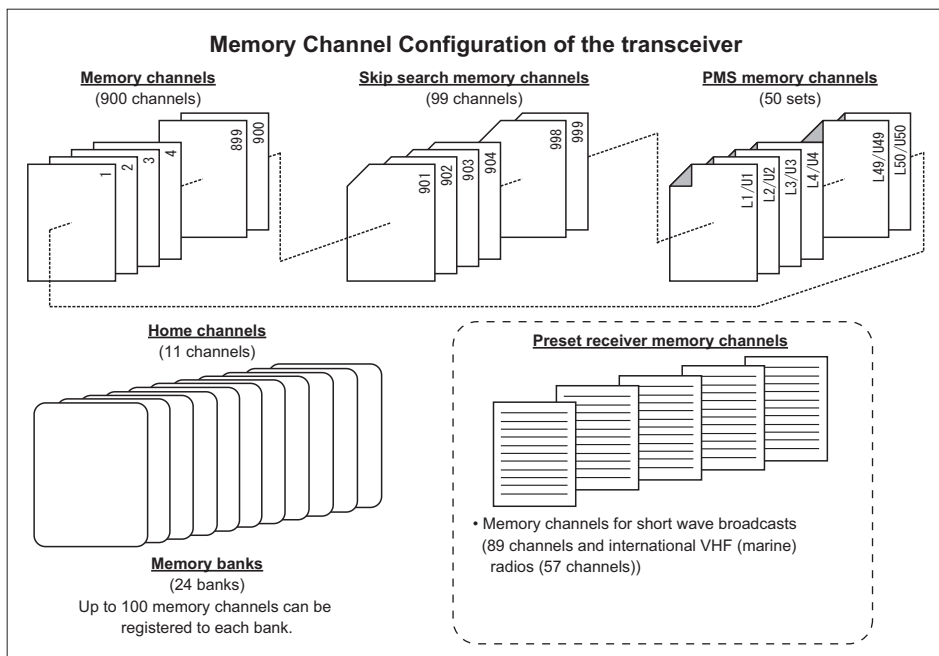



Registering to Memory Channel





Caution

The information such as operating frequency that is registered to memory channels can be corrupted due to wrong operation, static electricity, or electrical noise. Also, it can be erased in the case of a failure or repair. Be sure to write it down on paper or otherwise save the information (See pages 138 to 139).

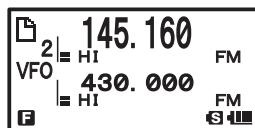
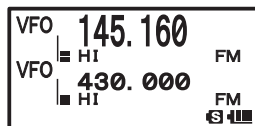
The transceiver allows you to use 900 memory channels (memory channel numbers 1 to 900).



- 1 Switch to the VFO mode.
- 2 Tune in to a frequency by turning .
Select the frequency you want to register to a memory channel.
- 3 Press and hold  over 1 second.
Enters the Memory Channel Registration mode, and the number of the memory channel next to the memory channel to which you registered a frequency last blinks.



- Remarks**
- To cancel the memory channel registration, press the  switch.
 - To register a frequency to a memory channel specified, Turn  to select the memory channel.
The  icon indicating [The specified memory channel is unregistered] lights, and the memory channel blinks.
The  icon indicating [The specified memory channel is registered] lights.
 - Pressing  each time skips memory channels quickly in steps of 100 memory channels.

- 4 Press  to complete the memory channel registration. The registered frequency appears on the LCD.
When registering a frequency to a memory channel already registered, "Overwrite OK?" appears on the LCD.

Tips





- By default, 144.000 MHz is registered to the memory channel 1. It can be changed to another frequency, but not be deleted.
- The frequency which has been registered to a memory channel can be overwritten with a new frequency. When you attempt to register a new frequency to a memory channel, an unregistered memory channel appears.
- To display the lowest unregistered memory number when you register a frequency to a memory channel, press and hold  over 1 second to enter the Set mode, and then select [3 MEMORY] → [6 MEMORY WRITE].
- To inhibit registration to all memory channels, press and hold  over 1 second to enter the Set mode, and then select [3 MEMORY] → [4 MEMORY PROTECT].

Split Memory

Two different frequencies, one for reception and other for transmission, can be registered to a memory channel.

- 1 Register a receive frequency to a memory channel.

Remark See "Registering to Memory Channel" above.

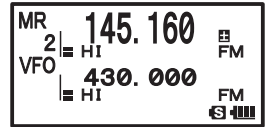

- 2 Select a transmit frequency in the VFO mode.
- 3 Press and hold  over 1 second.
- 4 Turn  to select the memory channel number that you registered the receive frequency to.
- 5 While pressing , press  to save the Split memory channel.

When you recall the memory channel to which you registered two different frequencies (one for receive and the other for transmit), the  appears on the LCD





Recalling a Memory Channel

Recall a registered memory channel using the following procedure:

- 1 Press  to enter the Memory mode and the memory channel you used last appears on the LCD.
- 2 Turn  to select the desired memory channel.
Select the memory channel to use.

Remarks • You can directly recall a memory channel using numeric keys.





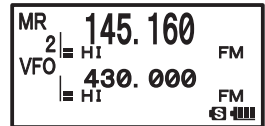

To recall memory channel 15: Press   

• Pressing  and turning  allows you to skip memory channels quickly in steps of 10 memory channels.

- 3 Press  to exit the Memory mode, and the frequency selected in the VFO mode appears.



Tips

- Unregistered memory channels are skipped.
- By default, a priority memory channel, which is used as dual receive priority memory channel, is set to the memory channel number 1. [P] appears on the upper right corner of the priority memory channel number (See page 75).
- The frequency registered to a memory channel can be transferred to the VFO operating band in the following procedure:
Press and hold  over 1 second. → Press  → "OVERWRITE OK?" appears → Press .
- To place the FT1DR/DE transceiver in the Memory Channel only mode, use the following procedure, which allows the use of memory channels only.
Press  while pressing  to turn on the transceiver.
To cancel the Memory Channel Only mode, press  while pressing  again.

Recalling Home Channel

- 1 Press  and then .

The home channel of the currently selected frequency band appears on the LCD.

- Tips**
- For the relationship between the frequency bands and the home channel frequencies, see the table on the next page.
 - Selecting a frequency by turning  allows you to return to the VFO mode.

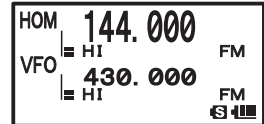

Frequency band	Frequency	Frequency band	Frequency
AM BC Band	540 kHz	174 to 222 MHz band	174.000 MHz
FM BC Band	76.000 (88.000) MHz	(INFO band (1))	222.000 MHz
(SW band)	1.800 MHz	430 MHz band	446.000 (430.000) MHz
50 MHz	50.000 MHz	470 to 770 MHz band	470.000 MHz
(AIR band)	108.000 MHz	Information radio band (2)	860.000 MHz
144 MHz band	146.520 (144.000) MHz	—	—

() : EXP/European version





Returning to the Previous Frequency

- 1 Press  and then .

The frequency used before recalling the home channel appears on the LCD.

•Changing Home Channel Frequency



You can change a default home channel frequency.

- 1 Switch to the VFO mode.
- 2 Turn  to select a frequency.
Select a frequency to change.
- 3 Press and hold  for over 1 second to enter the Write mode.
- 4 Press .
- 5 Press .

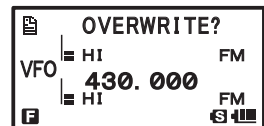
“OVERWRITE?” appears on the LCD for about 5 seconds.
When the home channel frequency has been overwritten by a new frequency, the home channel frequency of the selected frequency band is changed.



Deleting Memory Channel

- 1 Switch to the Memory mode.
- 2 Press and hold  for over 1 second.
- 3 Turn  to select the memory channel to delete.
- 4 Press .

“MASK?” appears on the LCD for about 3 seconds.

Remark To cancel the memory channel deletion operation, press .

- 5 Press .

Remark To delete other memory channels, repeat steps 2 through 5.

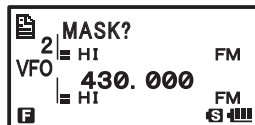
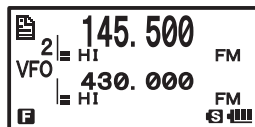

Caution



- Memory channel 1 cannot be deleted.

Tips

The memory channel specified as a priority memory channel cannot be deleted. To delete a priority memory channel, specify it as a regular memory channel, then delete it.

Restoring Deleted Memory Channel

You can restore a deleted memory channel.

- 1 Switch to the Memory mode.
The last used memory channel appears.
- 2 Press and hold  for over 1 second.
- 3 Turn  to select the memory channel to restore.
- 4 Press .

Using Memory Tag

Memory channels and home channels can be assigned a name (memory tag) such as a callsign or broadcast station name. A memory tag can be specified with up to 16 characters. The following types of characters can be entered:

- Alphabetic characters (uppercase and lowercase characters)
- Numeric characters (numbers)
- Symbols

Assigning a Name to a Memory Channel

Example: Assignment of name [YAESU]

- 1 Switch to the Memory mode.
- 2 Recall the memory channel to assign a name.
- 3 Press and hold **SET DISP** for over 1 second to enter the Set mode.
- 4 Turn **DIAL** to select [3 MEMORY].
- 5 Press **ENT**.
- 6 Turn **DIAL** to select [3 MEMORY NAME].
- 7 Press **ENT**.
The  cursor appears on the LCD.
- 8 Press **BCON TX 9 VP** 8 times to select the numeric character [Y].
- 9 Press **ENT** to move the cursor to the next character position.
- 10 Press **SCAN 2 ABC** 5 times to select the numeric character [A].
- 11 Press **ENT** to move the cursor to the next character position.
- 12 Press **P. RCVR 3 DEF** 6 times to select the numeric character [E].
- 13 Press **ENT** to move the cursor to the next character position.
- 14 Press **LOG 7 RS** 9 times to select the numeric character [S].
- 15 Press **ENT** to move the cursor to the next character position.
- 16 Press **8 TUV** 6 times to select the numeric character [U].
- 17 Press **PTT 6 69** to save the memory tag to the memory channel and exit the Set mode.

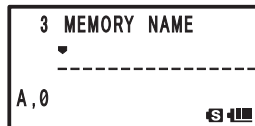
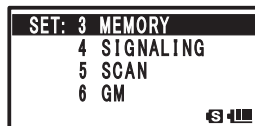

Tips

- To delete a character, press **MW**. The character is deleted and the cursor moves to left.
- Pressing **S LIST-APRS 0** while entering alphanumeric characters (A,0) allows you to select 0, (space), -, /, ?, !, ,, : and #
- When entering the same character repeatedly, press **ENT** to move the cursor.
- When assigning a name to a home channel, recall the target home channel by first executing step 1 (see above).

Displaying Memory Tag

During mono band operation, the tag (name) of the memory channel or home channel can be displayed using the following procedure:

- 1 Switch to the Memory mode.
- 2 Press and hold **MONO/DUAL A/B** for over 1 second.

The operating band is displayed in Mono band, and a tag (name) appears under the frequency.

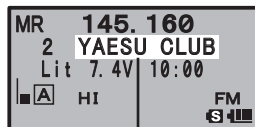

Tag (name) display

Using Memory Bank

Registered memory channels can be sorted according to the intended use. The transceiver allows you to use 24 types of memory banks. A maximum of 100 memory channels can be registered to each memory bank.

One memory channel can be registered in two or more memory banks. If the memory channel registered in any memory bank is changed or updated, the content of the corresponding memory channel in the other memory banks is automatically changed or updated.

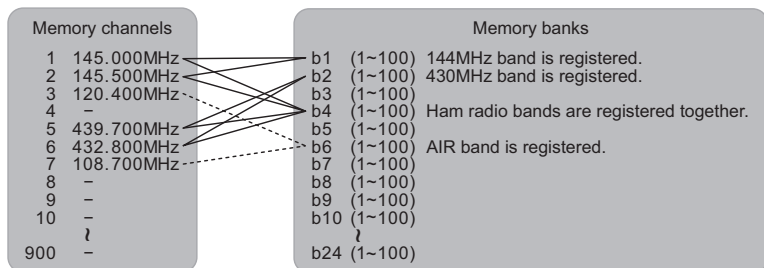

Registering a Memory Channel in a Memory Bank



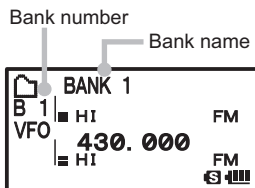
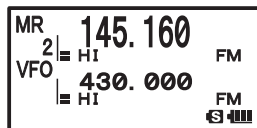



- 1 Switch to the Memory mode.
- 2 Turn to select a memory channel.
Select the memory channel to register in a memory bank.
- 3 Press and hold for over 1 second to enter the Memory Write mode.
- 4 Turn to select a memory bank number.
Select the number (B1 to B24) of the memory bank to register the memory channel.
- 5 Press to register the memory channel in the memory bank.



Tips

- See “Registering Your Favorite Preset Receiver Memory Channels in Memory Bank” on page 51.
- When selecting a memory bank using , the memory channel, skip search memory channel, and programmable memory channel appear on the LCD as well. They appear repeatedly on the LCD in the following order:
1 ⇄ 2 ⇄ 3 ⇄ ...L50 ⇄ U50 ⇄ BANK1 ⇄ BANK2 ⇄ ...BANK24 ⇄ 1 ⇄ 2...
- When the displayed number is close to [1], turning counterclockwise will display memory banks. When the displayed number is close to [U50], turning clockwise will display memory banks.
- Pressing displays memory banks quickly in steps of 100 memory channels. If the bank name was changed, the changed bank name appears.
- The icon appears for a memory bank in which no memory channel is registered, and the icon appears for a memory bank in which at least one memory channel is registered.



Recalling Memory Bank

- 1 Switch to the Memory mode.
- 2 Press  .
Pressing  each time toggles between the memory channel number and bank number.
- 3 Press  and then  .
- 4 Turn  to select a memory bank.
Select a memory bank.
- 5 Press  .
The memory bank to be used is determined.
- 6 Turn  to select a memory channel.
Select a memory channel in the memory bank.

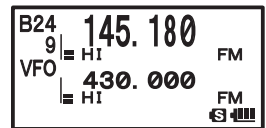
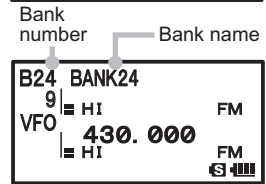
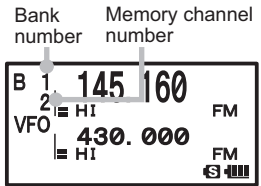
- Remarks**
- To select another memory bank, repeat steps 3 through 5.
 - To return to the Regular Memory Channel mode, press  .



Canceling Memory Channel Registration in Memory Bank

- 1 Recall the memory bank in which the memory channel registration is to be deleted.
See "Recalling Memory Bank" above.
- 2 Turn  to select a memory channel that is to be canceled from the Memory bank.
- 3 Press and hold  over 1 second, and then press  .
Registration of memory channel in the memory bank is cancelled, returning to the memory bank display state. If no other memory channel is registered in the memory bank, the memory bank having the lowest bank number appears.



Assigning Name to Memory Bank

A memory bank can be specified with up to 16 characters.

The following types of characters can be entered:





















- Alphabetic characters (uppercase and lowercase characters)
- Numeric characters (numbers)
- Symbols

Example: 144Mz band

- 1 Press and hold  for over 1 second to enter the Set mode.
- 2 Turn  to select [3 MEMORY].
- 3 Press  .



Using Memory Bank

- 4 Turn  to select [2 BANK NAME].
- 5 Press .
- 6 Turn  to select a memory bank.
Select the number of the memory bank to which you want to assign a name.
- 7 Press  to move the cursor to the first character of the bank name.
- 8 Press   to select the numeric character [1].
- 9 Press  to move the cursor to the next character position.
- 10 Press  7 times to select the numeric character [4].
Pressing  allows you to select the following characters sequentially:
G → H → I → g → h → i → 4 → G
- 11 Press  to move the cursor to the next character position.
- 12 Press the   key 7 times to select the numeric character [4].
Pressing the   key allows you to select the following characters sequentially:
G → H → I → g → h → i → 4 → G
- 13 Press  to move the cursor to the next character position.
- 14 Press   to select [M].
Pressing   allows you to select the following characters sequentially:
M → N → O → m → n → o → 6 → M
- 15 Press  to move the cursor to the next character position.
- 16 Select [H].
- 17 Press [9] 8 times.
Select [z].
- 18 Press  to save the name of memory bank and exit the Set mode.





Bank number



Change the bank name.
Enter a name (First digit)



Tips

- To delete a character, press . A character is deleted and the cursor moves to left.
- Pressing  while entering alphanumeric characters (A,0) allows you to select 0, (space), -, /, ?, !, ,, : and #
- When entering the same type of characters repeatedly, press  to move the cursor.

Convenient Preset Receiver Memory Channels

Frequencies of SP1 Weather Broadcast (10 channels). SP2 International VHF (marine) radio (57 channels) and SP3 Shortwave Broadcasts (89 channels) are preset in the preset receiver memory channels. These channels can be selected in advance from region to region.

- **VHF Weather Broadcast Station preset receiver memory channels**

[SP1 WX CH]Page 52

The frequencies (10 channel) used for the VHF Weather Broadcast Station are registered to the dedicated preset receiver memory channels.

- **International VHF (marine) radio preset receiver memory channels**

[SP2 INTVHF]Page 53

The frequencies (57 channel) used for the international VHF (marine) radio are registered to the dedicated preset receiver memory channels.

- **World broadcast preset receiver memory channels**

[SP3 SW]Page 54

You can listen to major broadcasts from around the world (total 89 channels).

Registering Your Favorite Preset Receiver Memory Channels in Memory Bank

You can register your favorite preset receiver memory channel in a memory bank.

1 Turn  to select your favorite preset receiver memory channel.

2 Press and hold  for over 1 second to enter the Memory Bank Write mode.

The **F** blinks on the LCD.

Remark To cancel registration, press .

3 Turn  to select the memory bank in which you want to register your favorite preset receiver memory channel.

4 Press the  to register the preset receiver memory channel in the memory bank, and the frequency appears on the LCD.

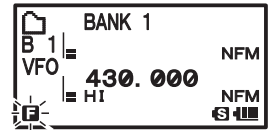

Recalling Preset Receiver Memory Channel to Listen to the Weather Broadcast

1 Press  to set A-band to the operating band.

2 Press  and then  to enter the Preset Receiver mode.

3 Press .

Select [SP1 WX CH].

4 Turn  to select a preset Weather Broadcast receiver memory channel to listen to.

Remark To stop reception of the Weather Broadcast, press .

Convenient Preset Receiver Memory Channels

Recalling Preset Receiver Memory Channel to Listen to the International VHF (Marine) Radio

The frequencies (57 channels) used for the international VHF (marine) radio are registered to the dedicated preset receiver memory channels.

- 1 Press to set A-band to the operating band.
- 2 Press and then to enter the Preset Receiver mode.
- 3 Press . Select [SP2 INTVHF].
- 4 Turn to select a preset VHF receiver memory channel to listen to.

Remark To stop reception of the international VHF radio, press .

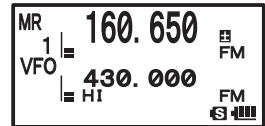

In the event of extreme weather disturbances, such as storms and hurricanes, the NOAA (National Oceanic and Atmospheric Administration) sends a weather alert accompanied by a 1050 Hz tone and subsequent weather report on one of the NOAA weather channels. You may enable the Weather Alert tone via Set Mode option [4 SIGNALING] → [14 WX ALERT], if desired (See page 124).

Tips

- The preset receiver memory channel cannot be rewritten with the data of another frequency.
- To scan the preset receiver memory channels toward higher channel numbers, press and then . Turning one click counterclockwise scans the preset receiver memory channels toward lower channel numbers. If a signal is received during scanning, the scanning is suspended for 5 seconds.
- The operation that is performed when scanning stops can be set by following the procedure described in "Selecting a Reception Method When Scanning Stops" on page 59.

WX Channel Frequency List

CH	Frequency	CH	Frequency
1	162.550 MHz	6	162.500 MHz
2	162.400 MHz	7	162.525 MHz
3	162.475 MHz	8	161.650 MHz
4	162.425 MHz	9	161.775 MHz
5	162.450 MHz	10	163.275 MHz







Convenient Preset Receiver Memory Channels

Frequencies of International VHF (Marine) Radio registered to the preset receiver memory channels

Memory channel No.	Frequency (MHz)		Memory channel No.	Frequency (MHz)	
1	156.050	160.650*	15	156.750	
2	156.100	160.700*	16	156.800	
3	156.150	160.750*	17	156.850	
4	156.200	160.800*	18	156.900	161.500*
5	156.250	160.850*	19	156.950	161.550*
6	156.300		20	157.000	161.600*
7	156.350	160.950*	21	157.050	161.650*
8	156.400		22	157.100	161.700*
9	156.450		23	157.150	161.750*
10	156.500		24	157.200	161.800*
11	156.550		25	157.250	161.850*
12	156.600		26	157.300	161.900*
13	156.650		27	157.350	161.950*
14	156.700		28	157.400	162.000*

Memory No.	Frequency (MHz)		Memory No.	Frequency (MHz)	
60	156.025	160.625*	74	156.725	
61	156.075	160.675*	75	156.775	
62	156.125	160.725*	76	156.825	
63	156.175	160.775*	77	156.875	
64	156.225	160.825*	78	156.955	161.550*
65	156.275	160.875*	79	156.975	161.575*
66	156.325	160.925*	80	157.025	161.625*
67	156.375		81	157.075	161.675*
68	156.425		82	157.125	161.725*
69	156.475		83	157.175	161.775*
70	156.525		84	157.225	161.825*
71	156.575		85	157.275	161.875*
72	156.625		86	157.325	161.925*
73	156.675		87	157.375	161.975*
—	—		88	157.425	162.025*





Remark

* indicates the frequency of the VHF Marine base station. For example, if the preset receiver memory channel 1 is selected, the base station frequency 160.650 MHz appears and  lights. Pressing  and then  displays the Ship Station frequency 160.650 MHz and  lights. The base station frequency minus 4.6 MHz equals the Ship Station frequency, and duplex operation starts. To return to the base station frequency, press  and then .

Convenient Preset Receiver Memory Channels

Recalling Preset Receiver Memory Channel to Listen to the World Broadcast

The frequencies (89 channels) used for the world broadcast are registered to the dedicated preset receiver memory channels.

- 1 Press  to set A-band to the operating band.
- 2 Press  and then  to enter the Preset Receiver mode.
- 3 Press .
Select [SP3 SW].
- 4 Turn  to select a preset world Broadcast receiver memory channel to listen to.

Remark To stop reception of the world broadcast, press .

- Depending on time zone or signal strength, Broadcasts may not be received.
- There are broadcast station other than those listed below that can be received. In addition, depending on the broadcast station, the frequency may be changed, off-air, or have become abolished. For details, please refer to a commercially sold frequencies list.

Worldwide short wave broadcast

CH Number	Frequency (MHz)	Name	Broadcast Station Name	CH Number	Frequency (MHz)	Name	Broadcast Station Name
1	6.030	VOA	USA	25	7.170	TURKEY	Turkey
2	6.160	VOA	USA	26	7.270	TURKEY	Turkey
3	9.760	VOA	USA	27	9.560	TURKEY	Turkey
4	11.965	VOA	USA	28	11.690	TURKEY	Turkey
5	9.555	CANADA	Canada	29	9.660	VATICAN	Vatican
6	9.660	CANADA	Canada	30	11.625	VATICAN	Vatican
7	11.715	CANADA	Canada	31	11.830	VATICAN	Vatican
8	11.955	CANADA	Canada	32	15.235	VATICAN	Vatican
9	6.195	BBC	UK	33	5.955	NEDRLAND	Netherlands
10	9.410	BBC	UK	34	6.020	NEDRLAND	Netherlands
11	12.095	BBC	UK	35	9.895	NEDRLAND	Netherlands
12	15.310	BBC	UK	36	11.655	NEDRLAND	Netherlands
13	6.090	FRANCE	France	37	5.985	CZECH	Czech Republic
14	9.790	FRANCE	France	38	6.105	CZECH	Czech Republic
15	11.670	FRANCE	France	39	9.455	CZECH	Czech Republic
16	15.195	FRANCE	France	40	11.860	CZECH	Czech Republic
17	6.000	DW	Germany	41	9.780	PORTUGAL	Portugal
18	6.075	DW	Germany	42	11.630	PORTUGAL	Portugal
19	9.650	DW	Germany	43	15.550	PORTUGAL	Portugal
20	9.735	DW	Germany	44	21.655	PORTUGAL	Portugal
21	5.990	ITALY	Italy	45	9.650	SPAIN	Spain
22	9.575	ITALY	Italy	46	11.880	SPAIN	Spain
23	9.675	ITALY	Italy	47	11.910	SPAIN	Spain
24	17.780	ITALY	Italy	48	15.290	SPAIN	Spain

Convenient Preset Receiver Memory Channels

CH Number	Frequency (MHz)	Name	Broadcast Station Name	CH Number	Frequency (MHz)	Name	Broadcast Station Name
49	6.055	NIKKEI	Japan (Nikkei)	71	9.595	INDIA	India
50	7.315	NORWAY	Norway	72	11.620	INDIA	India
51	9.590	NORWAY	Norway	73	15.020	INDIA	India
52	9.925	NORWAY	Norway	74	7.190	CHINA	China
53	9.985	NORWAY	Norway	75	7.405	CHINA	China
54	6.065	SWEDEN	Sweden	76	9.785	CHINA	China
55	9.490	SWEDEN	Sweden	77	11.685	CHINA	China
56	15.240	SWEDEN	Sweden	78	6.135	KOREA	South Korea
57	17.505	SWEDEN	Sweden	79	7.275	KOREA	South Korea
58	6.120	FINLAND	Finland	80	9.570	KOREA	South Korea
59	9.560	FINLAND	Finland	81	13.670	KOREA	South Korea
60	11.755	FINLAND	Finland	82	6.165	JAPAN	Japan
61	15.400	FINLAND	Finland	83	7.200	JAPAN	Japan
62	5.920	RUSSIA	Russia	84	9.750	JAPAN	Japan
63	5.940	RUSSIA	Russia	85	11.860	JAPAN	Japan
64	7.200	RUSSIA	Russia	86	5.995	AUSTRALI	Australia
65	12.030	RUSSIA	Russia	87	9.580	AUSTRALI	Australia
66	7.465	ISRAEL	Israel	88	9.660	AUSTRALI	Australia
67	11.585	ISRAEL	Israel	89	12.080	AUSTRALI	Australia
68	15.615	ISRAEL	Israel				
69	17.535	ISRAEL	Israel				
70	6.045	INDIA	India				



Reception Mode: AM

Using the Scanning Function

The FT1DR/DE supports the following four scan modes:

- (1) VFO Scan
- (2) Memory Channel Scan
- (3) Programmable Memory Channel Scan
- (4) Selected Memory Channel Scan

VFO Scan

- 1 Switch to the VFO mode, and then select a band to scan.
- 2 Press  and then  to start scanning (SCAN) toward higher frequencies.

Tips When a signal is received during scanning, the decimal point blinks.

Turn  clockwise: Scanning is performed toward higher frequencies.

Turn  counterclockwise: Scanning is performed toward lower frequencies.

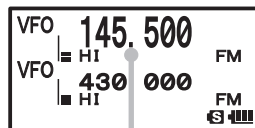

When a signal is received, the decimal point blinks.





When a signal is received during scanning, a beep is emitted and its frequency appears for 5 seconds. When scanning is suspended, the decimal point blinks and the LCD stays lit. After receiving the signal for 5 seconds, scanning resumes.

The range for scanning can be selected by selecting the Set mode options [5 SCAN WIDTH] and then [5 SCAN] .

Canceling Scanning

To cancel scanning, press .

Tips

- Even during scanning, you can adjust the squelch in the following procedure:
Press  → Press  → Turn  to adjust the squelch.
- During scanning, you can save the squelch adjustment in the following procedure:
Press  → Press .

A-band and B-band reception frequencies

A-band	B-band
0.5 MHz to 1.8 MHz (AM BC Band)	--
76 (88) MHz to 108 MHz (FM BC Band)	--
1.8 MHz to 30 MHz (SW band)	--
30 MHz to 76 (88) MHz (50 MHz band)	--
108 MHz to 137 MHz (AIR band)	108 MHz to 137 MHz (AIR band)
137 MHz to 174 MHz (144 MHz band)	137 MHz to 174 MHz (144 MHz band)
174 MHz to 222 MHz (VHF-TV Band)	174 MHz to 222 MHz (VHF-TV Band)
222 MHz to 420 MHz (INFO band (1))	222 MHz to 420 MHz (INFO band (1))
420 MHz to 470 MHz (430 MHz band)	420 MHz to 470 MHz (430 MHz band)
470 MHz to 774 (800) MHz (UHF-TV Band)	470 MHz to 580 MHz
803 (800) MHz to 999.9 MHz Cellular Blocked USA version	--







(): EXP/European version

- For the operation to perform when scanning stops, see “Selecting a Reception Method When Scanning Stops” on page 59.
- Press and hold  over 1 second to select the Set mode option, and then select the following setting items for more convenient use:
[8 CONFIG] → [3 BEEP] → [EDGE]: Emits a beep when the frequency band edge is reached.
[8 CONFIG] → [3 BEEP] → [SELECT]: Prevents a beep from being emitted when scanning stops.
[5 SCAN] → [2 SCAN LAMP]: Prevents the LCD from being lit when scanning stops.

Skipping a Frequency You Do Not Want to Scan (Skip Search Memory)



Scanning may stop at a frequency that you do not want to receive. Such a frequency can be skipped by registering it to the [skip search memory channels]. Up to 99 frequencies can be saved in the skip search memory channels (memory channels 901 to 999).

Specifying the Frequency You Do Not Want to Scan

- 1 Start VFO scanning.
Start VFO scanning with reference to [VFO Scanning] on page 56.
- 2 When scanning stops at a frequency you do not want to receive, press and hold  for over 1 second.
The number of the next unregistered skip search memory channel will blink.
Tips Turning  allows you to specify other skip search memory channels.
- 3 Press  to save (register) the frequency to the skip search memory channel, and resume scanning.
Tips
 - You can register a frequency you do not want to receive to a skip search memory channel by using the following procedure in advance:
 - 1 In the VFO mode, tune in to the frequency you do not want to scan.
 - 2 Press and hold  for over 1 second.
 - 3 Turn  to select a skip search memory channel.
 - 4 Press  to save (register) the frequency to the skip search memory channel.
 - To stop scanning, press .



Deleting a Frequency Registered to the Skip Search Memory Channel

The frequency registered to the skip search memory channel can be deleted in the following procedure. After it is deleted the frequency is scanned.

- 1 Switch to the Memory mode.
- 2 Press and hold  for over 1 second.
- 3 Turn  to select a skip search memory channel from which you wish to delete the registered frequency.

Select the skip search memory channel (901-999) from which the registered frequency is to be deleted.

When selecting a skip search memory channel number, pressing  allows you to skip memory channel numbers in steps of 100 memory channel numbers.

- 4 Press .
- [DELETE OK?] appears on the LCD.
- 5 Press  to delete the registered frequency from the skip search memory channel.
- Tip** To delete another frequency from the skip search memory channel, repeat steps 2 through 4.

Tips

- Restoring the Frequency Deleted from the Skip Search Memory Channel
If you have not specified a new frequency for the same memory channel, you can restore the deleted frequency by repeating steps 1 through 4.

Selecting a Reception Method When Scanning Stops

When scanning stops, you can select one of the following three reception methods:

- (1) The signal is received for the specified period of time, and then scanning resumes. You can specify this period of time in steps of 0.5 second within the range from 2 to 10 seconds.
- (2) The signal is received until it fades out. Two seconds after the signal fades out, scanning resumes. [BUSY] appears on the LCD.
- (3) Scanning stops and the current frequency is received. [HOLD] appears on the LCD.

- 1 Press and hold **SET** **DISP** for over 1 second.
- 2 Turn **DIAL** to select [5 SCAN].
- 3 Press **ENT**.
- 4 Turn **DIAL** to select [4 SCAN RESUME].
- 5 Press **ENT**.
- 6 Press **ENT** again.
- 7 Turn **DIAL** to specify the reception method.
Select a reception method from [2 SEC TO 10 SEC (0.5 SEC STEP)], [BUSY], and [HOLD].
- 8 Press **PTT** to save the specified reception method and exit from the Set mode.

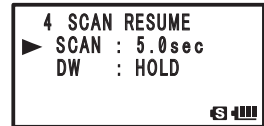
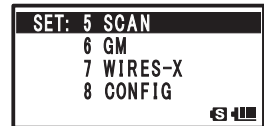

Tips

- The reception method selected here is also applied to [VFO Scanning], [Programmable Memory Channel Scanning] and [Memory Channel Scanning].
- The scanning restart time after BUSY (duration of signal reception) can be changed by selecting the Set mode option [5 SCAN RESTART] → [3 SCAN RE-START].

Memory Channel Scanning

Frequencies registered to the memory channels can be scanned in the order of memory channel number.

- 1 Switch to the Memory mode and recall a memory channel.
- 2 Press **MW** and then **SCAN** **(ZABC)**.

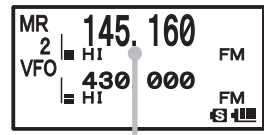

Scanning (SCAN) is performed toward higher memory channel numbers.

When a signal is received, the decimal point blinks.









When a signal is received, the decimal point blinks.

Using the Scanning Function

- Tips**
- Turn  clockwise.: Scanning is performed toward higher memory channel numbers.
 - Turn  counterclockwise: Scanning is performed toward lower memory channel numbers.
 - When a signal is received during scanning, scanning stops for 5 seconds and this frequency is received.
 - When scanning is suspended, the decimal point blinks and the LCD stays lit.
 - After receiving the frequency for 5 seconds, scanning resumes.
 - To stop scanning, press .

Tips







- Even during scanning, you can adjust the squelch in the following procedure:
Press  → Press  → Turn  to adjust the squelch.
- During scanning, you can finish the squelch adjustment in the following procedure:
Press  → Press .
- When a memory channel is recalled, the regular memory channels (memory channel numbers 1-900) are scanned.
- When a memory bank is recalled, only the memory channels in the memory bank are scanned.
- For the operation to perform when scanning stops, see [Selecting a Reception Method When Scanning Stops] on page 59.
- Press and hold  over 1 second to select the Set mode option, and then select the following setting items for more convenient use:
[8 CONFIG] → [3 BEEP] → [EDGE]: Emits a beep when the frequency band edge is reached.
[8 CONFIG] → [3 BEEP] → [SELECT]: Prevents a beep from being emitted when scanning stops.
[5 SCAN] → [2 SCAN LAMP]: Prevents the LCD from being lit when scanning stops.
[5 SCAN WIDTH] → [5 SCAN]: Range for scanning can be selected.

Specifying a Skip/Selected Memory Channel

You can specify two types of memory channels, a skip memory channel and a selected memory channel, for effective memory channel scanning.

Skip memory channel: You can specify a memory channel that need not be scanned during memory channel scanning.

Selected memory channel: You can specify selected memory channels so that only the specific memory channels are scanned during memory scanning.

- 1 Switch to the Memory mode, and then recall the memory channel you want to specify as a skip memory channel or a selected memory channel.
- 2 Press and hold  over 1 second.
Enters the Set mode.
- 3 Turn  to select [3 MEMORY].
- 4 Press .
- 5 Turn  to select [5 MEMORY SKIP].
- 6 Press .
- 7 Turn  to select [OFF], [SKIP], or [SELECT].
- 8 Press  to save the setting and exit from the Set mode.

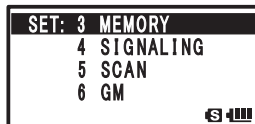

Tips To cancel a skip/selected memory channel, select [OFF].
When it is canceled, the ◀ icon on the LCD disappears.

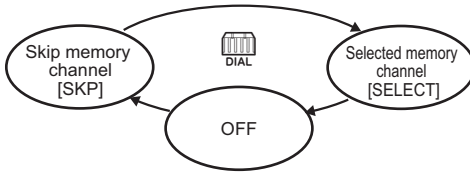

Lights when a skip memory channel is specified



Blinks when a select memory channel is specified

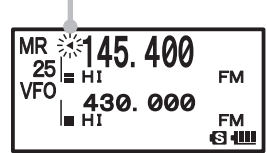

Scanning Only the Selected Memory Channel

- 1 Switch to the Memory mode, and then recall the selected memory channel.
- 2 Press and then .

- Tips**
- Scanning (SCAN) is performed toward higher memory channel numbers.
 - Only the selected memory channel is scanned.
 - If a signal is received during scanning, a beep is emitted and scanning stops for 5 seconds to receive the current frequency.
 - When scanning is suspended, the decimal point blinks and the LCD stays lit.
 - After receiving the frequency for 5 seconds, scanning resumes.
 - To cancel scanning, press .
 - You can select the range for scanning by selecting [5 SCAN] → [5 SCAN WIDTH] in the Set mode.



Scanning a Memory Bank

Only the memory channels in the recalled memory bank can be scanned.



- 1 Press to enter the Memory mode.
- 2 Press to enter Recall a memory bank.

Pressing each time toggles between [MEMORY NO] and [BANK (No.)].

Tips To recall another memory bank, press and then .





- 3 Turn to select a memory bank.
Select a memory bank from BANK1 through BANK 24.
- 4 Press .
The selected memory bank is determined.
- 5 Press and then .
Scanning (SCAN) is performed toward higher memory channel numbers.

Using the Scanning Function

- Tips**
- Turn  clockwise: Scanning is performed toward higher memory channel numbers.
 - Turn  counterclockwise: Scanning is performed toward lower memory channel numbers.
 - When a signal is received during scanning, scanning stops for 5 seconds and this frequency is received.
 - When scanning is suspended, the decimal point blinks and the LCD stays lit.
 - After receiving the frequency for 5 seconds, scanning resumes.
 - To stop scanning, press .
 - You can select the range for scanning by selecting [5 SCAN] → [5 SCAN WIDTH] in the Set mode.

Memory Bank Link Scan

During regular memory bank scanning, only the memory channels assigned to the recalled memory bank are scanned. During memory bank link scanning, memory channels registered in two or more previously specified banks can be scanned.

- 1 Press  to enter the Memory mode.
- 2 Press  to enter Recall a memory bank.
- 3 Press  and then .
- 4 Turn  to select a memory bank.

Select a memory bank subject to memory bank link scanning.



- 5 Press  to select a Memory bank link.
The memory bank number changes from [B] to [b], indicating that the bank link has been activated

- 6 Repeat steps 4 to 5 to select another memory bank.

- 7 Press .
- The memory banks subject to memory bank link scanning are determined.

- 8 Press  and then [2].

Scanning (SCAN) is performed toward higher memory channel numbers.



- Tips**
- Turn  clockwise.: Scanning is performed toward higher memory channel numbers.
 - Turn  counterclockwise: Scanning is performed toward lower memory channel numbers.
 - When a signal is received during scanning, scanning stops for 5 seconds and this frequency is received.
 - When scanning is suspended, the decimal point blinks and the LCD stays lit.
 - After receiving the frequency for 5 seconds, scanning resumes.
 - To stop scanning, press .
 - You can select the range for scanning by selecting [5 SCAN] → [5 SCAN WIDTH] in the Set mode.

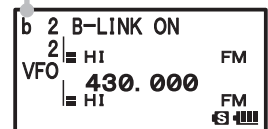

The memory bank number changes from [B] to [b].



•Canceling Bank Link Scanning

- 1 Press  and then .
- 2 Recall the memory bank for which bank link scanning was specified.
- 3 Press .

The memory bank number changes from [b] to [B], indicating that the bank link has been deactivated.

Programmable Memory Channel Scan (PMS)

Registering to a Programmable Memory Channel

50 sets of PMS memory channels (L1/U1 to L50/U50) are available.

Specify the lower limit frequency of the frequency range you want to scan for memory channel [L*], and the upper limit frequency for [U*].

Enter a number between 1 and 50 for *. Use the same number for the lower and upper limit memory channels.

Specify the lower limit frequency and upper limit frequency for the PMS memory channel (See page 43).

PMS memory channels are located next to the last memory channel.

Pressing  scans PMS memory channels quickly in steps of 100 memory channels.

Example: When registering the lower limit frequency 145.160 MHz and the upper limit frequency 145.460 MHz to a PMS memory channel.

Lower limit frequency L1

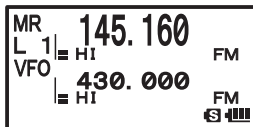

Upper limit frequency U1

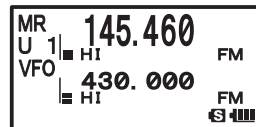

Caution

When the upper and lower limit frequencies have been set in different step, be sure to set 100 kHz or more in between.

Performing Programmable Memory Channel Scan

The programmable memory channel scan allows you to scan a specified frequency range within the same frequency band.

1 Switch to the Memory mode.

Recall a PMS memory channel to which the lower limit frequency or upper limit frequency is registered.

2 Press and then .

Programmable memory channel scanning starts.

Tips • Turn  clockwise: Scanning is performed toward higher frequencies.





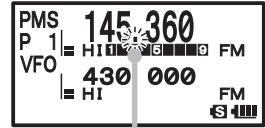
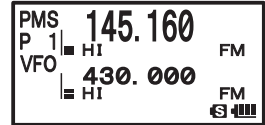

Turn  counterclockwise: Scanning is performed toward lower frequencies.

- When a signal is received during scanning, scanning stops for 5 seconds and this frequency is received.
- When scanning is suspended, the decimal point blinks and the LCD stays lit.
- After receiving the frequency for 5 seconds, scanning resumes.
- To stop scanning, press .



Decimal point blinks.

Tips

- When a skip memory channel is specified for [L*] or [U*] or when the lower/upper limit frequency is not properly specified, program memory channel scanning is not performed properly.
- Press and hold  over 1 second to select the Set mode option and then select the following setting items for more convenient use:
 [8 CONFIG] → [3 BEEP] → [EDGE]: Emits a beep when the frequency band edge is reached.
 [5 SCAN] → [2 SCAN LAMP]: Prevents the LCD from being lit when scanning stops.
- Even during scanning, you can adjust the squelch in the following procedure:
 Press  → Press  → Turn  to adjust the squelch.
- During scanning, you can finish the squelch adjustment in the following procedure:
 Press  → Press .

Using the Digital GM Function

(Digital Group Monitor Function)

What is the GM function?

The Digital GM (Group Monitor) Function automatically checks if there is another transceiver operating on the same frequency with the GM function within transmission range, and displays the direction, distance and other information for each detected callsign on the LCD. This convenient function not only lets you know if a friend is within transmission range, but also enables instant confirmation of position information between group members. Furthermore, by using this function, you can send messages and images between group members.

Caution

The GM function does not function in the analog mode. Using the  key, switch the communication mode to AMS (Auto Mode Select Function) or digital mode.

Tip

When transmitting image data while GM function is active, the transmission mode automatically switches to FR mode (High Speed Data Communication Mode). The transmission mode will automatically return to the previous V/D mode (Voice/Data Simultaneous Communication Mode).



Standard Operation of the GM Function

Using the GM Function

There are 2 ways of using the Digital GM Function.

- (1) Show all stations (up to 24 stations) operating with the GM function.
- (2) Register IDs of friends in a group and use it only between registered members.

•Displaying all stations (up to 24 stations) operating with the GM function.

- 1 Adjust frequency to A band.
- 2 Press  to open the group list.
- 3 Turn  to select [ALL].
- 4 Press .

The ID, distance, and direction of all stations (up to 24) within communication range operating with the GM function on the same frequency are displayed.

If there are more than 3 stations, turn  to scroll through the display.

When the GM function is active, not only can you verify if a station is in or out of communication range but the position (direction and distance) information as well.

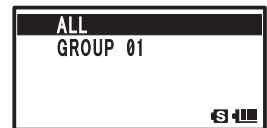

Group List Screen

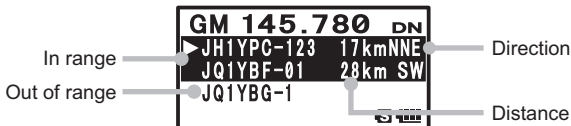

Example of display when ALL is selected

Standard Operation of the GM Function

- **Registering IDs of friends in a group and using GM function only between registered members**

Set a group with a name such as [Touring] or [Camp], and only show members registered to that group.



Example of display when Group is set

For group setting and instruction on how to register members to a group, refer to the GM function instruction manual (please download it from our company website).

- **Turning the GPS Function OFF**

Press **GM**.

The GM function is deactivated and the transceiver returns to the state previous to when GM function was activated.

Tip

With the GM function, data such as messages and images can be transmitted between members.
For details, refer to the GM function instruction manual (please download it from our company website).

What is the APRS (Automatic Packet Reporting System)?

Although there are several functions that display position information using GPS in amateur radios, the APRS is data communication system that transmits data such as position information and messages using a format proposed by Bob Bruninga of WB4APR.

Upon receiving an APRS signal from the remote station, information such as direction and distance to the remote station from your station and speed of the remote station appear on the LCD of your transceiver.

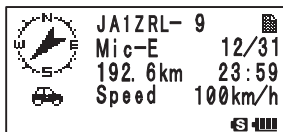

Example of display when APRS signal is received

The settings (initial settings) such as callsign and symbol for your station must be applied before using the APRS function.

For details, refer to the APRS function instruction manual (please download it from our company website).

Using the GPS Function

What is GPS?

GPS (Global Positioning System) is a space-based satellite navigation system that provides location and time information anywhere on the earth. It was developed by the U.S. Department of Defense as a military system. It receives signals from three or more of about 30 GPS satellites flying at an altitude of about 20,000 km, and displays the current position (latitude, longitude, and altitude) within a tolerance of several meters. In addition, GPS can receive the exact time from the satellite's onboard atomic clock.







Activating the GPS Function

To activate the GPS function, select [9 APROS] → [23GPS POWER], and then select [GPS ON] in the Set mode.

Tips

- Default: ON

When the GPS function on the transceiver is turned ON, internal clock settings and position settings for your station are automatically obtained from the GPS data.

- 1 Press and hold  for over 1 second to enter the Set mode.
- 2 Turn  to select [9 APRS].
- 3 Press .
- 4 Turn  to select [20 GPS POWER].
- 5 Press .
- 6 Turn  to select [GPS ON].
- 7 Press  to set the GPS Function to ON, and exit the Set mode.

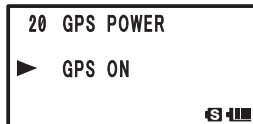
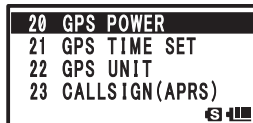
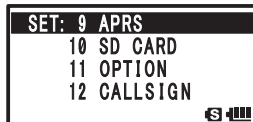

Tips

- Tip Information about the current positions of radio stations provided by GPS can be registered to 10 memory channels (P1 to P10). Registered position information can be used to set the position of your station.
- When the GPS function is active, the power consumption increases by about 40 mA. As a result, the battery life is reduced by about 20% compared to when the GPS function is deactivated.
- To use the GPS function during APRS operation, be sure to select [9 APRS] → [24MY POSITION], and then select [GPS] in the Set mode.

Method of Positioning by GPS

Displaying Current Position Information of Your Station

- 1 Turn on the transceiver.
- 2 Press and hold **SET** (**DISP**) for over 1 second to enter the Set mode.
- 3 Turn **DIAL** to select [1 DISPLAY].
- 4 Press **ENT**.
- 5 Turn **DIAL** to select [1 GPS POWER].
- 6 Press **ENT**.
- 7 GPS data appears on the LCD.

An arrow icon (the direction in which you are heading), your current position, number of satellites, longitude, latitude, and altitude appear on the LCD.

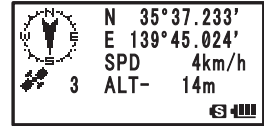

Tips

- The arrow icon (the direction in which you are heading) will not appear and the latitude/altitude blinks until GPS satellite data is acquired.
- When GPS satellite data has been acquired, the arrow icon (the direction in which you are heading) will appear, the latitude/altitude will change from blinking to lit, and your current position will be displayed.
- If acquisition of GPS satellite data is interrupted due to an obstacle, such as a building or tunnel, only the arrow icon (the direction in which you are heading) disappears.

- 8 Press **DIAL** to scroll the screen, and display the current time. Pressing **DIAL** again displays GPS data. The GPS screens will transition each time **ENT** is pressed.

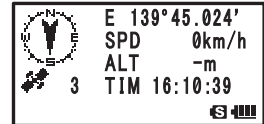

9. Press **PTT**.

The screen returns from the GPS screen to the normal frequency display. (Not return to the transmission state)

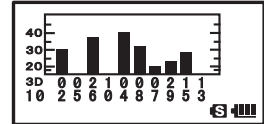

Displaying Position Information of Remote Station in Digital Mode

With the V/D mode C4FM digital, because GPS position information is transmitted simultaneously with voice signals, the direction and position of the remote station can be displayed in real-time even while communicating.

For details, see “Real-Time Navigation Function” on page 73.

Tip

- Even if the GPS function of your station is set to OFF, position information of the remote station can be displayed in V/D mode.

Caution

- If the GPS function is not active, the remote station will not be able to acquire position information for your station.

About Positioning by GPS

“Positioning” refers to calculation of your current position from the satellite orbit information and radio propagation time. At least three satellites need to be acquired for successful positioning. If positioning fails, move away from buildings as far as possible and stand in an area with open sky.

● About errors

A positioning error by several hundred meters can occur due to the environmental conditions. Under favorable conditions, positioning can be performed successfully using only three satellites. However, under the following poor conditions, the positioning accuracy can decrease or positioning can fail.

- Between tall buildings
- Narrow paths between buildings
- Indoors or in close vicinity to large buildings
- Beneath bridges or high-voltage lines
- Between trees such as in forests or woods
- Inside tunnel or underground
- Usage behind heat reflective glass
- Areas with strong magnetic fields.

● Searching for satellites when using the GPS function for the first time each day







When you use the GPS function for the first time after purchase or the first time in the day, a few minutes are required to search for satellites. Also, when using the GPS function after turning off the transceiver for several hours, a few minutes may be required to search for satellites.

Saving GPS Information (GPS Log Function)

Position information from the GPS can be saved periodically to the microSD memory card.

Using the saved data and a personal computer, tracks can be displayed with commercially sold map software*.

* Map software, and methods of use are not supported by YAESU.

- 1 Check that the GPS function is active.
If it is not active, refer to page 68 and enable the GPS function.
- 2 Press  for over 1 second.
- 3 Turn  to select [8 CONFIG].
- 4 Press .
- 5 Turn  to select [6 GPS LOG].
- 6 Press .
- 7 Turn  to select the interval for saving data.
OFF / 1 sec / 2 sec / 5 sec / 10 sec / 30 sec / 60 sec
Position information is not saved if OFF is selected.
- 8 Press  to enable the GPS log function and exit from the Set mode.

Tip

- Position information will continue to be saved unless “OFF” is selected in step 7, shown above, or the power of the transceiver is turned off.
- If “ON” is selected again in step 7, shown above, or the power for the transceiver is turned on, position information will start being saved to a differently named file.

Checking Tracks on a PC

- 1 Turn the transceiver off.
- 2 Remove the microSD.
- 3 Connect the microSD card to a PC using a commercially sold memory card reader.
- 4 Open the folder named [FT1D] within the microSD memory card.
- 5 Open the folder named [GPSLOG].

Data is saved with the name [GPSyymmddhhmmss.log].

The [yymmddhhmmss] part of the name represents year (yy), month (mm), day (dd), hour (hh), minute (mm), and second (ss).

Tip

- Tracks can be displayed on a personal computer using commercially sold map software by importing the GPS data.
- For information on importing and using the GPS data, please refer to the operation manual for the map software being used.

Explanation of GPS Screen and Operation

Activating the GPS function displays the following information on the LCD.

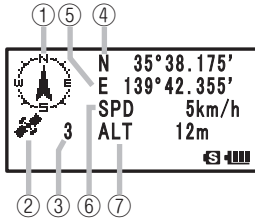

Press **MONO/DUAL (A/B)** to scroll the screen until the current time appears.

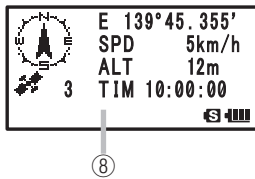

- ① **Compass:** North-UP (North is always up)
 Heading-UP: Heading-UP: (When **SCOPE BAND ON (BAND)** is pressed, the direction in which you are heading is always up. A white arrow icon appears. [H] appears at the lower right of the compass icon.
- ② **Positioning:** When at least three satellites have been acquired, appears.
 This icon does not appear on the LCD if the transceiver cannot acquire at least three satellites.
- ③ **Number satellites:** displays the number of acquired satellites.
- ④ **Latitude:** The current position appears using north (N) or south (S) latitude.
 Display format: X DD° MM. MMM
 X: X=N: North latitude, X=S: South latitude
 DD: Degree
 MM.MMM: Minute
 Example: N 35° 38.250 (35 degrees, 38 minutes, 15 seconds north latitude)
- ⑤ **Longitude:** The current position appears using east (E) or west (S) longitude.
 Format: X DDD° MM. DMMM
 X: X=E: East longitude, X=W: West longitude
 DDD: Degree
 MM.MMM: Minute
 Example: E 139° 42.500 (139 degrees, 42 minutes, 30 seconds east latitude)
- ⑥ **Speed:** The speed at which you are moving appears.
 Format: SPD aaakm/h
 Example: SPD 5 km/h
- ⑦ **Altitude:** The altitude of the current position of your radio station appears.
 Format: ALT aaaaaam
 Example: ALT 20m
- ⑧ **Time:** The current time set by GPS appears.
 Format: aa (hour): bb (minute): cc (second)
 Example: 23:59:59 (23 hours 59 minutes 59 seconds)
 * When an external GPS device is connected to the data terminal, the time appears as follows:
 aa (hour): bb (minute)

Tips

- You can change the unit of GPS data by selecting [9 APRS] → [22 GPS UNIT] in the Set mode.
- When the GPS function is used, the accurate time data (date and time) obtained from GPS appears on a 24 hour basis. This time data is reflected in the time data displayed on the GPS and APRS screens.
- You can change the geodetic system of the built-in GPS unit by selecting [9 APRS] → [19 GPS DATUM] in the Set mode. However, since APRS uses the geodetic system of WGS-84, it is recommended not to change it.
- You can set the time zone by units of 30 minutes by selecting [9 APRS] → [28 TIME ZONE] in the Set mode (Default: UTC +0:00).
- When the GPS function is active, the power consumption increases by about 30 mA. As a result, the battery life is reduced by about 20% compared to when the GPS function is deactivated.
- You can obtain position information from an external GPS device by selecting [9 APRS] → [17 COM PORT SETTING] and then setting [INPUT] to [GPS] in the Set mode. In this case, the data obtained from the internal GPS is disabled.
- When using an external GPS device, keep it away from the transceiver.

Smart Navigation Function

Using the Smart Navigation Function



There are 2 methods of navigation with the Smart Navigation function.

- (1) Real-time navigation function
- (2) Backtrack function

•Real-Time Navigation Function

GPS position information and voice signals are simultaneously transmitted in the V/D mode of C4FM digital.

For this reason, the position and direction of the remote station can be displayed in real-time even during communication.

- 1 Press  to open the GPS screen.
- 2 Turn  to select [YR].

The distance and direction of the remote station operating on the same frequency in the V/D mode is displayed.

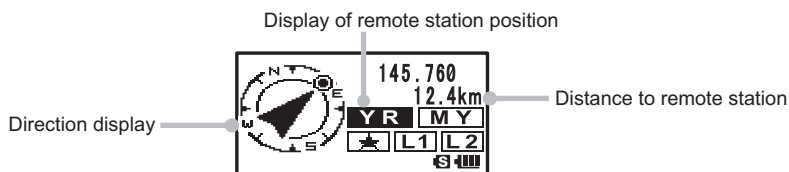

- 3 Press .







The screen returns from the navigation screen to the normal frequency display.

Smart Navigation Function

•Backtrack Function



By registering a point of departure beforehand, the distance and direction to the registered position from your current position can be displayed in real-time.

•Registering your current position (point of departure) (up to 3 positions can be registered)

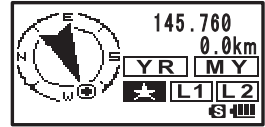
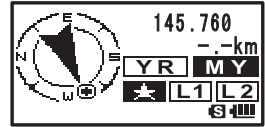
- 1 Press  to open the Backtrack screen.
- 2 Turn  to select [MY].
- 3 Press  to display the position information of your station.
- 4 Turn  to select a mark to register from [☆], [L1], and [L2].
- 5 Press  to register the position information to the selected mark and return to the BACK TRACK function screen.
- 6 Press  to return from the backtrack screen to the normal frequency display.



•Using the Backtrack Function

- 1 Press  to open the Backtrack screen.
 - 2 Turn  to select [☆], [L1] or [L2].
- Select the mark with the registered position you would like to backtrack.

The registered position (departure point) is in the direction of the arrow within the circle. Walk forward so that the arrow stays pointing up on the screen.

- 3 Press  to return from the backtrack screen to the normal frequency display.
- To verify the position again, press [DISP] to open the backtrack screen.

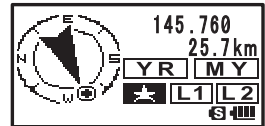

Description of the BACK TRACK Function Screen



Dual Reception (DW) Function

The FT1DR/DE is equipped with the following 3 types of Dual Reception Functions:

- (1) VFO Dual Reception
- (2) Memory Channel Dual Reception
- (3) Home Channel Dual Reception

The transceiver checks the standby side signal reception over the frequency registered to the selected memory channel (Priority Memory Channel) once approximately every 5 seconds. When the transceiver detects signal reception on the standby side, it starts signal reception over the frequency registered to the selected memory channel.

Even while receiving a signal over the frequency registered to a priority memory channel on the standby side, pressing  disables the Dual Reception function and allows for transmission over the former active side frequency.

Example: Checking signal reception over a frequency registered to the priority memory channel [90] (standby side), while receiving signal over [145.500 MHz] (active side).

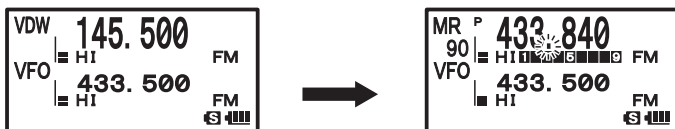









Frequency over which a signal is being received.

The transceiver monitors signal reception over the frequency registered to the Priority Memory Channel [90] (standby) and checks it in intervals of approximately 5 seconds.

When the transceiver receives a signal over the frequency registered to the priority memory channel [90], dual reception stops and signal reception switches to [90] (standby).

VFO Dual Reception

VFO mode → Priority memory channel

- 1 Switch to the Memory mode.
- 2 Press and hold  for over 1 second to enter the Write mode;  and the channel number blink on the LCD.
- 3 Turn  to select a memory channel, then press and hold  for over 1 second.
Select a memory channel to prioritize for signal reception (Priority Memory Channel). The "P" appears on the LCD.
- 4 Turn  to select a frequency for signal reception.
Select a frequency for continual signal reception in VFO mode (active side).
- 5 Press  and then  to start Dial Dual Reception, and [VDW] appears on the LCD.
- 6 Press  stop the Dial Dual Reception.

"P" is displayed.





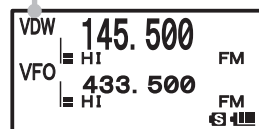



"VDW" is displayed.



Dual Reception (DW) Function

Memory Channel Dual Reception

Memory channel → Priority memory channel

- 1 Switch to the Memory mode.
- 2 Press and hold  over 1 second to enter the Write mode;  and the channel number blink on the LCD.
- 3 Turn  to select a memory channel and press . "P" is displayed.
Select a memory channel to prioritize for signal reception (Priority Memory Channel) (standby side). The "P" appears on the LCD.
- 4 Select a memory channel for signal reception.
Select a memory channel for signal reception at all times (active side).
- 5 Press  and then  to start Memory Channel Dual Reception; and [MDW] appears on the LCD.
- 6 Press  to stop the memory channel dual reception.











"MDW" is displayed.



Home Channel Dual Reception

Home channel → Priority memory channel

- 1 Switch to the Memory mode.
- 2 Press and hold  over 1 second to enter the Write mode.  and the channel number blink on the LCD.
- 3 Turn  to select a memory channel and press . "P" is displayed.
Select a memory channel to prioritize for signal reception (Priority Memory Channel) (standby side). The "P" appears on the LCD.
- 4 Press  and then  to recall a HOME channel (active side).
- 5 Press  and then .
HOME Channel Dual Reception starts and [MDW] appears on the LCD.
- 6 Press  to turn home channel dual reception OFF.

"P" is displayed.



"HDW" is displayed.



Caution

Be sure to set a memory channel as the Priority Memory Channel for standby before using this function.

Tips

- The Priority Memory Channel is set to the Memory Channel number 1 by default.
- Pressing and holding SET (DISP) over 1 second and changing the Set mode option allows you to use this function more conveniently.
[5 SCAN] → [1 DW TIME]: The interval for monitoring the Priority Memory Channel can be changed.
[5 SCAN] → [4 SCAN RESUME]: The resumption conditions for Dual Reception can be changed.
- The combination of the frequency bands and modes of the frequency for the Priority Memory Channel (standby side) and the frequency for continual signal reception (active side) can be freely changed.

AF-DUAL Function for simultaneous signal reception over the other frequency while listening to the radio

The AF-DUAL Reception Function allows reception of a radio broadcast, while standby reception of A-band or B-band frequency (or frequency registered to a memory channel) is active. When standby reception is active, voice received over that frequency cannot be heard, however if a voice signal is detected, the reception of the radio broadcast will be paused and voice will be heard. Although there is a similar function in Dual Reception (See page 76), because a signal reception over the frequency registered to the priority memory channel is checked approximately every 5 seconds in Dual Reception, the reception for radio broadcast is interrupted every time this happens. With the AF-DUAL Reception Function, the reception of radio broadcast is interrupted only when there is a calling signal from another transceiver.

•Listening Radio Broadcast with AF-DUAL Reception Function

- 1 Set the A-band or B-band frequency (or Memory Channel/Home Channel) for standby. Set the standby reception frequency for A-band or B-band (or Memory Channel/Home Channel) to monitor for calls while receiving radio broadcast.

- Tips**
- You can listen to radio broadcast while scanning the standby signal reception frequencies.
 - Radio broadcast can be listened to while monitoring the standby signal reception frequency in the dual reception mode.

- 2 Press MONO/DUAL (A/B) to set the operating band to A-band.
- 3 Press MW and then AF DUAL (MNO) to activate the AF-Dual function.
- 4 Press $\text{SCOPE BND DN (BAND)}$ and select [AM] or [WFM].

The broadcast band is toggled in the following order every time $\text{SCOPE BND DN (BAND)}$ is pressed:

AM broadcast (middle wave band) ⇔ FM broadcast ⇔ AM broadcast (middle wave band)

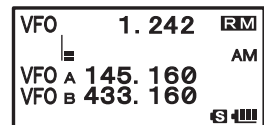
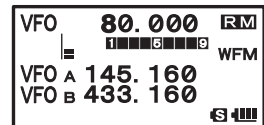

On the LCD, AM (AM broadcast) or WFM (FM broadcast) is displayed.

- 5 Turn DIAL to tune in to the frequency of broadcast station.











Dual Reception (DW) Function

Tips

- For broadcast station frequencies, refer to “Preset Broadcast Station Frequencies List (See page 54)” or a commercially sold frequencies list.
- AF-DUAL reception function can be used for the radio frequency registered to the memory bank.
- Pressing  while a signal is being received, will switch to receiving the standby reception frequency.
- With the AF-DUAL Function, an A Band or B Band registered with a AM broadcast (middle wave frequency) or a FM broadcast frequency, set for standby reception, cannot be simultaneously received while listening to the radio.
- To disable the AF-DUAL Function, press  and then  .
The frequency registered to the standby (memory channel) appears on the LCD.

•Setting the resumption time of radio reception

While receiving radio broadcast (active side) and ham radio band (A-band or B-band) on standby side, the transceiver may be set to resume receiving the broadcast audio [After loss of receive signal] or [After transmission].

- 1 Press and hold  for over 1 second to enter the Set mode.
- 2 Turn  to select [2 TX/RX].
- 3 Press .
- 4 Turn  to select [3 AUDIO].
- 5 Press .
- 6 Turn  to select [3 RX AF DUAL].
- 7 Press .
- 8 Turn  to select reception time.

Set transmission time as well.

Transmission and reception for 1 second to 10 seconds, HOLD (Fixed), or transmission for 1 second to 10 seconds.

Remarks Default setting: transmission and reception for 2 seconds

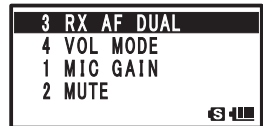
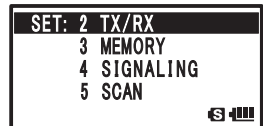

Display	Operation
Transmission and reception: 1 second to 10 seconds	While receiving radio broadcast and ham radio band frequencies (A-band and B-band) on standby simultaneously with [AF-DUAL Reception Function], resumption of receiving radio broadcast can be set to [After loss of receive signal] or [After transmission]. For example, if 5 seconds is selected, radio reception resumes after 5 seconds after reception (or transmission) ends.
Fixed	While receiving radio broadcast and ham radio band frequencies (A-band and B-band) on standby simultaneously with [AF-DUAL Reception Function], the transceiver will continue to receive a signal over that frequency after signal detection without switching back to radio broadcast.











Display	Operation
Transmission: 1 second to 10 seconds	While receiving radio broadcast and ham radio band frequencies (A-band and B-band) on standby simultaneously with [AF-DUAL Reception Function], the transceiver switches signal reception to the standby upon detecting it. After the user transmits signal for response and transmission ends, the transceiver switches signal reception back to radio broadcast after the specified time from the end of transmission. If a signal is received before transmitting it, [AF-DUAL Reception Function] is disabled and the transceiver continually receives a signal over that frequency.

- 9 Press  to set the radio broadcast resumption time for reception and Transmission, and exit the Set mode.



Using the DTMF Function

DTMF (Dual Tone Multi Frequencies) is the tone signal sent for making a call through DTMF telephone line. The maximum of 16 digit DTMF code can be registered (up to 10 channels) for telephone numbers to make a call through the public telephone line from a phone patch.

- Press and hold  for over 1 second to enter the Set mode.
- Turn  to select [4 SIGNALING].
- Press .
- Turn  to select [5 DTMF SELECT].
- Press .
- Turn  to select a memory channel to register the DTMF code (1 to 10).
- Press .
- Input the DTMF code with .
 - Tips**
 - DTMF code can also be entered with the numeric keys.
 - To delete a code, press . When  is pressed, a code is deleted and the cursor moves to left.
- Press  to move the cursor.
- Repeat steps 8 and 9 to enter the DTMF code.

Tips The maximum of 16 digits for DTMF code can be entered.

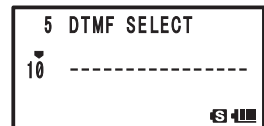
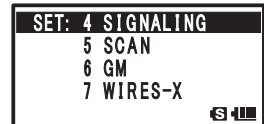









Using the DTMF Function

- 11 Press  to set the DTMF code and exit from the Set mode.







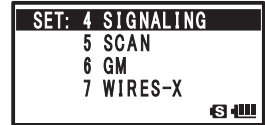







Confirming the entered DTMF code by the sound

- 1 Press and hold  for over 1 second to enter the Set mode.
- 2 Turn  to select [4 APRS].
- 3 Press .
- 4 Turn  to select [5 SCAN].
- 5 Press .
- 6 Turn  to select the memory channel to which the DTMF code was registered.
- 7 Press  to confirm the registered DTMF code by the audio tones.
- 8 Press  to exit from the Set mode.



Sending the Registered DTMF Code

- 1 Press and hold  over 1 second to enter the Set mode.
- 2 Turn  to select [4 SIGNALING].
- 3 Press .
- 4 Turn  to select [4 DTMF MODE].
- 5 Press .
- 6 Turn  to select [MODE].
- 7 Press .
- 8 Turn  to select [AUTO].
- 9 Press .
- 10 Press  to set the auto dialer.
- 11 While pressing  key, press  to  to select the DTMF memory channel to transmit with the numeric keys.







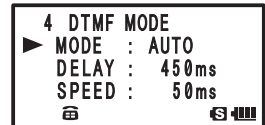
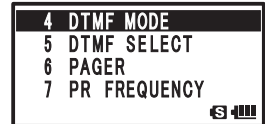
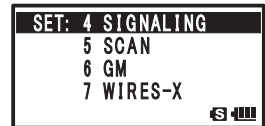





- Tips**
- The registered DTMF code is transmitted.
 - The transmitted DTMF tone can be heard from the speaker.

- 12 Release .

Even if  is released, the DTMF tone signal will continue to be transmitted until transmission of the signal is complete.



Sending a DTMF Code Manually

- 1 Press and hold  for over 1 second to enter the Set mode.
- 2 Turn  to select [4 SIGNALING].
- 3 Press .
- 4 Turn  to select [4 DTMF MODE].
- 5 Press .
- 6 Turn  to select [MODE].
- 7 Press .
- 8 Turn  to select [MANUAL].
- 9 Press .
- 10 Press  to set [MANUAL].
- 11 While pressing , select the DTMF code to transmit by pressing  to , A, B, C, *, and # on the numeric keys.

- Tips**
- The DTMF code selected by pressing the keys is transmitted (refer to chart below).
 - The transmitted DTMF tone can be heard from the speaker.

- 12 Release .

Even if  is released, the DTMF tone signal will continue to be transmitted until transmission of the signal is complete.

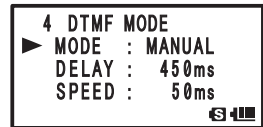
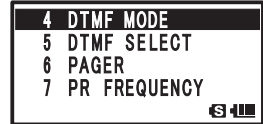
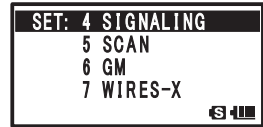



Tips

- The DTMF code is a combination of 2 frequencies.



	1209Hz	1336Hz	1477Hz	1633Hz
697Hz	1	2	3	A
770Hz	4	5	6	B
852Hz	7	8	9	C
941Hz	*	0	#	D

Searching for signals with the signal strength graph. Band Scope Function

While in VFO mode, the Band Scope Function is available that will graphically display the strength of the signals on up to ± 50 channels, centered on the current main band frequency.

- 1 Turn  to tune in to your desired center frequency.
- 2 Press and hold  for over 1 second.

With the current frequency as the center, the strengths of any signals of each of the higher and lower 16 channels are shown on a graph.

- 3 Turn  to adjust the  to point to any of the displayed channels, and the signal on the indicated frequency can be received.
- 4 Press  to exit the band scope function.



Tips

- You can change the number of band scope channels setting by selecting [1 DISPLAY] → [4 BAND SCOPE] in the Set mode. The band scope channel setting can be changed to ± 5 channels, ± 9 channels, ± 16 channels, ± 24 channels, and ± 50 channels, instead of ± 16 channels.
- The band scope channel interval is the same as the VFO frequency step.
- When band scope is active, the numeric keys will not function.
- The audio of A/B common frequency band can be heard simultaneously while scanning.
- FULL: Continually scans(scoops).
1Time: Scans(scoops) only once.
If the frequency is changed with , scan will resume.
* FULL is only selected in the analog mode.
* 1Time is only selected in the digital mode.

Taking picture with the optional camera mounted on speaker microphone

Pictures can be taken by connecting the speaker microphone with optional camera (MH-85A11U).

Captured image data can be saved to a microSD memory card placed in the transceiver. Saved image data can be sent to another transceiver in the digital mode or using the GM function.

In addition, image data can be transmitted to other transceivers* by pressing the  (Send Image Button) on the camera mounted on speaker microphone.

- * Refer to the Yaesu homepage or catalog for the models of transceiver to which images can be transferred.
- * Only the picture just taken can be sent to another transceiver. For methods to send other image data, refer to the GM Function instruction manual.

Taking picture with the optional camera mounted on speaker microphone.

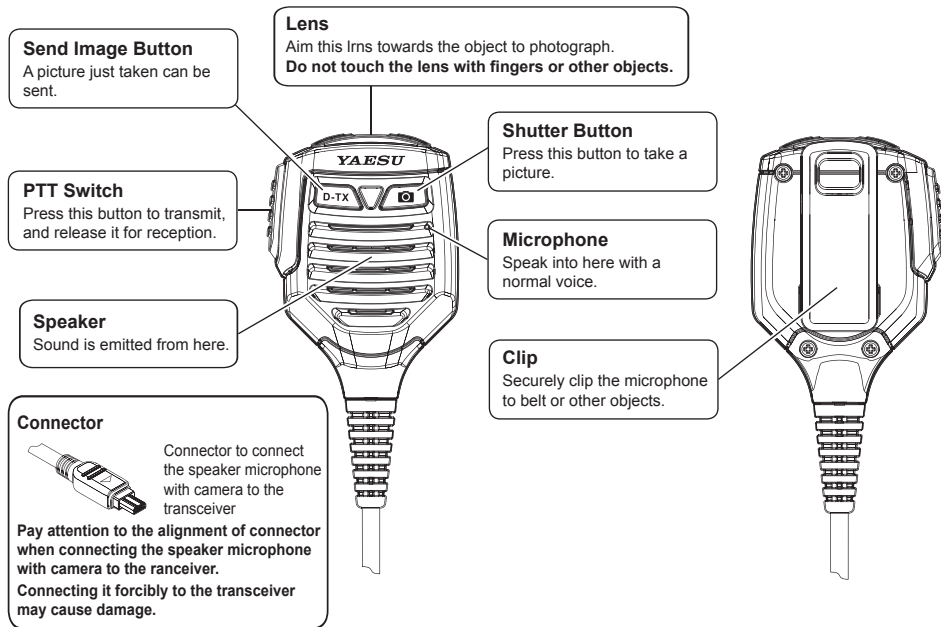

1 Connect the speaker microphone with camera (MH-85A11U) to the DATA terminal of the transceiver.

2 Press  to turn the transceiver on.

3 Press .

Point the lens towards the object to shoot and press .

Make sure to have at least 50cm between the lens and the object. If the object is too close, the picture will be out of focus, resulting in a blurred picture.

Tips • You can set the picture size (resolution) and image quality (compression rate) of the image, by selecting [11 OPTION] → [1 USB CAMERA] in the Set mode.

• Captured images are saved to the microSD memory card installed in the transceiver.





• If your transceiver and another compatible transceiver are both in digital mode, a picture just taken may be sent to the other transceiver by pressing .

Caution

- Do not directly photograph objects with strong light, such as the sun or other bright objects. Such operation can lead to malfunction.
- If the lens or the microphone gets dirty, use a dry, soft cloth to wipe off the contaminants.
- Do not place the MH-85A11U near heat emitting equipment or where it is exposed to direct sunlight. Doing so can lead to fire or a malfunction.
- Do not drop the MH-85A11U. Applying a strong shock to the MH-85A11U may result in damages or failure.

Using the Tone Squelch Function

The tone squelch opens the squelch only when a signal containing the specified frequency tone is received. Use of the digital code squelch (DCS) opens the squelch only when a signal containing the specified DCS code is received. The tone squelch function mutes monitoring the communications between other stations, even when listening for a call by a specific station for a long time.

- 1 Press and hold  over 1 second.
- 2 Turn  to select [4 SIGNALING].
- 3 Press .
- 4 Turn  to select [11 SQL TYPE].
- 5 Press .

The Set mode option [11 SQL TYPE] is selected.

- 6 Turn  to select a squelch type.

Select a squelch type with reference to the table shown below.

- 7 Press  to set the squelch type and exit the Set mode.

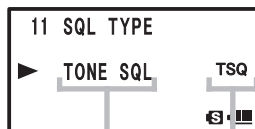
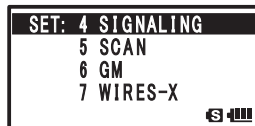

Displays squelch type

Displays logo

Tips

- The tone squelch and DCS setting are also active during scanning. If scanning is performed with the tone squelch or the DCS function turned on, it stops only when a signal containing a tone of the specified frequency or a signal containing the specified DCS code is received.
- Pressing the Monitor switch allows you to hear signals that do not contain a tone or DCS code, and signals with different tones or DCS code.
- Pressing and holding  for 1 second, and then changing the Set mode option allows you to use this function more conveniently.
[4 SIGNALING] → [3 DCS INVERSION]: Allows you to receive the DCS code of the inverted phase.
[4 SIGNALING] → [10 SQL EXPANTION]: Allows you to specify different squelch types for transmission and reception respectively.







Display	Operation
OFF	Turns off the tone sending function, tone squelch function, etc.
TONE	Just sends tones ([TN] appears).
TONE SQL	Turns on the tone squelch function ([TSQ] appears).
DCS	Turns on the digital code squelch ([DCS] appears).
REV TONE	Turns on the reverse tone ([RTN] appears). Used to monitor communications based on the squelch control system in which a tone signal is contained when communication is not performed and the tone signal disappears when communication starts.

Display	Operation
PR FREQ	Turns on the no-communication squelch function for radios ([PR] appears.). You can specify no-communication signal tone frequencies within the range from 300 Hz to 3000 Hz in steps of 100 Hz.
PAGER (See page 90)	Turns on a new pager function ([PAG] appears). When using transceivers with your friends, specifying personal codes (each code is composed of two tones) allows only a specific station to be called.
D CD*	Sends a DCS code only in case of transmission ([DC] appears).
TONE-DCS*	Sends a tone signal in case of transmission, and waits for a DCS code in case of reception ([T-D] appears).
D CD-TONE SQL*	Sends a DCS code in case of transmission, and waits for a tone signal in case of reception ([D-T] appears).

* Pressing and holding  over 1 second and selecting [4 SIGNALING] → [10 SQL EXPANTION] and then [ON] will add the setting items of D CD, ONE-DCS, and D CD TONESQ to [10 SQL TYPE] of the Set mode option [4 SIGNALING], allowing you to select different types of squelches for transmission and reception.

Selecting a Tone Frequency

You can select a tone frequency from among 50 frequencies (67.0 Hz to 254.1 Hz).

- 1 Specify the operating frequency.
- 2 Press and hold  over 1 second.
Enters the Set mode.
- 3 Turn  to select [4 SIGNALING].
- 4 Press .
- 5 Turn  to select [12 TONE SQL FREQ].
- 6 Press .
- 7 Turn  to select a tone frequency.
- 8 Quickly press  3 times to save the tone frequency setting and exit the Set mode.

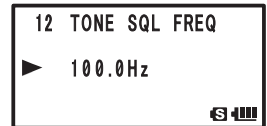
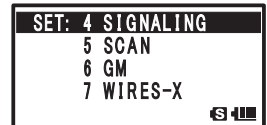











Tips

- The tone frequency selected using the above-described procedure is also effective when only the tone is sent out.
- By default, the tone frequency is set to 88.5 Hz.

Searching for the Frequency of the Tone Squelch Used by the Remote Station

The frequency of the tone squelch used by the remote station can be searched for and displayed.

Enter the Set mode:

- 1 Press and hold  for over 1 second.
- 2 Turn  to select [4 SIGNALING].
- 3 Press .
- 4 Turn  to select [11 SQL TYPE].
- 5 Press .
- 6 Turn  to select [TONE SQL].
- 7 Press .
- 8 Turn  to select [12 TONE SQL FREQ].
- 9 Press .
- 10 Receive the signal from the remote station.
- 11 Press and hold  over 1 second.
[TONE SEARCH] appears.

- 12 Release .

Search for the tone frequency starts.

When a corresponding tone frequency is detected, a beep is emitted and search stops temporarily. The detected tone frequency blinks.

Tip To set the searched tone frequency and exit from the Set mode:

Press  → a beep is emitted. → Quickly press  3 times.

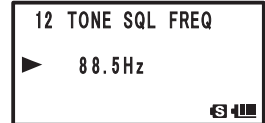
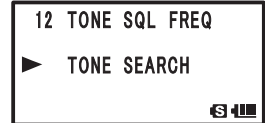
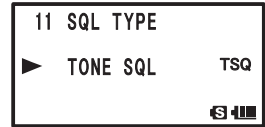
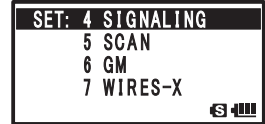





Tip



For the operation to perform when scan stops, refer to “Selecting a Reception Method When Scanning Stops” on page 59.

Selecting a DCS Code

You can select a DCS code from among 104 DCS codes (023 to 754).

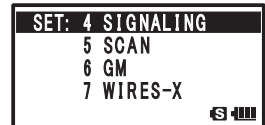
- 1 Specify the operating frequency.
- 2 Press and hold  over 1 second to enter the Set mode.
- 3 Turn  to select [4 SIGNALING].
- 4 Press .
- 5 Turn  to select [2 DCS CODE].
- 6 Press .



- 7 Turn  to select a DCS code.
- 8 Quickly press  3 times to set the DCS code and exit from the Set mode.

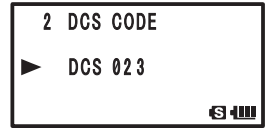









**Tip**

By default, the DCS code is set to [023].

Searching for the Frequency of the DCS Used by the Remote Station



The DCS code used by the remote station can be searched for and displayed.

Enter the Set mode:

- 1 Press and hold  over 1 second.
- 2 Turn  to select [4 SIGNALING].
- 3 Press .
- 4 Turn  to select [11 SQL TYPE].
- 5 Press .
- 6 Turn  to select [DCS].
Sets the DCS.
- 7 Press .
- 8 Turn  to select [2 DCS CODE].
- 9 Press .
- 10 Receive the signal from the remote station.
- 11 Press and hold  over 1 second.
[DCS SEARCH] appears.
- 12 Release .

Searching for the DCS code begins. When a corresponding DCS code is heard, a beep is emitted and search stops temporarily. The found DCS code blinks.

Tip To set the searched DCS code:

Press  → a beep is emitted. → Quickly press  3 times to set the DCS code and exit from the Set mode.

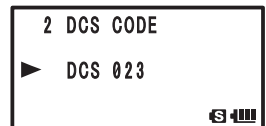
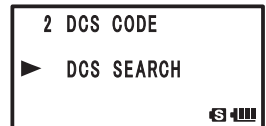
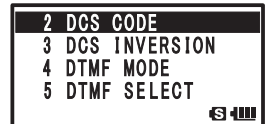
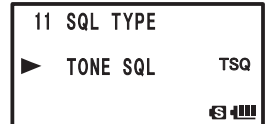
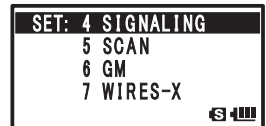







**Tip**

To perform the operation when scan stops, refer to "Selecting a Reception Method When Scanning Stops" on page 59.

Notification of Call from the Remote Station by Vibration of the Vibrator

Set the vibrator to alert you of a call from a remote station containing a corresponding CTCSS tone or DCS code.

Enter the Set mode:

- 1 Press and hold  over 1 second.
- 2 Turn  to select [8 CONFIG].
- 3 Press .
- 4 Turn  to select [22 VIBRATOR].
- 5 Press .
- 6 Turn  to select [MODE].
- 7 Press .
- 8 Turn  to select [SIGNALING].
- 9 Press  to set the Vibrator mode and exit the Set mode.

Tip To turn off the Vibrator function, select [OFF] in step 7.

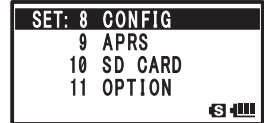



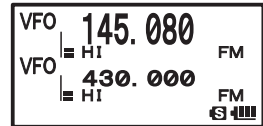

Tips

- The vibrator function can be set for all frequency bands belonging to A-band (Main) and B-band (Sub).
 - Selecting [8 CONFIG] → [22 VIBRATOR] → [MODE] and then [BUSY] for [MODE] in the Set mode will cause the vibrator to start vibrating when the BUSY LED lights upon reception of a signal.
 - If the BUSY state is not held continuously over 5 seconds, the suspended state is canceled.
- If the  switch is operated to change the communication mode from transmission to reception when the vibrator is turned ON, the vibrator function is turned off for 5 seconds.





Selecting Vibrator Operation Mode

Enter the Set mode:

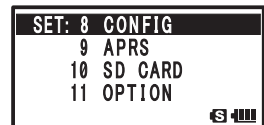
- 1 Press and hold  over 1 second.
- 2 Turn  to select [8 CONFIG].
- 3 Press .
- 4 Turn  to select [22 VIBRATOR].
- 5 Press .



- 6 Turn  to select [SELECT].
- 7 Press .
- 8 Turn  to select a vibrator operation mode.

Remark Default: MODE1

MODE1	The vibrator vibrates continuously.
MODE2	The vibrator operates at long intervals.
MODE3	The vibrator operates at short intervals.











- 9 Press .
- Sets the Vibrator mode and exits from the Set mode.

Notification of a Call from a Remote Station by the Bell

Set the Bell sound and the blinking  icon on the LCD, to alert you of a call from a remote station containing a corresponding CTCSS tone or DCS code.

Enter the Set mode:

- 1 Press and hold  over 1 second.
- 2 Turn  to select [4 SIGNALING].
- 3 Press .
- 4 Turn  to select [1 BELL].
- 5 Press .
- 6 Turn  to select [SELECT].
- 7 Press .
- 8 Turn  to select [BELL].



When the tone squelch or DCS function is turned on, the  icon appears.

- 9 Press .

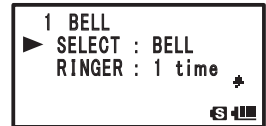
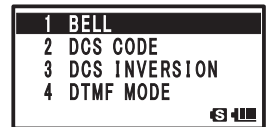
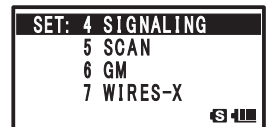
Tip To turn off the bell function, select [OFF] in step 6.





Tips

- To use the bell function, turn on the tone squelch or DCS function.
- The bell function cannot be used via the repeater.
- The  icon appears when the bell function is turned on. Upon receipt of a signal from a remote station, the  icon blinks.







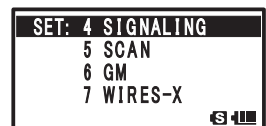

Changing the Number of Times the Bell Rings

Enter the Set mode:

- 1 Press and hold  over 1 second.
- 2 Turn  to select [4 SIGNALING].
- 3 Press .



Using the Tone Squelch Function

- 4 Turn  to select [1 BELL].
- 5 Press .
- 6 Turn  to select [RINGER].
- 7 Press .
- 8 Turn  to select the number of times the bell rings.
Remark Default: Once
Tip You can select the number of times the bell rings from among 1 to 20 times, or continuous.
- 9 Press  to set the selected number of times the bell rings and exit from the Set mode.

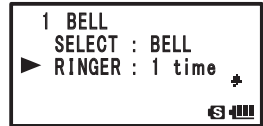

Calling Only a Specific Station — New Pager Function

When using the transceivers with your friends, specifying personal codes (each code composed of two CTCSS tones) allows you to call only a specific station. Even if the called person is not near his or her transceiver, the information on the LCD indicates that he or she has been called.

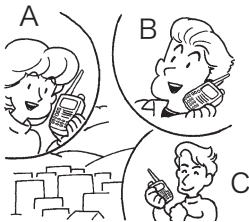

Three persons A, B, and C are using the transceiver.



Mr. C sends the personal code of Mr. B.



Only Mr. B is called.



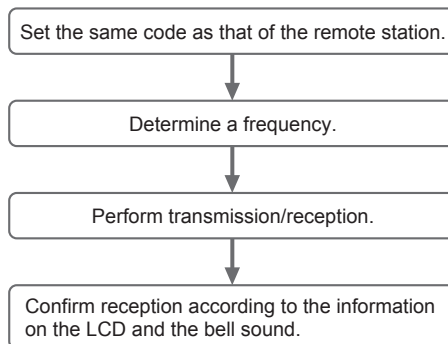







Flow of Operation to Use the Pager Function



Setting the Code of Your Station

Set the personal code (your code) to be called by other stations.

Enter the Set mode:

- 1 Press and hold  over 1 second.
 - 2 Turn  to select [4 SIGNALING].
 - 3 Press .
 - 4 Turn  to select [6 PAGER].
 - 5 Press .
 - 6 Turn  to select [CODE-RX].
 - 7 Press .
 - 8 Turn  to select a code.
Select the first code from among 1 to 50.
 - 9 Press .
- The cursor [*] moves.
- 10 Turn  to select a code.
Select the second code from among 1 to 50.

Caution The second code must be different from the first code.

- 11 Press  to set your station code and exit from the Set mode.





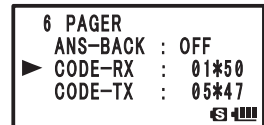
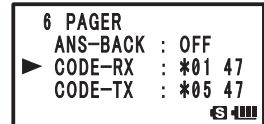
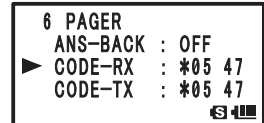
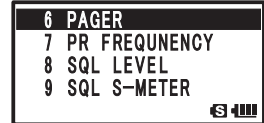
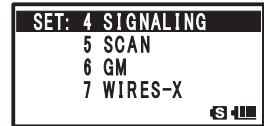

Tips • Default: 05 47

- The first and second codes contained in your personal code may be reversed, i.e., [47 05] from [05 47] but recognized as the same code.
- If the same personal code (group code) is specified for all persons, all persons can be called at the same time.



Turning on the New Pager Function

Enter the Set mode:

- 1 Press and hold  over 1 second.
- 2 Turn  to select [4 SIGNALING].
- 3 Press .
- 4 Turn  to select [11 SQL TYPE].
- 5 Press .
- 6 Turn  to select [PAGER].
- 7 Press  to set the new pager function and exit from the Set mode.

You can make a call, or wait for a call from a remote station, using the new pager function.

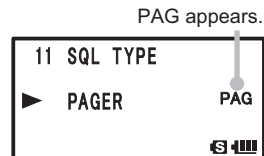
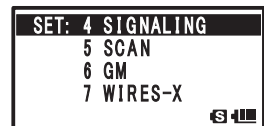

Calling a Specific Station

Enter the Set mode:

- 1 Press and hold over 1 second.
- 2 Turn to select [4 SIGNALING].
- 3 Press .
- 4 Turn to select [11 SQL TYPE].
- 5 Press .
- 6 Turn to select [PAGER].
Set the new pager function:
- 7 Press .
- 8 Turn to select [6 PAGER].
- 9 Press .
- 10 Turn to select [CODE-TX].
- 11 Press .
- 12 Turn to select the code of the remote station.
Select the first code of the remote station.

Caution Register the pager code of the remote station in advance.

- 13 Press .
- The cursor [*] moves.
- 14 Turn to select the code of the remote station.
Select the second code of the remote station.
- 15 Press to set the code of the remote station and exit from the Set mode.
- 16 Press to call the remote station.

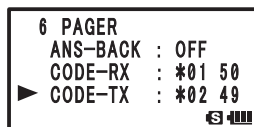
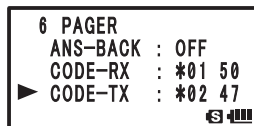
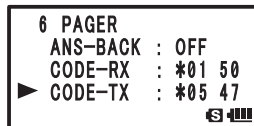
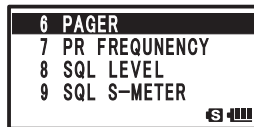
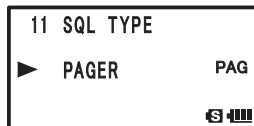
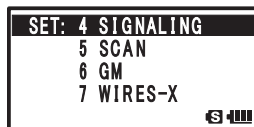

PAG appears.

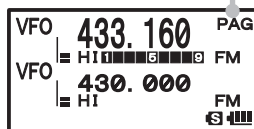

Being Called by the Remote Station (Standby Operation)

If you use the new pager function on the same frequency as the remote station, the [PAG] icon displayed on the LCD changes to [PIN], alerting that you have been called by the remote station. In addition, if you turn on the “bell function” (See page 89), you can confirm a call from the remote station by the [PAG] display, the blinking [PIN] icon, and the bell sound. Also, if you turn on the “vibrator function” (See page 88), the vibrator will confirm a call from the remote station.



Tip





Selecting [4 SIGNALING] → [9 PAGER ANS-BACK] → [ON] in the Set mode automatically places the transceiver in the transmission mode (for about 2.5 seconds) when called by the remote party, and notifies the remote party to get ready for communication.

Set Mode

Using the Set Mode

The Set mode allows you to select various functions from a list so you can use your transceiver more conveniently.

Enter the Set mode:



- 1 Press and hold  for over 1 second.
- 2 Turn  to select a Set mode option.
- 3 Press .
- 4 Turn  to choose a setting item.

Select a setting item:

- 5 Press .

[If there is no lower layer of setting items
Proceed to step 8.]

[If there is lower layer of setting items
continue with step 6.]

- 6 Turn  to select a setting item.
- 7 Press  to exit the Set mode.

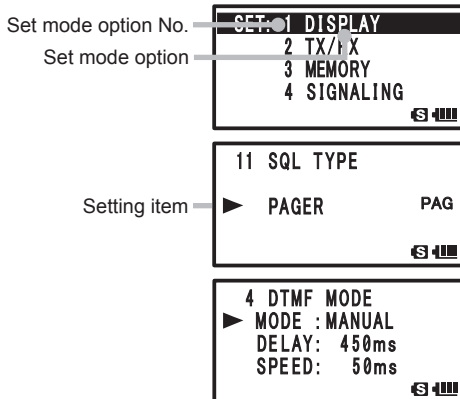

Resetting the Set Mode Options

The Set mode options you have set can be restored to the defaults by following the procedure described below. However, to restore the following setting items to the defaults, "ALL RESET" (See page 39) is required.

2-1-2 ANTENNA ATT

2-1-4 RX MODE

3-3 MEMORY NAME

4-2 DCS CODE

4-6 PAGER (CODE-RX/CODE-TX)

4-9 SQL S-METER

4-12 TONE SQL FREQ

8-5 CLOCK TYPE

8-15 RPT SHIFT

9-7 APRS MSG TXT

9-18 DIGI PATH

9-24 MY POSITION

12 CALLSIGN

2-1-3 HALF DEVIATION

3-2 BANK NAME

3-5 MEMORY SKIP

4-3 DCS INVERSION

4-7 PR FREQUENCY

4-11 SQL TYPE

7-4 EDIT CATEGORY TAG





8-12 PASSWORD

8-16 RPT SHIFT FREQ

9-15 BEACON STATS TXT

9-23 CALLSIGN (APRS)

9-25 MY SYMBOL (4:User)

- 1 Press  while pressing , and .
Then turn the transceiver on. When a beep is heard, release the keys.
- 2 When [SET MODE RESET PUSH F KEY] appears, press .
A beep is emitted.
Tip To cancel resetting, press any key other than .

Set Mode Option List

Set mode option No./ setting item	Description of function	Setting Item (Bold letters: Default)	Reference page
1 DISPLAY			
1-1 GPS INFO	Press  to open the GPS screen.	—	103
1-2 TARGET LOCATION	Set the display method for the BACKTRACK screen that appears when using the GM Function.	COMPASS / NUMERIC	104
1-3 COMPASS	Set the display method for BACKTRACK Compass.	HEADING UP / NORTH UP	104
1-4 BAND SCOPE	Switch the Search Channel for the BAND SCOPE operation mode.	11ch / 19ch / 33ch / 49ch / 101ch	105
1-5 LAMP	Set the duration time of backlight and keys to be lit.	OFF / 2 to 10 SEC (KEY) / CONTINUOUS KEY 5sec	105
1-6 LANGUAGE	Select Japanese or English as the display language for Set mode options, setting items, etc.	JAPANESE / ENGLISH	106
1-7 LCD CONTRAST	Set the LCD contrast level.	LEVEL 1 to LEVEL 15 Level 7	106
1-8 LCD DIMMER	Set the brightness level of the LCD backlight and keypad key light.	LEVEL 1 to LEVEL 6 Level 6	107
1-9 OPENING MESSAGE	Select an opening message type.	NORMAL / OFF / DC / MESSAGE / CALLSIGN	107
1-10 SENSOR INFO	Display function for electrical voltage and temperature.	Voltage & Temperature	108
1-11 S-METER SYMBOL	Select a S/PO meter symbol display type.	4 types	109
2 TX / RX			
2-1 MODE			
2-1-1 ANTENNA AM	Select an AM radio antenna type.	BAR & EXT / Bar Antenna	33
2-1-2 ANTENNA ATT	Set the attenuator to ON or OFF.	OFF / ON	109
2-1-3 HALF DEVIATION	Set the transmission modulation level.	OFF / ON	110
2-1-4 RX MODE	Select a reception mode.	AUTO / FM / AM	38
2-2 DIGITAL			
2-2-1 DIGITAL MODE	Select DIGITAL to switch to DIGITAL mode	MODE: DIGITAL / AMS / ANALOG DIG TX: DN / VW AMS MODE: TX M / TX FM / TX DN / TX VW / AUTO	111

Set Mode

Set mode option No./ setting Item	Description of function	Setting Item (Bold letters: Default)	Reference page
2-2-2 SQL TYPE	Select SQL Type in the DIGITAL mode.	SQL TYPE: OFF / CODE / BREAK CODE: 001 to 126	113
2-2-3 DIGI POP UP	Set the POP UP time.	OFF BND2s / BND4s / BND6s / BND8s / BND10s / BND20s / BND30s / BND60s / BND CNT	113
2-2-4 LOCATION SERVICE	Set whether or not to display the current location of your own station in the digital mode.	ON / OFF * For more details of this function, refer to the GM Function Instruction Manual.	
2-2-5 STANDBY BEEP	STANDBY BEEP setting	ON / OFF	114
2-2-6 DSP Ver	DSP version display	Version display	115
2-3 AUDIO			
2-3-1 MIC GAIN	Adjust the microphone gain level.	LEVEL 1 to LEVEL 9 LEVEL 5	115
2-3-2 MUTE	Set the muting level on the non-operating side when a signal is received on the operating band side.	OFF / MUTE30% / MUTE50% / MUTE 100%	35
2-3-3 RX AF DUAL	Set the resumption time of radio reception in the AF Dual mode.	Transmission and reception 1 second to 10 seconds, Fixed, or transmission 1 second to 10 seconds. Transmission 2 seconds	78
2-3-4 VOL MODE	Set [VOL] key.	NORMAL / AUTO BACK	116
3 MEMORY			
3-1 BANK LINK	Set memory bank link.	BANK 1 to BANK 24, BANK LINK ON / OFF	117
3-2 BANK NAME	Assign a name to a memory bank.	BANK1 to BANK24	49
3-3 MEMORY NAME	Enter a memory channel tag.	Up to 16 characters	47
3-4 MEMORY PROTECT	Allow or prohibit memory channel registration.	OFF / ON	118
3-5 MEMORY SKIP	Set memory channels or selected memory channels to skip.	OFF / SKIP / SELECT	60
3-6 MEMORY WRITE	Set the automatic increment to display memory channel to be registered.	NEXT / LOWER	118
4 SIGNALING			
4-1 BELL	Set the number of bell ring.	SELECT: OFF / BELL RINGER: 1 time to 20 times / Continuous	89
4-2 DCS CODE	Set the DCS code.	DCS 023 to DCS 754	86

Set mode option No./ setting item	Description of function	Setting Item (Bold letters: Default)	Reference page
4-3 DCS INVERSION	Select a combination of DCS inversion codes in terms of communication direction.	RX (Reception): -NORMAL (Homeomorphic) / INVERT (Inversion) / BOTH (Both Phase) / NORMAL (Homeomorphic) TX (Transmission): -NORMAL (Homeomorphic) / NORMAL (Homeomorphic) NORMAL (Homeomorphic) INVERT (Inversion)	119
4-4 DTMF MODE	Set the transmission of DTMF code registered to a DTMF memory channel, DTMF code transmission delay time, and DTMF code transmission speed.	MODE: MANUAL / AUTO DELAY: 50ms / 250ms / 450ms / 750ms / 1000ms SPEED: 50ms / 100ms	81
4-5 DTMF SELECT	Set a DTMF auto dialer channel and code (16 characters).	1 to 10	79
4-6 PAGER	Turn on/off the pager answerback function and specify a personal code (transmission/reception).	ANS-BACK: OFF / ON CODE-RX: 01 02 to 50 49 05 47 CODE-TX: 01 02 to 50 49 05 47	90
4-7 PR FREQUENCY	Set a non-communication squelch.	300 Hz to 3000 Hz 1600 Hz	120
4-8 SQL LEVEL	Select a squelch level.	Level 0 to Level 15 Level 1	121
4-9 SQL S-METER	Select an S-meter squelch level.	OFF / LEVEL 1 to LEVEL 9	121
4-10 SQL EXPLANATION	Set a separate squelch type for reception and transmission.	OFF / ON	122
4-11 SQL TYPE	Select a squelch type.	OFF / TONE / TONE SQL / DCS / REV TONE / PR FREQ / PAGER	84
4-12 TONE SQL FREQ	Set a tone frequency.	67.0 Hz to 254.1 Hz 100 Hz	85
4-13 TONE-SRCH	Set the audio output during tone search. Turn the muting function on/off and select a tone search speed.	MUTE: ON / OFF SPEED: FAST / SLOW	123
4-14 WX ALERT	Enables/Disables the Weather Alert Feature.	OFF / ON	124
5 SCAN			
5-1 DW TIME	Set the priority memory channel monitoring interval.	0.1 SEC to 10 SEC 5 SEC	124
5-2 SCAN LAMP	Set the scan lamp to light or not when scanning stops.	ON / OFF	125
5-3 SCAN RE-START	Set the scanning restart time.	0.1 SEC to 10 SEC 2 SEC	125
5-4 SCAN RESUME	Set the scan stop mode.	SCAN: BUSY / HOLD / 2sec to 10sec 5sec DW: BUSY / HOLD / 2sec to 10sec	59
5-5 SCAN WIDTH	Set the scan mode.	VFO: ALL / BAND MEMORY: ALL CH / BAND	126

Set Mode

Set mode option No./ setting Item	Description of function	Setting Item (Bold letters: Default)	Reference page
6 GM			
6-1 LANGUAGE	Select the language to use for writing a message, etc.	JAPANESE ENGLISH	–
6-2 DELETE GROUP	Delete a registered group.	–	–
6-3 DELETE MEMBER	Delete a registered member.	–	–
6-4 RADIO ID	Transceiver specific number(ID) appears. (This cannot be edited)	–	–
* For more details of this function, refer to the GM Function Instruction Manual.			
7 WIRES-X			
7-1 LANGUAGE	Select the language to use for writing a message, etc.	JAPANESE ENGLISH	–
7-2 RPT/WIRES FREQ	Set a frequency to be used for Repeater/WIRES.	MANUAL / PRESET	–
7-3 SERCH SETUP	Set the WIRES ROOM selection method.	HISTORY / ACTIVITY	–
7-4 EDT CATEGORY TAG	Edit a category tag.	C1 to C5	–
7-5 REMOVE ROOM/ NODE	Delete a registered Category ROOM.	C1 to C5	–
* For more details of this function, refer to the WIRES-X Function Instruction Manual.			
8 CONFIG			
8-1 APO	Set the APO operating time.	OFF / 0.5 HOUR / 1 HOUR to 12 HOURS	127
8-2 BCLO	Turn on/off the busy channel lock-out function.	OFF / ON	128
8-3 BEEP	Set the beep output function and the function of emitting a beep when a band edge/CH1 is encountered.	SELECT: KEY&SCAN / KEY / OFF EDGE: OFF / ON	128
8-4 BUSY LED	Turn on/off the BUSY LED.	A BAND: ON / OFF B BAND: ON / OFF RADIO: ON / OFF	129
8-5 CLOCK TYPE	Set the clock shift function.	A / B	129
8-6 GPS LOG	Set the GPS access time.	OFF / 1 SEC / 2 SEC / 5 SEC / 10 SEC / 30 SEC / 60 SEC	130
8-7 HOME VFO	ENABLE/DISABLE of VFO transmission in Home Channel.	ENABLE / DISABLE	130
8-8 LED LIGHT	Turn on/off the white LED flash-light.	–	131
8-9 LOCK	Select a lock mode.	KEY&DIAL / PTT / KEY&PTT / DIAL&PTT / ALL / KEY / DIAL	131
8-10 MONI/T-CALL	Select a monitor switch or T-CALL switch.	MONI / T-CALL *1	132
8-11 TIMER	Set the power ON/OFF timer.	ON: 00:00 to 23:59 ON / OFF OFF: 00:00 to 23:59 ON / OFF	132
8-12 PASSWORD	Turn on/off the password function.	ON / OFF [– – – –]	133

*1: Depends on the transceiver version.

Set mode option No./ setting Item	Description of function	Setting Item (Bold letters: Default)	Reference page
8-13 PTT DELAY	Set the PTT delay time.	OFF / 20ms / 50ms / 100ms / 200ms	134
8-14 RPT ARS	Turn the ARS function on/off.	ON / OFF	134
8-15 RPT SHIFT	Select a repeater shift direction.	Differs depending on frequency	135
8-16 RPT SHIFT FREQ	Select a repeater shift width.	Differs depending on frequency	135
8-17 SAVE RX	Set the reception save time.	OFF / 0.2 SEC (1:1) to 60.0 SEC (1:300)	136
8-18 STEP	Select a channel step.	AUTO / 5.0 kHz to 100 kHz	37
8-19 DATE & TIME ADJ	Set up the built-in clock function.	–	34
8-20 TOT	Set the timeout timer.	OFF / 30 SEC to 10 MIN 3.0min	136
8-21 VFO MODE	Select the frequency selection range in the VFO mode.	ALL / BAND	137
8-22 VIBRATOR	Select a vibrator mode and set up the vibrator function.	MODE: OFF / BUSY / SIGNALING SELECT: MODE1 / MODE2 / MODE3	88
9 APRS			
9-1 APRS AF DUAL	Turn on/off the muting function when both the APRS function and AF dual function are active.	ON / OFF	–
9-2 APRS DESTINATION	Displaying Model Code	APY01D (Cannot be edited.)	–
9-3 APRS FILTER	Select filter function	Mic-E: ON / OFF POSITION: ON / OFF WEATHER: ON / OFF OBJECT: ON / OFF ITEM: ON / OFF STATUS: ON / OFF OTHER: OFF / ON ALTNET: OFF / ON	–
9-4 APRS MODEM	Set the APRS baud rate	OFF / 1200bps / 9600bps	–
9-5 APRS MSG FLASH	Set the strobe to flash when there is an incoming message.	MSG: OFF / 2-4-10 (2sec interval) / 20sec / 30sec / 60sec / CONTINUOUS / EVERY 2s-10s (1sec interval) / EVERY 10s-EVERY 50s (10sec interval) / EVERY 1m-EVERY 10m (1min interval) GRP: OFF / 2-4-10 (2sec interval) / 20sec / 30sec / 60sec / CONTINUOUS BLN: OFF / 2-4-10 (2sec interval) / 20sec / 30sec / 60sec / CONTINUOUS	–

Set Mode

Set mode option No./ setting Item	Description of function	Setting Item (Bold letters: Default)	Reference page
9-6 APRS MSG GROUP	Set group filter for receiving messages.	G1: ALL ***** G2: CQ****** G3: QST***** G4: YAESU**** G5: B1: BLN***** B2: BLN* B3: BLN*	—
9-7 APRS MSG TXT	Enter standard message text 1 to 7ch	1 to 8 ch	—
9-8 APRS MUTE	Turn on/off the B-band AF muting function when APRS is set.	ON / OFF	—
9-9 APRS POPUP	Set such as a beacon type, message type and time for pop-up display.	Mic-E: OFF / ALL2s to ALL60s / ALLCNT / BND2s to BND60s / BNDCNT ALL10s POSITION: OFF / ALL2s to ALL60s / ALLCNT / BND2s to BND60s / BNDCNT ALL10s WEATHER: OFF / ALL2s to ALL60s / ALLCNT / BND2s to BND60s / BNDCNT ALL10s OBJECT: OFF / ALL2s to ALL60s / ALLCNT / BND2s to BND60s / BNDCNT ALL10s ITEM: OFF / ALL2s to ALL60s / ALLCNT / BND2s to BND60s / BNDCNT ALL10s STATUS: OFF / ALL2s to ALL60s / ALLCNT / BND2s to BND60s / BNDCNT ALL10s OTHER: OFF / ALL2s to ALL60s / ALLCNT / BND2s to BND60s / BNDCNT ALL10s MY PACKET: OFF / ALL2s to ALL60s / ALLCNT / BND2s to BND60s / BNDCNT ALL10s MSG: OFF / ALL2s to ALL60s / ALLCNT / BND2s to BND60s / BNDCNT ALL10s	—

Set mode option No./ setting Item	Description of function	Setting Item (Bold letters: Default)	Reference page
9-9 APRS POPUP	Set the beacon type, the message type and the time of the popup display.	GRP: OFF / ALL2s to ALL60s / ALLCNT / BND2s to BND60s / BNDCNT ALL10s BLN: OFF / ALL2s to ALL60s / ALLCNT / BND2s to BND60s / BNDCNT ALL10s MY MSG: OFF / BND2s to BND60s / BND10s DUP.BCN: OFF / BND2s to BND60s / BND10s DUP.MSG: OFF / BND2s to BND60s / BND10s ACK.REJ: OFF / BND2s to BND60s / BND10s OTHER MSG: OFF / BND2s to BND60s / BND10s	-
9-10 APRS RINGER	Turn on/off the bell when a beacon is received.	Mic-E: ON / OFF POSITION: ON / OFF WEATHER: ON / OFF OBJECT: ON / OFF ITEM: ON / OFF STATUS: ON / OFF OTHER: ON / OFF MY PACKET: ON / OFF MSG: ON / OFF GRP: ON / OFF BLN: ON / OFF MY MSG: ON / OFF DUP.BCN: ON / OFF DUP.MSG: ON / OFF ACK.REJ: ON / OFF OTHER MSG: ON / OFF TX BCN: ON / OFF TX MSG: ON / OFF	-
9-11 APRS UNIT	Select the units for APRS display.	Position: MM.MM' / MM'SS' Distance: km / mile Speed: km/h / knot / mph Altitude: m / ft Temp: °C / °F Rain: mm / inch Wind: m/s / mph	-
9-12 APRS TX DELAY	Set the data sending delay time.	100ms / 150ms / 200ms / 250ms / 300ms / 400ms / 500ms / 750ms / 1000ms	-

Set Mode





Set mode option No./ setting Item	Description of function	Setting Item (Bold letters: Default)	Reference page
9-13 BEACON INFO	Set the transmission beacon information.	AMBIGUITY: OFF / 1 dig to 4dig SPD / CSE: ON / OFF ALTITUDE: ON / OFF	–
9-14 BEACON INTERVAL	Set a beacon automatic sending interval.	30sec / 1min / 2min / 3min / 5min / 10min / 15min / 20min / 30min / 60min	–
9-15 BEACON STATS TXT	Input setting for status text.	S.TXT: ON / OFF TX RATE: 1/1 to 1/8 1 to 5 CH	–
9-16 BEACON TX	Select automatic or manual sending of beacon.	AUTO / MANUAL / SMART	–
9-17 COM PORT SETTING	Set the COM port.	STATUS: ON / OFF SPEED: 4800 / 9600 / 19200 / 38400 INPUT: OFF / GPS OUTPUT: OFF / GPS / WAY.P WAYPOINT: NMEA9 / NMEA6 / NMEA7 / NMEA8 Mic-E: ON / OFF POSIT: ON / OFF WEATHER: ON / OFF OBJECT: ON / OFF ITEM: ON / OFF	–
9-18 DIGI PATH	Select a digital repeater route.	P1 OFF P2 1 WIDE1-1 P3 1 WIDE1-1 / 2 WIDE2-1 P4 1 / 2 P5 1 / 2 P6 1 / 2 P7 1 / 2 P8 1 to 8	–
9-19 GPS DATUM	Select a datum used for the GPS function.	WGS-84 / Tokyo Mean / Tokyo Japan / Tokyo Korea / Tokyo Okinawa	–
9-20 GPS POWER	Turn on/off the GPS function.	GPS ON / GPS OFF	–
9-21 GPS TIME SET	Turn on/off the GPS time and date automatic acquisition function.	AUTO / MANUAL	–
9-22 GPS UNIT	Select the units for GPS display.	Position: . MMM ' / 'SS" Speed: km/h / Knot / mph Altitude: m / ft	–
9-23 CALLSIGN (APRS)	Specify the callsign of your station.	–	–
9-24 MY POSITION	Set the position for your station.	GPS / Lat N * ** * * * * * / LON * ** * * * * * P1 to P10	–
9-25 MY SYMBOL	Set the symbol for your station.	45 Icon	–

Set mode option No./ setting Item	Description of function	Setting Item (Bold letters: Default)	Reference page
9-26 POSITION COMMENT	Set up the position comment function.	Off Duty / En Route / In Service / Returning / Committed / Special / Priority / Custom 0 to 6 / EMERGENCY!	—
9-27 SmartBeaconing	Set the smart beaconing function.	STATUS: OFF / TYPE1 / TYPE2 / TYPE3 LOW SPD: 2mph to 30mph HIGH SPD: 31mph to 90mph SLOW RATE: 1min to 100min FAST RATE: 10sec to 180sec TURN ANGL: 5° to 90° TURN SLOP: 1 to 255 TURN TIME: 5sec to 180sec	—
9-28 TIME ZONE	Set the time zone.	UTC ±13.0 H / UTC+0:00	—
* For more details of functions, refer to the APRS Section in the instruction manual.			
10 SD CARD			
10-1 BACKUP	Write or read the information about your transceiver into or from the micro SD memory card.	Write to SD / Read from SD	138
10-2 MEMORY CH	Write or read the memory channel information into or from the micro SD memory card.	Write to SD / Read from SD	138
10-3 GROUP ID	Write or read GROUP ID information into or from the micro SD memory card.	Write to SD / Read from SD	139
10-4 FORMAT	Format the micro SD memory card.	Format	24
11 OPTION			
11-1 USB CAMERA	Set the USB CAMERA image size and resolution.	SIZE: 160 ×120 / 320×240 QUALITY: LOW / NORMAL / HIGH	140
12 CALLSIGN	Set the CALLSIGN.	—	141

Displaying the GPS screen.

When using the GPS function, you can display the GPS information on the LCD.

Enter the Set mode:



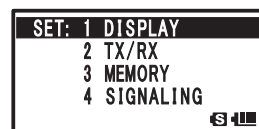



- 1 Press and hold  for over 1 second.
- 2 Turn  to select [1 DISPLAY].
- 3 Press .
- 4 Turn  to select [1 GPS INFO].
- 5 Press  to display the GPS information on the LCD.



Setting the display method of the remote station information

Set the display method of the remote station information when using the GM Function.

Enter the Set mode:

- 1 Press and hold  for over 1 second.
- 2 Turn  to select [1 DISPLAY].
- 3 Press .
- 4 Turn  to select [2 TARGET LOCATION].
- 5 Press .
- 6 Turn  to select the display method.
 COMPASS: Compass appears.
 NUMERIC: Longitude and latitude appear.
- 7 Press  to set the selected display method, and exit from the Set mode.

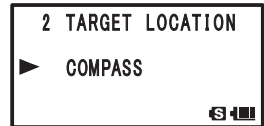
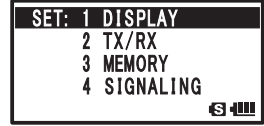







Caution

When the NUMERIC is selected, only the location information of the remote station appears on the LCD. The BACKTRACK function is not activated.

Setting the display method for BACKTRACK

You can set the BACKTRACK screen display method.

Enter the Set mode:



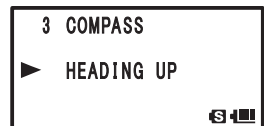
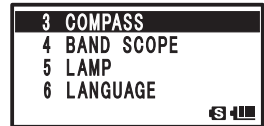
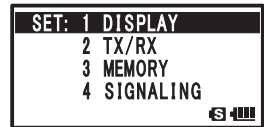



- 1 Press and hold  for over 1 second.
- 2 Turn  to select [1 DISPLAY].
- 3 Press .
- 4 Turn  to select [3 COMPASS].
- 5 Press .
- 6 Turn  to select the display method.
 HEADING UP: Heading direction is indicated upward.
 NORTH UP: North direction is indicated upward.
- 7 Press  to save the selected display setting and exit the set mode.



Setting the search channels for the BAND SCOPE function

You can set the number of channels to be displayed for the band scope when the BAND SCOPE function is used.

Enter the Set mode:



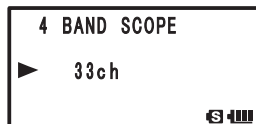
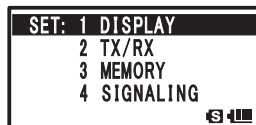



- 1 Press and hold  for over 1 second.
 - 2 Turn  to select [1 DISPLAY].
 - 3 Press .
 - 4 Turn  to select [4 BAND SCOPE].
 - 5 Press .
 - 6 Turn  to select the number of channels to search for.
11ch / 19ch / 33ch / 49ch / 101ch
- Remark** Default: 33ch
- 7 Press  to set the number of channels to search for, and exit the Set mode.



Changing the Lighting Condition

You can change the LCD and key lighting condition.

Enter the Set mode:

- 1 Press and hold  for over 1 second.
- 2 Turn  to select [1 DISPLAY].
- 3 Press .
- 4 Turn  to select [5 LAMP].
- 5 Press .
- 6 Turn  to select a lighting condition.
Select a lighting condition with reference to the following table:

Display	Lighting Condition
2 SEC (KEY) to 10 SEC (KEY)	When  dial or a key is pressed, the LCD and keys light up for the set time.
CONTINUOUS	The LCD and keys light up continuously.
OFF	The LCD and keys do not light.

Remark Default: Key, 5 seconds



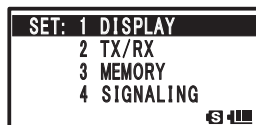



- 7 Press  to save the lighting condition, and exit the Set mode.



Selecting a Display Language

You can select a display language from Japanese and English.

Enter the Set mode:



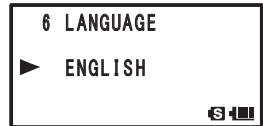



- 1 Press and hold  for over 1 second.
 - 2 Turn  to select [1 DISPLAY].
 - 3 Press .
 - 4 Turn  to select [6 LANGUAGE].
 - 5 Press .
 - 6 Turn  to select a language.
Select [JAPANESE] or [ENGLISH].
- Remark** Default: Japanese
- 7 Press  to save the selected display language, and exit the Set mode.



Adjusting the LCD Contrast Level

You can adjust the LCD contrast level.

Enter the Set mode:



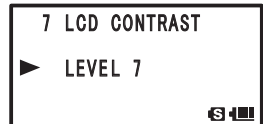
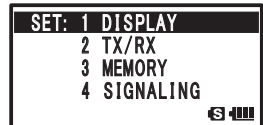



- 1 Press and hold  for over 1 second.
 - 2 Turn  to select [1 DISPLAY].
 - 3 Press .
 - 4 Turn  to select [7 LCD CONTRAST].
 - 5 Press .
 - 6 Turn  to select a contrast level.
Select from among LEVEL 1 (LIGHT) to LEVEL 15 (DARK).
- Remark** Default: LEVEL 7
- 7 Press  to save the selected contrast, and exit the Set mode.



Adjusting the LCD Backlight and Keypad Key Light Brightness Level

You can adjust the brightness level of the LCD backlight and keypad key light.

Enter the Set mode:



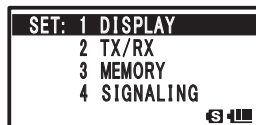

- 1 Press and hold  for over 1 second.
 - 2 Turn  to select [1 DISPLAY].
 - 3 Press .
 - 4 Turn  to select [8 LCD DIMMER].
 - 5 Press .
 - 6 Turn  to select a brightness level.
You can select from LEVEL 1 (DARK) to LEVEL 6 (BRIGHT).
- Remark** Default: LEVEL 6
- 7 Press  to save the selected display brightness level, and exit the Set mode.



Changing the Opening Message Displayed Immediately after Power-on

You can select the message displayed under the “YAESU” logo from among four types: “no message”, “power supply voltage”, “message comprising up to 16 characters”, and “callsign”.

Enter the Set mode:

- 1 Press and hold  for over 1 second.
- 2 Turn  to select [1 DISPLAY].
- 3 Press .
- 4 Turn  to select [9 OPENING MESSAGE].
- 5 Press .

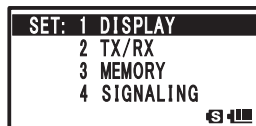

Set Mode

- 6 Turn  to select the display method.

Select a message type with reference to the following table:

Remark Default: CALLSIGN



Display	Display Condition
NORMAL	The YAESU logo appears immediately after power-on.
OFF	Immediately after power-on, the reception frequency, etc. appear without displaying an opening message.
DC	The power supply voltage and time appear immediately after power-on.
MESSAGE	A message comprising up to 16 characters appears immediately after power-on. Pressing  displays the message registration screen. Enter a message to be displayed following the procedure described in "Assigning a Name to a Memory Channel" (See page 47).
CALLSIGN	Your callsign appears immediately after power-on.







- 7 Press  to save the selected display method, and exit from the Set mode.

Measuring the Battery Voltage and the Transceiver Temperature Power Supply Voltage Measurement Function/Temperature Measurement Function



You can measure the battery voltage and the temperature inside the transceiver. When the optional external power supply adapter with a cigarette plug (SDD-13) is connected, the power supply voltage of this adapter is measured.

Enter the Set mode:

- Press and hold  for over 1 second.
- Turn  to select [1 DISPLAY].
- Press .
- Turn  to select [10 SENSOR INFO].
- Press .

The voltage and temperature appear on the LCD.

Remark When the temperature appears on the LCD, pressing  toggles the unit of temperature display between °C and °F.

- Press .
- Press  to exit from the Set mode.

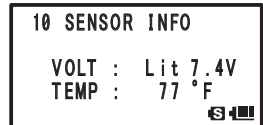
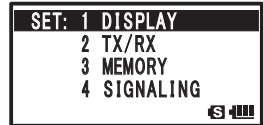









Tips

- The display changes as follows depending on the type of the power supply used.
 Battery pack: "Lit"
 Battery case: "Dry"
 External power supply adapter: "Ext"
- During mono band reception, the voltage can be displayed on the LCD constantly (See page 27).
- This function displays the temperature inside the transceiver.
- In a situation where the temperature inside of the transceiver does not rise (e.g., standby reception), you can know the approximate outside temperature from the temperature displayed on the LCD.

Changing the Display Pattern of the PO Meter

You can select a display pattern of the S/PO meter from among four types.

Enter the Set mode:

- 1 Press and hold  for over 1 second.
 - 2 Turn  to select [1 DISPLAY].
 - 3 Press .
 - 4 Turn  to select [11 S-METER SYMBOL].
 - 5 Press .
 - 6 Turn  to select a display pattern.

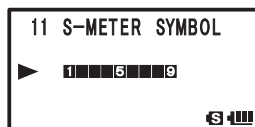
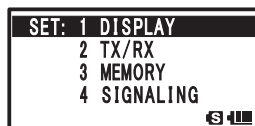
- Remark** Default: 
- 7 Press  to save the selected display pattern, and exit from the Set mode.





Switching between AM Antennas

You can switch antennas when listening to AM broadcast stations.
 For details, see "Switching between AM Antennas" on page 33.

Reducing receiver sensitivity Attenuator (ATT) Function





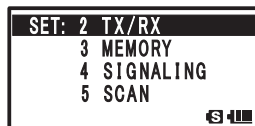

If the signal from the remote station is too strong or, a strong signal is present nearby that interferes with reception, use the attenuator (ATT) function.

Enter the Set mode:

- 1 Press and hold  for over 1 second.
- 2 Turn  to select [2 TX/RX].
- 3 Press .



Set Mode

- Turn  to select [1 MODE].
 - Press .
 - Turn  to select [2 ANTENNA ATT].
 - Press .
 - Turn  to select [ON].
- Remark** Default: OFF
- Press  to save the attenuator function setting, and exit the Set mode.











Tip

- The amount of attenuation by the attenuator (ATT) is about 10 dB.

Setting the transmission modulation level

You can set the transmission modulation level to half of its usual level.
Set [OFF] for normal amateur operation.

Enter the Set mode:

- Press and hold  for over 1 second.
 - Turn  to select [2 TX/RX].
 - Press .
 - Turn  to select [1 MODE].
 - Press .
 - Turn  to select [3 HALF DEVIATION].
 - Press .
 - Turn  to select [ON].
- Remark** Default: OFF
- Press  to save the transmission modulation level is set, and exit the Set mode.

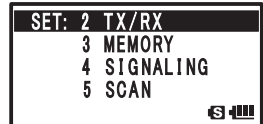















Changing the mode manually

Manually switch to an optimum mode (radio wave type) according to the frequency band. For more details, see “Changing the Mode Manually” on page 38.

Switching between digital and analog mode

You can set digital and analog mode switching and digital transmission mode.





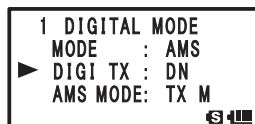
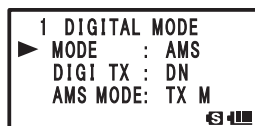
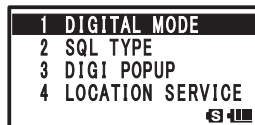
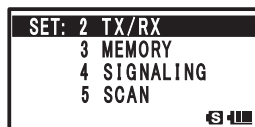





Enter the Set mode:

- 1 Press and hold  for over 1 second.
- 2 Turn  to select [2 TX/RX].
- 3 Press .
- 4 Turn  to select [2 DIGITAL].
- 5 Press .
- 6 Turn  to select [1 DIGITAL MODE].
- 7 Press .
- 8 Turn  to select [MODE].
- 9 Press .
- 10 Turn  to select your desired mode.
 DIGITAL: Transmit and receive in the digital mode.
 ANALOG: Transmit and receive in the analog mode.
 AMS (Automatic Mode Select):
 Tune to the transmission and reception mode of the remote station from which a signal is automatically received.
- 11 Press .
- 12 Turn  to select [DIGI TX].
- 13 Press .
- 14 Turn  to select a reception mode.
 DN: Usual digital communication mode. Conversation is infrequently interrupted even under low power level.
 VW: (Voice Wide) Full rate high quality sound mode This is the transmission function to prioritize the sound quality when the communication condition of the remote station is relatively good.
- 15 Press  to save the setting and exit the Set mode.



Setting the AMS transmission mode

When operating in the AMS function, the transmit mode may be selected:

- 1 Press and hold  for over 1 second.
- 2 Turn  to select [2 TX/RX].
- 3 Press .
- 4 Turn  to select [2 DIGITAL].
- 5 Press .
- 6 Turn  to select [1 DIGITAL MODE].
- 7 Press .
- 8 Turn  to select [AMS MODE].
- 9 Press .
- 10 Turn  to select the AMS transmit mode.

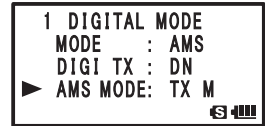
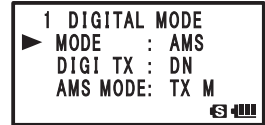
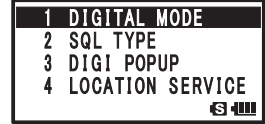
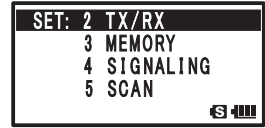

TX M: The operating mode is automatically selected from four communication modes to match the received signal. Pressing the Microphone [PTT] momentarily, toggles between the Digital and Analog communication modes.

TX FM: The RX mode is automatically selected from the four communication modes to match the received signal. The TX mode is automatically changed to the “FM” mode.

TX DN: The RX mode is automatically selected from the four communication modes to match the received signal. The TX mode is automatically changed to the “DN” mode.

TX VW: The RX mode is automatically selected from the four communication modes to match the received signal. The TX mode is automatically changed to the “VW” mode.

AUTO: The RX and TX operating mode is automatically selected from the four communication modes to match the received signal.

- Remarks**
- Default: TX M
 - Blink “I” : TX M
 - Blink “IOO” : TX FM / TX DN / TX VW















The OO symbol display differs according to the received signal.

- 11 Press  to save the setting and exit the Set mode.

Setting the squelch type for the digital mode

You can set the squelch type for the digital mode.

Enter the Set mode:

- 1 Press and hold  for over 1 second.
- 2 Turn  to select [2 TX/RX].
- 3 Press .
- 4 Turn  to select [2 DIGITAL].
- 5 Press .
- 6 Turn  to select [2 SQL TYPE].
- 7 Press .
- 8 Turn  to select [SQL TYPE].
- 9 Press .
- 10 Turn  to select a squelch type.
 - OFF: Voice is always output upon receiving a digital signal from a Yaesu transceiver.
 - CODE: Voice is output only when receiving a signal with a corresponding SQL CODE.
 - BREAK: Voice is output regardless of any squelch code when the remote station transmits with BREAK set.
- 11 Press .
- 12 Turn  to select [SQL CODE].
- 13 Press .
- 14 Turn  to enter a code.



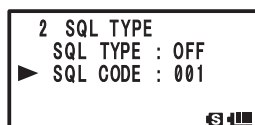
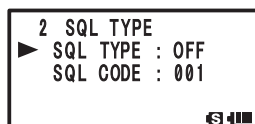
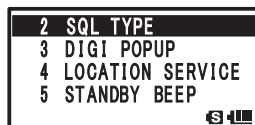
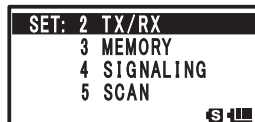

You can enter SQL CODE of 126 types from 001 to 126.
- 15 Press  to save the SQL CODE setting and exit the Set mode.



Setting the pop up time of the remote station information

You can set the time duration to display the remote station information, such as call sign, on the LCD.

Enter the Set mode:

- 1 Press and hold  for over 1 second.
- 2 Turn  to select [2 TX/RX].
- 3 Press .
- 4 Turn  to select [2 DIGITAL].
- 5 Press .

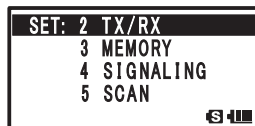

Set Mode

6 Turn  to select [3 DIGI POPUP].

7 Press .

8 Turn  to select the display method.

OFF: Does not display the remote station information.

BND2s to 60s: Set the time to display the remote station information (2 to 60 seconds).

BNDCNT: Always display the remote station information.

Remark Default: 10 seconds

9 Press  to save the pop up time setting and exit the Set mode.



Setting the Standby Beep

When communicating in a digital mode, a beep is sounded after the end of the other stations transmission.

1 Press and hold  for over 1 second.

2 Turn  to select [2 TX/RX].

3 Press .

4 Turn  to select [2 DIGITAL].

5 Press .

6 Turn  to select [5 STANDBY BEEP].

7 Press .

8 Turn  to select [OFF]/[ON].

OFF: Disable the STANDBY BEEP feature.

ON: Enable the STANDBY BEEP feature.

Remark Default: ON



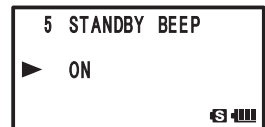
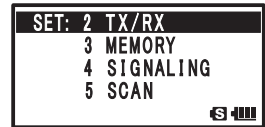





9 Press  to exit from the Set mode.



Displaying the version of the DSP program

You can check the DSP program version of the built in digital unit of the transceiver.

First enter the digital mode, and then enter the Set mode:



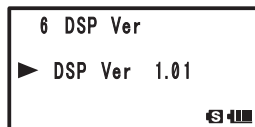
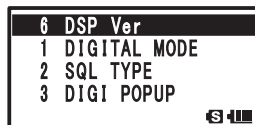
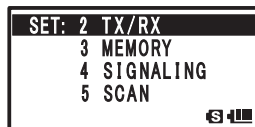





- 1 Press and hold  for over 1 second.
 - 2 Turn  to select [2 TX/RX].
 - 3 Press .
 - 4 Turn  to select [2 DIGITAL].
 - 5 Press .
 - 6 Turn  to select [6 DSP Ver].
 - 7 Press .
- The version of the DSP program appears on the LCD.
- 8 Press  to exit from the Set mode.



Adjusting the microphone sensitivity — Microphone Gain

You can adjust the input level of the built-in microphone or an optional external microphone.

Enter the Set mode:

- 1 Press and hold  for over 1 second.
 - 2 Turn  to select [2 TX/RX].
 - 3 Press .
 - 4 Turn  to select [3 AUDIO].
 - 5 Press .
 - 6 Turn  to select [1 MIC GAIN].
 - 7 Press .
 - 8 Turn  to select a microphone sensitivity level.
Select a microphone gain level from the following:
LEVEL 1 (Lowest sensitivity) to LEVEL 9 (Highest sensitivity)
- Remark** Default: LEVEL 5
- 9 Press  twice.
The selected microphone gain level is set.

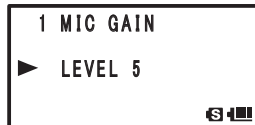
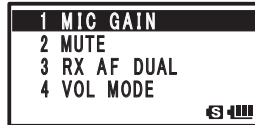
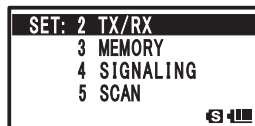

Set Mode

10 Press  to exit the Set mode.

Tips

- Increasing the microphone gain excessively can distort the sound or pick up the surrounding noise, impairing intelligibility.
- Be sure to adjust the microphone gain whenever you change microphones.

Muting Voice

In the dual reception mode, the audio being received on the non-operating band is muted when a signal is heard on the operating band.



For more details, see “Muting Audio” on page 35.

Simultaneously radio broadcast reception









Set the mute time of the simultaneous broadcast reception.

For more details, see “AF-DUAL Function” for simultaneously monitoring the amateur frequency while listening to the broadcast radio.



Changing the sound volume setting method

You can set the sound volume adjustment mode to be automatically canceled after about 3 seconds, after pressing  and then adjusting the sound volume with .

Enter the Set mode:

- 1 Press and hold  for over 1 second.
- 2 Turn  to select [2 TX/RX].
- 3 Press .
- 4 Turn  to select [3 AUDIO].
- 5 Press .
- 6 Turn  to select [4 VOL MODE].
- 7 Press .
- 8 Turn  to select [AUTO BACK].

Remark Default: NORMAL

Tip Usually adjust the sound volume by turning  while pressing . If the [AUTO BACK] is selected, the sound volume adjustment mode will be automatically canceled after you have pressed  to enter the sound volume adjustment mode and return to the frequency display screen.



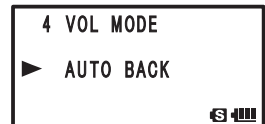
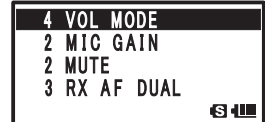
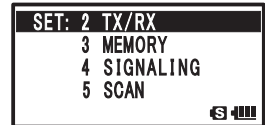



- 9 Press  to exit the Set mode.



Setting memory bank link

You can link multiple registered memory banks, and also recall a frequently used memory bank immediately

Enter the Set mode:

- 1 Press and hold  for over 1 second.
- 2 Turn  to select [3 MEMORY].
- 3 Press .
- 4 Turn  to select [1 BANK LINK].
- 5 Press .
- 6 Turn  to select a memory bank to link.
- 7 Press .

The cursor moves to the position (such as BANK1) to set link.

- 8 Turn  to select [ON].

Remark Default: OFF

- 9 Press .

- 10 Also set link to other memory banks.

Set link to each memory bank from memory bank 1 through memory bank 24 by repeating step 6 to 9.

- 11 Press .

The memory bank link is set.

- 12 Press .

Exits from the Set mode.

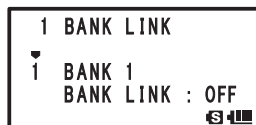
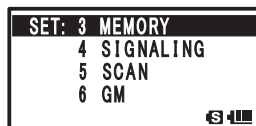

Assigning a name to a memory bank

A memory bank can be assigned a name with up to 16 characters.

For more details, see “Assigning Name to Memory Bank” on page 49.

Assigning a name to a memory channel







Memory channels and home channels may be assigned a name (memory tag) such as a callsign or broadcast station name.

For more details, see “Using Memory Tag” on page 46.

Prohibiting registration to memory channel Memory Channel Protect Function

A memory channel may be protected so that a new frequency or memory channel tag name cannot be registered to it.

Enter the Set mode:

- 1 Press and hold  for over 1 second.
- 2 Turn  to select [3 MEMORY].
- 3 Press .
- 4 Turn  to select [4 MEMORY PROTECT].
- 5 Press .
- 6 Turn  to select [ON].

Any registration to the memory channel is prohibited.

Remark Default: OFF

- 7 Press  to save the memory channel protect, and exit the Set mode.

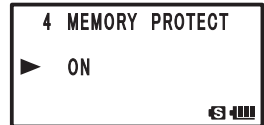
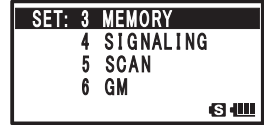

Setting memory skip function

Set the scan method for scanning memory channels.







For more details, see “Specifying a Skip/Selected Memory Channel” on page 60.

Registering to a memory channel with the lowest memory channel number

Memory Channel Write Function

When registering to a memory channel, you can display an unregistered memory channel with the lowest memory channel number.

Enter the Set mode:

- 1 Press and hold  for over 1 second.
- 2 Turn  to select [3 MEMORY].
- 3 Press .
- 4 Turn  to select [6 MEMORY WRITE].
- 5 Press .
- 6 Turn  to select [LOWER].

A memory channel with the lowest memory channel number appears on the LCD.

Remark Default: NEXT

- 7 Press  to set the memory channel registration to the lowest unregistered memory channel number, and exit from the Set mode.

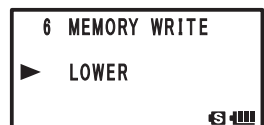
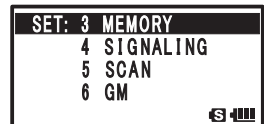

Notifying a call from a remote station by the bell

Notifies you of a call from a remote station by the bell.
See “Notification of a Call from a Remote Station by the Bell” on page 89.







Selecting a DCS code

Select the DCS code from 104 codes from 023 to 754.
For more details, see “Setting a DCS Code” on page 86.

Transmit and receive a DCS Code with an inverted phase DCS INVERSION Function

You can transmit and receive a DCS code with an inverted phase when using the digital code squelch function.

Enter the Set mode:

- 1 Press and hold  for over 1 second.
- 2 Turn  to select [4 SIGNALING].
- 3 Press .
- 4 Turn  to select [3 DCS INVERSION].
- 5 Press .
- 6 Turn  to select a phase.

When a phase is selected for the reception side, the phase for transmission side is automatically determined.

Reception: [Homeomorphic], [Both Phase],
[Inverted Phase], [Homeomorphic],
[Both Phase], [Inverted Phase]

Transmission: [Homeomorphic], [Inverted Phase],
[Inverted Phase], [Inverted Phase],
[Homeomorphic], [Homeomorphic]

Remark Default: Reception [Homeomorphic], Transmission [Homeomorphic]

- 7 Press .

The phase of DCS code is set, and exits from the Set mode.

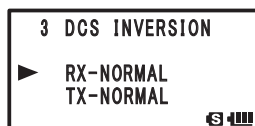
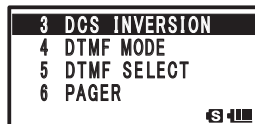
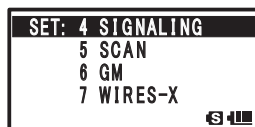

Setting the transmission method of the DTMF code

Set the transmission method of the registered DTMF code.

For more details, see “Sending the Registered DTMF Code” on page 80.

Setting DTMF code

The maximum of 16 digit DTMF code can be registered for a telephone number to make a call through the public telephone line from a phone patch.

For more details, see “Using DTMF Function” on page 79.

Calling only a specific station

New Pager Function

When using transceivers with your friends, specifying personal codes allows only a specific station to be called.







For more details, see “Calling Only a Specific Station New Pager Function” on page 90.

Enabling no-communication squelch function

PR FREQUENCY Function

You can set a no-communication squelch frequency in steps of 100 Hz within the range from 300 Hz to 3000 Hz.

Enter the Set mode:

- 1 Press and hold  for over 1 second.
- 2 Turn  to select [4 SIGNALING].
- 3 Press .
- 4 Turn  to select [7 PR FREQUENCY].
- 5 Press .
- 6 Turn  to tune in to a frequency.

Select no-communication squelch frequency in steps of 100 Hz.

Remark Default: 1600 Hz



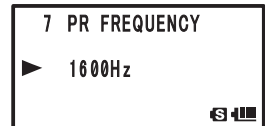
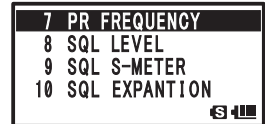
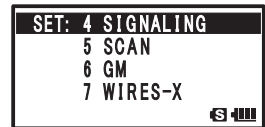



- 7 Press  to set the no-communication squelch function, and exit the Set mode.



Adjusting the squelch level — SQL LEVEL Function

You can set squelch level to mute the raspy noise heard.





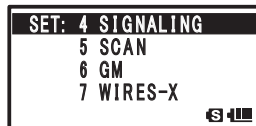

Enter the Set mode:

- 1 Press and hold  for over 1 second.
 - 2 Turn  to select [4 SIGNALING].
 - 3 Press .
 - 4 Turn  to select [8 SQL LEVEL].
 - 5 Press .
 - 6 Turn  to select a squelch level.
Select from among LEVEL 0 to LEVEL 15.
The higher the squelch level, the greater the noise reduction.
- Remark** Default: LEVEL 1
- 7 Press  to save the selected squelch type, and exit the Set mode.



Setting the signal strength to output sound S Meter Squelch Function

You can set A-Band and B-Band individually to output the sound only when receiving a signal stronger than signal strength level set to the S-Meter Level.

- 1 Select a band as an operating band.
 - 2 Press and hold  for over 1 second to enter the Set mode.
 - 3 Turn  to select [4 SIGNALING].
 - 4 Press .
 - 5 Turn  to select [9 SQL S-METER].
 - 6 Press .
 - 7 Turn  to select a setting value.
Select a S-Meter level with reference to the table shown below.
- Remark** Default: OFF
- 8 Press  to save the selected S-Meter level, and exit the Set mode.

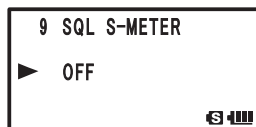
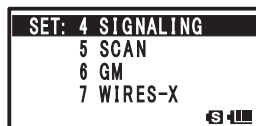

Set Mode

Display	S-Meter Display	Operating Status
OFF	No display	S-Meter squelch function is OFF. (By default, S-Meter squelch function is set to OFF.)
Level 1		Outputs the sound of signal stronger than the S-Meter level 1.
Level 2		Outputs the sound of signal stronger than the S-Meter level 2.
Level 3		Outputs the sound of signal stronger than the S-Meter level 3.
Level 4		Outputs the sound of signal stronger than the S-Meter level 4.
Level 5		Outputs the sound of signal stronger than the S-Meter level 5.
Level 6		Outputs the sound of signal stronger than the S-Meter level 6.
Level 7		Outputs the sound of signal stronger than the S-Meter level 7.
Level 8		Outputs the sound of signal stronger than the S-Meter level 8.
Level 9		Outputs the sound of signal stronger than the S-Meter level 9.

Setting the squelch type for transmission and reception SQL EXPANTION FUNCTION

Squelch types set beforehand can function separately for transmission and reception.

Enter the Set mode:

- 1 Press and hold for over 1 second.
- 2 Turn to select [4 SIGNALING].
- 3 Press .
- 4 Turn to select [10 SQL EXPANTION].
- 5 Press .
- 6 Turn to select [ON].

ON: Use separate squelch for transmission and reception.
OFF: Use the same squelch for transmission and reception.

Remark Default: OFF

- 7 Press to save the separate squelch setting, and exit the Set mode.

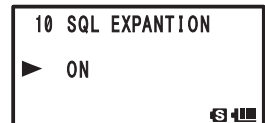
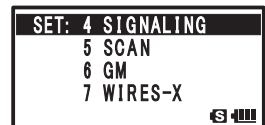

Setting the type of tone squelch

Set the tone squelch to open the squelch only when a signal containing the specified frequency tone is received.

For more details, see “Using the Tone Squelch Function” on page 84.

Selecting a tone frequency











Select the tone frequency from 50 types between 67.0 MHz and 254.1 MHz.

For more details, see “Setting a Tone Frequency” on page 85.

Setting the sound and speed during tone search Tone Search Function

Sound can be muted during tone search. The operation speed of the tone search can also be changed.

Enter the Set mode:



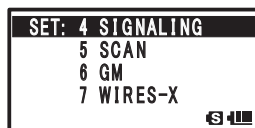



- 1 Press and hold  for over 1 second.
- 2 Turn  to select [4 SIGNALING].
- 3 Press .
- 4 Turn  to select [13 TONE-SRCH].
- 5 Press  twice.
- 6 Turn  to select MUTE to [ON].
Remark Default: ON
- 7 Press .
- 8 Turn  to select [SPPED].
- 9 Press .
- 10 Turn  to select SPEED to [Rapid].
Remark Default: FAST
- 11 Press  to save the Tone Search setting and exit the Set mode.



ON/OFF for the Weather Alert Feature

Setting the Weather Alert Feature, used for notifying storms and hurricanes, ON or OFF.

Enter the Set mode:

- 1 Press and hold  for over 1 second.
- 2 Turn  to select [4 SIGNALING].
- 3 Press .
- 4 Turn  to select [14 WX ALERT].
- 5 Press .
- 6 Turn  to select [ON].

ON: Enables the Weather Alert Feature.

OFF: Disables the Weather Alert Feature.







Remark Default: OFF

- 7 Press  to save the Weather Alert ON or OFF setting, and exit the Set mode

Setting the surveillance interval time for priority channels DW TIME Function

When the dual reception function is active, the interval for monitoring the signal of the priority channel can be set.

Enter the Set mode:

- 1 Press and hold  for over 1 second.
- 2 Turn  to select [5 SCAN].
- 3 Press .
- 4 Turn  to select [1 DW TIME].
- 5 Press .
- 6 Turn  to select the monitoring interval.

Interval can be selected from 0.1 SEC to 10 SEC.

Remark Default: 5 seconds



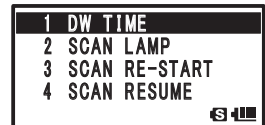
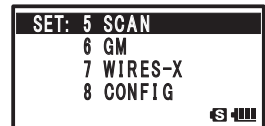



- 7 Press  to save the priority memory channel monitoring interval setting and exit the Set mode.



Turning illumination off when scanning stops SCAN LAMP Function

You can set the backlight of LCD to turn ON or OFF when a signal is received during scanning.

Enter the Set mode:



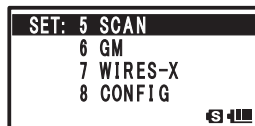



- 1 Press and hold  for over 1 second.
 - 2 Turn  to select [5 SCAN].
 - 3 Press .
 - 4 Turn  to select [2 SCAN LAMP].
 - 5 Press .
 - 6 Turn  to select [OFF].
ON: The LCD backlight will light when a signal is received.
OFF: The LCD backlight will not light when a signal is received.
- Remark** Default: ON
- 7 Press  to save the backlight ON or OFF setting when scanning stops, and exit the Set mode.



Setting the time to resume scan SCAN RE-START Function

You can set the time to resume scanning after a signal is received during scanning.

Enter the Set mode:

- 1 Press and hold  for over 1 second.
 - 2 Turn  to select [5 SCAN].
 - 3 Press .
 - 4 Turn  to select [3 SCAN RE-START].
 - 5 Press .
 - 6 Turn  to select the time to resume scanning.
Select from 0.1 SEC to 10 SEC.
- Remark** Default: 2 seconds
- 7 Press  to set the resume scanning time, and exit the Set mode.

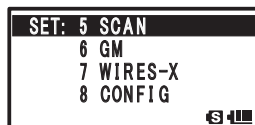

Selecting a reception method when scanning stops













Set the reception method for when scanning stops.

For more details, see “Selecting a Reception Method When Scanning Stops” on page P. 59.

Setting the range for SCAN

You can set the frequency range for scanning with the SCAN Function.

Enter the Set mode:

- 1 Press and hold  for over 1 second.
- 2 Turn  to select [5 SCAN].
- 3 Press .
- 4 Turn  to select [5 SCAN WIDTH].
- 5 Press .
- 6 Turn  to select [VFO].
- 7 Press .
- 8 Turn  to select the range for scanning.
Specify the scanning range with reference to the next list.
- 9 Press .
- 10 Turn  to select [MEMORY].
- 11 Press .
- 12 Turn  to select the range for scanning.

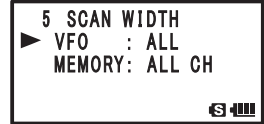
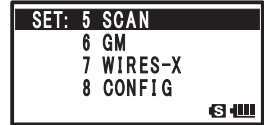

Mode	Display*	Operation Status
VFO Mode	ALL	Scans all bands within the range from the current frequency to 108-999 MHz.
	BAND	Scans the current band (see the table on the next page) starting with the current frequency.
Memory Mode	ALL CH	Scans all memory channels (1-900) of the currently selected memory channel. When selected memory channels are specified, all of them are scanned (See page 59).
	BAND	Scans only the memory channels to which frequencies in the same frequency band*1 are registered. When the selected memory channels are specified, scans only the selected memory channels to which frequencies in the same frequency band*1 are registered (See page 61).







*1 For the relationship between frequency bands and reception frequencies, see the table at the bottom of page 28.

- 13 Press  to save the range for scanning, and exit the Set mode.

Turning off the power automatically APO Function

The transceiver may be set to turn off automatically if there is no operation for a certain period of time.

Enter the Set mode:

- 1 Press and hold  for over 1 second.
- 2 Turn  to select [8 CONFIG].
- 3 Press .
- 4 Turn  to select [1 APO].
- 5 Press .
- 6 Turn  to set the time.

Set the time for the transceiver to turn off automatically in steps of 30 minutes.

OFF/30 MIN/1 HOUR to 12 HOURS

Remark Default: OFF

- 7 Press  to save the auto power-off function setting, and exit the Set mode. The transceiver will be automatically turned off if there is no operation for the set period of time.

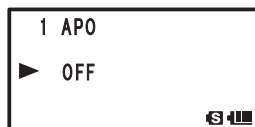
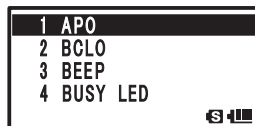
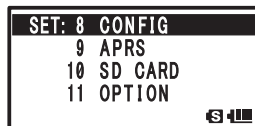

Tips



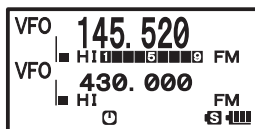



- When the auto power-off function is active, the  icon appears on the LCD.
- Once the time for automatic power-off is set, it is retained until "OFF" is selected in step 6 of the above-mentioned procedure. (The next time you turn the transceiver on, if you perform no operation for the set period of time, the transceiver will automatically turn itself off.)



Preventing accidental transmission Busy Channel Lockout (BCLO) Function

You can prevent accidental transmission during signal reception.

Enter the Set mode:



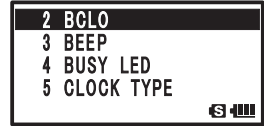
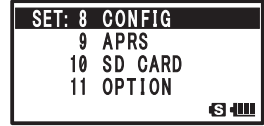





- 1 Press and hold  for over 1 second.
 - 2 Turn  to select [8 CONFIG].
 - 3 Press .
 - 4 Turn  to select [2 BCLO].
 - 5 Press .
 - 6 Turn  to select [ON].
- Remark** Default: OFF
- 7 Press  to save the BCLO function setting, and exit the Set mode.



Muting the key operation confirmation tone

The operation confirmation sound (beep sound) that is heard when keys are operated, or when scanning reaches the end of a frequency band, can be turned off.





Enter the Set mode:

- 1 Press and hold  for over 1 second.
- 2 Turn  to select [8 CONFIG].
- 3 Press .
- 4 Turn  to select [3 BEEP].
- 5 Press .
- 6 Turn  to select [SELECT].
- 7 Press .
- 8 Turn  to select [OFF].

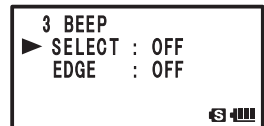
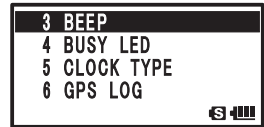
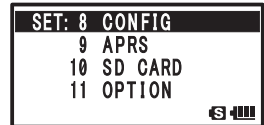
Remarks Default: KEY&SCAN

Display	Description
OFF	Mutes the beep.
KEY&SCAN	Emits a beep when a key is operated or scanning stops.
KEY	Emits a beep when a key is pressed.











- 9 Press .
- 10 Turn  to select [EDGE].
- 11 Press .
- 12 Turn  to select [OFF].
- 13 Press  to exit from the Set mode.

Turning off the BUSY Indicator

When you listen to the radio continuously or when the remaining battery level has become low, you can turn off the BUSY indicator to save battery power consumption.

Enter the Set mode:



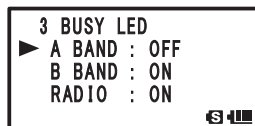
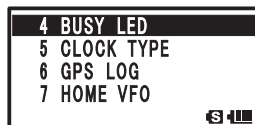
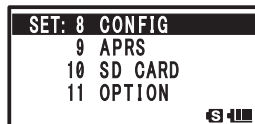



- 1 Press and hold  for over 1 second.
 - 2 Turn  to select [8 CONFIG].
 - 3 Press .
 - 4 Turn  to select [4 BUSY LED].
 - 5 Press .
 - 6 Turn  to select a band.
Select a band from among [A BAND], [B BAND], and [RADIO].
 - 7 Press .
 - 8 Turn  to select [OFF].
Remark Default: ON
 - 9 Press .
- The BUSY indicator is turned off, and exits from the Set mode.



Setting the clock shift for the micro computer Clock Type Function

The micro computer Clock Shift function may be set to reduce internal high frequency spurious interference signals. Select [A] for normal use.

Enter the Set mode:



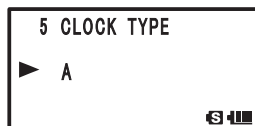
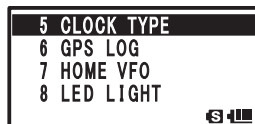
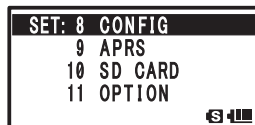



- 1 Press and hold  for over 1 second.
- 2 Turn  to select [8 CONFIG].
- 3 Press .
- 4 Turn  to select [5 CLOCK TYPE].
- 5 Press .
- 6 Turn  to select a clock type.
A: The Clock Shift function is automatically turned on or off.
B: The Clock Shift function is continually active.
Remark Default: A
- 7 Press  to save the Clock Type setting, and exit the Set mode.



Setting interval to save GPS position information

Set the interval at which the GPS information of your current position is saved to the microSD memory card.

Enter the Set mode:

- 1 Press and hold  for over 1 second.
- 2 Turn  to select [8 CONFIG].
- 3 Press .
- 4 Turn  to select [6 GPS LOG].
- 5 Press .
- 6 Turn  to select an interval to save GPS position information.
OFF / 1 SEC / 2 SEC / 5 SEC / 10 SEC / 30 SEC / 60 SEC

Information is not recorded to the microSD memory card if OFF is selected.

Remark Default: OFF

- 7 Press  to save the GPS information saving interval setting, and exit the Set mode.

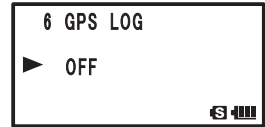
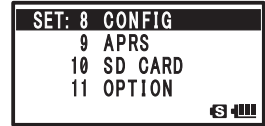







Tips

- Data saved to the microSD memory card is saved in xxx.LOG format.
- Saved data can be viewed with PC applications*.
- * PC applications are not supported by our company.

Permitting Transfer of Home Channel Frequency to VFO

You can use the set operation to transfer home channel frequency information to the VFO.

Enter the Set mode:

- 1 Press and hold  for over 1 second.
 - 2 Turn  to select [8 CONFIG].
 - 3 Press .
 - 4 Turn  to select [7 HOME VFO].
 - 5 Press .
 - 6 Turn  to select Unlock or Lock.
- ENABLE: Turning  in home channel transfers the home channel frequency to VFO.

DISABLE: The home channel frequency cannot be transferred.

Remark Default: ENABLE



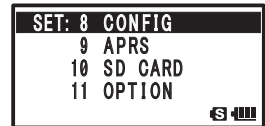



- 7 Press  to save the frequency transfer ENABLE/DISABLE/Unlock setting, and exit the Set mode.



Using the White LED as a Flashlight



The white LED may be used as a flashlight.

Enter the Set mode:

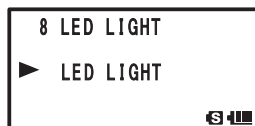
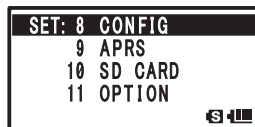





- 1 Press and hold  for over 1 second.
- 2 Turn  to select [8 CONFIG].
- 3 Press .
- 4 Turn  to select [8 LED LIGT].
- 5 Press .
The white LED lights as a flashlight.
- 6 Press .
The LED goes out.
- 7 Press  to exit from the Set mode.



Setting the conditions for locking LOCK Function

Conditions for activating Lock Function, such as keys, , and , can be set.

Enter the Set mode:



- 1 Press and hold  for over 1 second.
- 2 Turn  to select [8 CONFIG].
- 3 Press .
- 4 Turn  to select [9 LOCK].
- 5 Press .
- 6 Turn  to select the keys and switches to lock.

KEY & DIAL: Locks the keys and  on the front of the transceiver.

PTT: Locks .

KEY & PTT: Locks the keys and  on the front of the transceiver.

DIAL & PTT: Locks  and .

ALL: Locks the keys, , and  on the front of the transceiver.

KEY: Locks the keys on the front of the transceiver.

DIAL: Locks .

Remark Default: KEY&DIAL

- 7 Press .



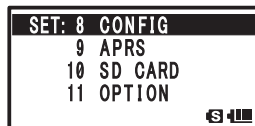



The keys and switches to lock are set, and exits from the Set mode.



Setting the operation of

The function for when  is pressed can be set.



Enter the Set mode:

- 1 Press and hold  for over 1 second.
- 2 Turn  to select [8 CONFIG].
- 3 Press .
- 4 Turn  to select [10 MONI/T-CALL].
- 5 Press .
- 6 Turn  to select the function.

MONI: Pressing  monitors frequency.

T-CALL: Pressing  functions as tone call.

Remark Default: Depends on the transceiver version.



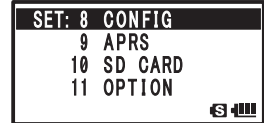











- 7 Press .
- The function for  is set.
- 8 Press  to save the setting and exit the Set mode.



Turning on/off the transceiver at the specified time Timer Function

You can turn the transceiver to turn on/off at the set time. Before using this function, adjust the clock. See “Setting clock time” on page 34.

Enter the Set mode:



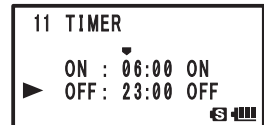
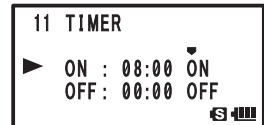
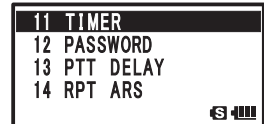
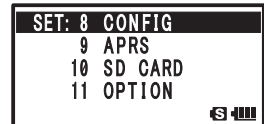







- 1 Press and hold  over 1 second.
- 2 Turn  to select [8 CONFIG].
- 3 Press .
- 4 Turn  to select [11 TIMER].
- 5 Press .
- 6 Turn  to select [ON] or [OFF].
ON: Turns on the transceiver at the specified time.
OFF: Turns off the transceiver at the specified time.
- 7 Press .
- 8 Turn  to specify hours.
- 9 Press .
- 10 Turn  to specify minutes.
- 11 Press .
- 12 Turn  to switch between ON/OFF of the timer.
- 13 Press .
- The timer function is turned on.
- 14 Press  to exit from the Set mode.



Password Function

You can enter a 4-character password to prevent a third party from using your transceiver without permission. Once a password is entered, the transceiver cannot be turned on until the valid password is entered.

Enter the Set mode:



- 1 Press and hold  for over 1 second.
- 2 Turn  to select [8 CONFIG].
- 3 Press .
- 4 Turn  to select [12 PASSWORD].
- 5 Press .
- 6 Press .
- 7 Turn  to enter the first character of the password.
Enter the first character (0-9, A to D, *, and #) of the password.
- 8 Press .
- 9 Repeat steps 7 and 8 to enter the remaining three characters.
- 10 Press .
- 11 Turn  to select [ON].

Remark Default: OFF

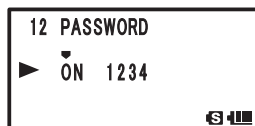
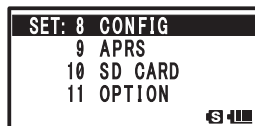
- 12 Press  to save the password setting, and exit the Set mode.



Tips

- To cancel the password function, execute the above-mentioned steps 1 to 5, select "OFF" with , and then press  over 1 second.
- Keypad keys cannot be used to enter the password.
- When the on-timer function is active, the password function is ineffective.

•Turning on the transceiver using a password

- 1 Press and hold  for over 1 second.
The password entry screen appears.
- 2 Enter the password using keypad keys.
Enter the registered 4-character password.
When the valid password is entered, the frequency display screen appears.

Remark When an invalid password is entered, the transceiver is turned off automatically.







Caution

- If you've forget the registered password, carrying out all resetting allows you to turn on the transceiver without entering the password.
- It should be noted that performing all resetting resets (initializes) all information such as the information registered to memory channels and various setting values.
- It is recommended that the password be written down on paper.

Setting the PTT delay time PTT DELAY Function

You can set the time for actual transmission to start after  is pressed.

Enter the Set mode:



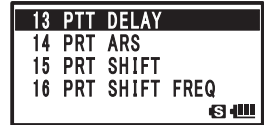
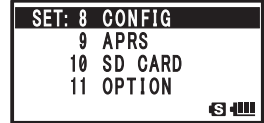



- 1 Press and hold  for over 1 second.
 - 2 Turn  to select [8 CONFIG].
 - 3 Press .
 - 4 Turn  to select [13 PTT DELAY].
 - 5 Press .
 - 6 Turn  to select the time.
OFF/20ms/50ms/100ms/200ms
- Remark** Default: OFF
- 7 Press  to save the PTT delay time setting, and exit the Set mode.



Setting the ARS function RPT ARS Function

You can set the operation of ARS (Tuning in to the repeater frequency automatically enables the repeater).

Enter the Set mode:



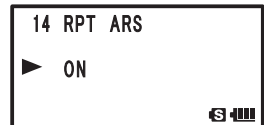
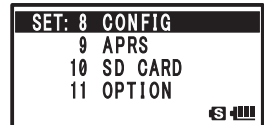



- 1 Press and hold  for over 1 second.
 - 2 Turn  to select [8 CONFIG].
 - 3 Press .
 - 4 Turn  to select [14 RPT ARS].
 - 5 Press .
 - 6 Turn  to select ON/OFF.
ON: ARS is functional.
OFF: ARS is not functional.
- Remark** Default: ON
- 7 Press  to save the ARS function ON/OFF setting, and exit the Set mode.



Setting the direction for repeater shift RPT SHIFT Function

You can set the direction of repeater shift.

Enter the Set mode:



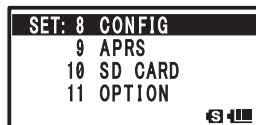





- 1 Press and hold  for over 1 second.
 - 2 Turn  to select [8 CONFIG].
 - 3 Press .
 - 4 Turn  to select [15 RPT SHIFT].
 - 5 Press .
 - 6 Turn  to select the shift direction.
SIMPLEX: Does not shift.
-RPT: Shifts toward lower frequencies.
+RPT: Shifts toward higher frequencies.
- Remark** Default setting differs depending frequency
- 7 Press  to save the repeater shift direction setting, and exit the Set mode.



Setting the range for repeater shift RPT SHIFT FREQ Function

You can set the repeater shift range.

Enter the Set mode:



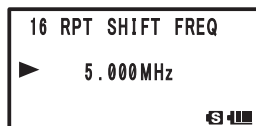
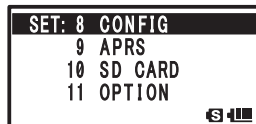



- 1 Press and hold  for over 1 second.
 - 2 Turn  to select [8 CONFIG].
 - 3 Press .
 - 4 Turn  to select [16 RPT SHIFT FREQ].
 - 5 Press .
 - 6 Turn  to select shift range.
The range can be set in steps of 50 kHz between 0.0000 MHz and 150.000 MHz.
Pressing  and then turning  allows you to set frequencies in steps of 1 MHz.
- Remark** Default setting differs depending frequency
- 7 Press  to save the repeater shift range setting, and exit the Set mode.



Disabling reception while no signal is received Reception Save Function

To reduce power consumption, the reception function can be turned off when not receiving a signal.

Enter the Set mode:

- 1 Press and hold  for over 1 second.
- 2 Turn  to select [8 CONFIG].
- 3 Press .
- 4 Turn  to select [17 SAVE RX].
- 5 Press .
- 6 Turn  to select the time.

Select the time for the reception to be turned off automatically.

- 0.2 SEC (1:1) to 1.0 SEC (1:5) (Step: 0.1 sec)
- to 1.0 SEC (1:5) to 10 SEC (1:50) (Step: 0.5 sec)
- to 1.0 sec (1:50) to 60 sec (1:300 sec) step 5 sec
- OFF

Remark Default: 0.2 sec (1:1)

- 7 Press  to save the Reception Save function setting, and exit the Set mode.

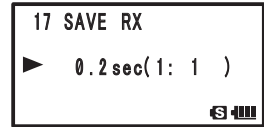
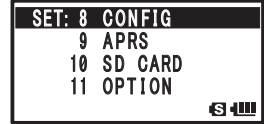

Changing the frequency step manually

Frequency step can be set so that it can be changed manually.

For more details, see “Changing the Frequency Step Manually” on page 37.

Setting clock time



Set the time for the internal clock of this transceiver.

For details, see “Setting clock time” on page 34.





Restricting the continuous transmission time TOT Function

Set the transceiver to automatically return to the receive mode after transmitting continuously for a certain period of time. Accidental transmission of unnecessary signals, and unwanted battery power consumption can be prevented (time-out timer function).

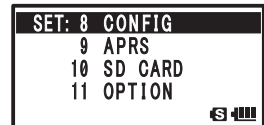
Enter the Set mode:

- 1 Press and hold  for over 1 second.
- 2 Turn  to select [8 CONFIG].
- 3 Press .



- 4 Turn  to select [20 TOT].
- 5 Press .
- 6 Turn  to select the time.
Set the time for the transceiver to automatically return to the reception state in steps of 30 seconds.
OFF/30 SEC to 10 MIN
Remark Default: OFF
- 7 Press  to save the TOT function setting, and exit the Set mode.

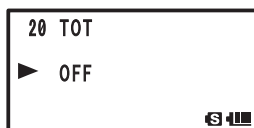







Tips

- When the time-out timer function is active, a beep is emitted when it comes near the set time. About 10 seconds later, the transceiver returns to the reception state.
- Once the time is set, it is retained until "OFF" is selected in step 6 of the above-mentioned procedure.

Setting the frequency selection range for operation in the VFO mode VFO MODE Function

You can set the frequency selection range for operating in the VFO mode.

Enter the Set mode:

- 1 Press and hold  over 1 second.
- 2 Turn  to select [8 CONFIG].
- 3 Press .
- 4 Turn  to select [21 VFO MODE].
- 5 Press .
- 6 Turn  to select a frequency range.
ALL: Switches to the next band when the end of a band is reached.
BAND: Moves to the other end of the band when the end of that band is reached.
Remark Default: BAND
- 7 Press  to save the frequency selection range setting, and exit the Set mode.

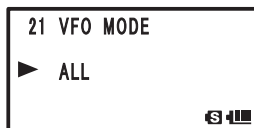
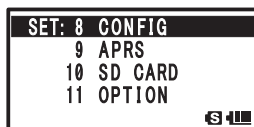









Notification of a call from a remote station by vibration

The vibrator function may be set to notify you of a call from a remote station. For details, see “Notification of Call from the Remote Station by Vibration of the Vibrator” on page 88.

Saving/ Loading data to/from microSD memory card

Settings information can be saved to a microSD memory card, also the saved information can be loaded to the transceiver.

Enter the Set mode:

- 1 Press and hold  over 1 second.
- 2 Turn  to select [10 SD CARD].
- 3 Press .
- 4 Turn  to select [1 BACKUP].
- 5 Press .
- 6 Turn  to select [Write to SD] or [Read from SD].
Write to SD: Saves the setting information of your transceiver to the microSD memory card.
Read from SD: Loads the setting information to your transceiver from the microSD memory card.
Cancel: Stops save or load.
- 7 Press .
[OK?] appears on the LCD.
- 8 Press .
The write or read is performed and [Completed] appears when finished.
- 9 Press  to exit from the Set mode.

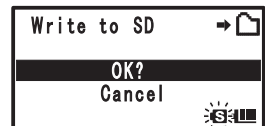
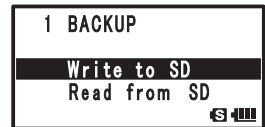
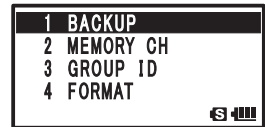
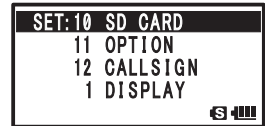



Blinks when writing





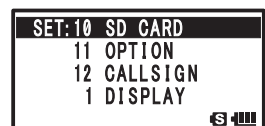

Saving/ Loading memory channel information to/from microSD memory card

Memory channel setting information can be saved to a microSD memory card, or saved information can be loaded to this transceiver.

Enter the Set mode:

- 1 Press and hold  for over 1 second.
- 2 Turn  to select [10 SD CARD].
- 3 Press .



- 4 Turn  to select [2 MEMORY CH].
- 5 Press .
- 6 Turn  to select [Write to SD] or [Read from SD].
Write to SD: A beep is heard and [Completed] appears when writing to SD finished.
Read from SD: A beep is heard when loading from SD finished and the transceiver restarts with the settings read from the microSD memory card. (The operation in step 9 is not required.)
Cancel: Stops save or load.
- 7 Press .
[OK?] appears on the LCD.
- 8 Press .
The write or read is performed and [Completed] appears when finished.
- 9 Press  to exit from the Set mode.

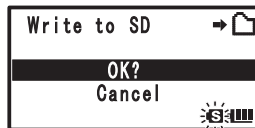
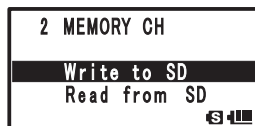
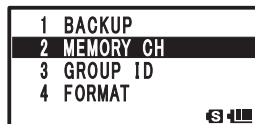







Blinks when writing

Saving/ Loading GROUP ID information to/from microSD memory card

Group ID setting information can be saved to a microSD memory card, or saved information can be loaded to this transceiver.

Enter the Set mode:

- 1 Press and hold  for over 1 second.
- 2 Turn  to select [10 SD CARD].
- 3 Press .
- 4 Turn  to select [3 GROUP ID].
- 5 Press .
- 6 Turn  to select [Write to SD] or [Read from SD].
Write to SD: Saves the Group ID information to your transceiver to the microSD memory card.
Read from SD: Loads the Group ID information to your transceiver from the microSD memory card.
Cancel: Stops save or load.
- 7 Press .
[OK?] appears on the LCD.

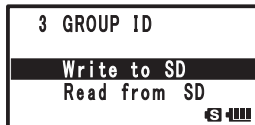
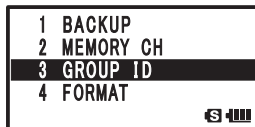
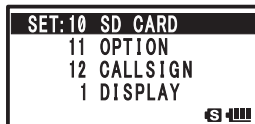

Set Mode

- 8 Press **ENT**.

Write to SD: A beep is heard and [Completed] appears when writing to SD finished.

Read from SD: A beep is heard when loading from SD finished and the transceiver restarts with the settings read from the microSD memory card. (The operation in step 9 is not required.)

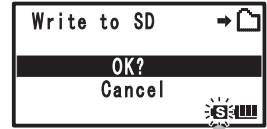

Blinks when writing

- 9 Press **PTT** to exit from the Set mode.

Formatting a microSD memory card

Format a new microSD.

For more details, see “Formatting a microSD memory card” on page 24.

Setting the optional microphone with camera for use

Image size and quality can be set for the optional microphone with camera (MH-85A11U).

Enter the Set mode:

- 1 Press and hold **SET DISP** for over 1 second.
- 2 Turn **DIAL** to select [11 OPTION].
- 3 Press **ENT**.
- 4 Turn **DIAL** to select [1 USB CAMERA].
- 5 Press **ENT**.
- 6 Turn **DIAL** to select [SIZE].
- 7 Press **ENT**.
- 8 Turn **DIAL** to select an image size.
320×240
160×120
- 9 Press **ENT**.
- 10 Turn **DIAL** to select [QUALITY].
- 11 Press **ENT**.
- 12 Turn **DIAL** to select an image quality.
LOW: Low image quality
NORMAL: Intermediate image quality
HIGH: High image quality
- 13 Press **PTT** to exit from the Set mode.

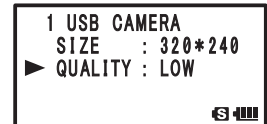
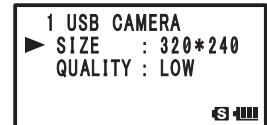
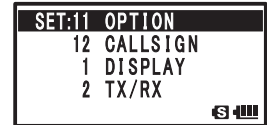



Caution

- If image size is set to large or image quality is set to high, the data transmission time becomes longer.
- The transmission time varies depending on the content of an image.











Registering CALLSIGN

The CALLSIGN used in the digital mode can be registered with up to 10 alphanumeric characters.



Enter the Set mode:

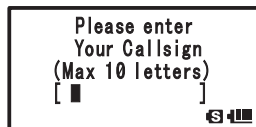

- 1 Press and hold  for over 1 second.
- 2 Turn  to select [12 CALLSIGN].
- 3 Press .
- 4 Enter the characters using keypad keys.

Enter a callsign using keypad keys with reference to the following table.

Numeric key	A, 0 (Alphanumeric)
	1
	ABC2
	DEF3
	GHI4
	JKL5
	MNO6
	PQRS7
	TUV8
	WXYZ9
	0



- Tip**
- Pressing  moves the cursor to the right.
 - Press the  to move the corsor back to the left.
 - Press the  to delete the letter or number at the current cursor position.

- 5 Press .
The cursor moves.
- 6 Repeat steps 4 and 5 to enter the CALLSIGN.
- 7 Press  to save the CALLSIGN setting and exit the Set mode.

Using the transceiver for packet communication

You can perform packet communication with your transceiver by connecting TNC (Terminal Node Controller) using an optional connection cable (CT-44).

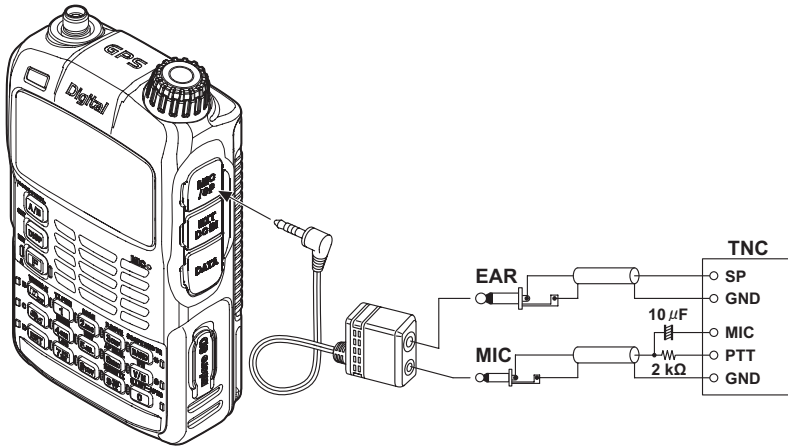

After TNC is connected, set the level of output to TNC by adjusting the sound volume level of your transceiver.

Also adjust the level of input to your transceiver using the output level adjustment volume on the TNC (Input level cannot be adjusted on your transceiver)

Caution

- When sending a vast volume of data, the transmission takes a longer time and the transceiver may be overheated.
If the transmission is continued for a long time, the overheat prevention circuit will operate and the transmission power decreases. If the transmission is continued further, the transmission will be automatically stopped to prevent the transceiver from overheating and consequently malfunctioning. The transceiver will return to the receive mode.
When the transceiver returns to the receive mode after the overheat prevention circuit has operated, turn the transceiver off, or keep it in the receive mode until the temperature cools.

Tips

- Set the Receive Battery Save function to OFF during packet communication by selecting [8 CONFIG] → [17 SAVE RX] in the Set mode.
- The reception can be interfered with a noise generated from PC.
If the transceiver can not receive normally, disconnect it from the PC and reconnect it to the PC using a photocoupler or noise filter.
- To connect the TNC and PC, refer to the TNC instruction manual.

Clone Operation

Data and various settings saved in your transceiver can be copied to another FT1DR/DE transceiver.

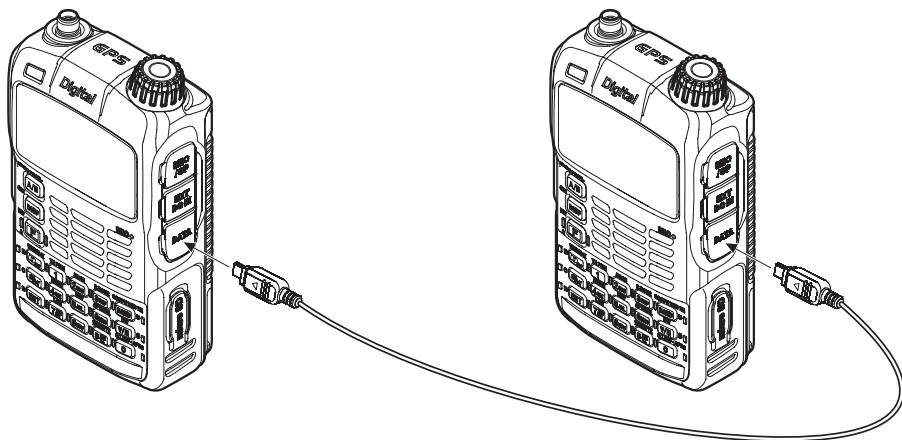

- 1 Turn off the power of both FT1DR/DE transceivers and connect an optional clone cable (CT-168) to the DATA terminal of each transceiver.
- 2 Press while pressing on each transceiver. The two transceivers are turned on and placed in the clone mode.
- 3 Press on the receiving side transceiver and on the transmission side.

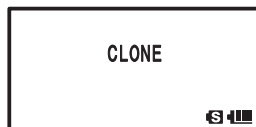

Copying data starts.

When copying starts, the display on the receiving transceiver changes from [--WAIT--] to [--RX--]. When data transmission begins from the sending transceiver, the data transmission indicator appears on the LCD, indicating the data transfer is in progress. The indicator appears on the receiving transceiver, as well when data reception starts.

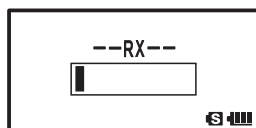
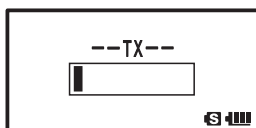

Tips When copying is completed, the reception side transceiver returns to the normal mode. The indication on the LCD of the transmission side transceiver returns from [--TX--] to [CLONE].

- 4 Turn off the power of both transceivers and disconnect the clone cable.

Caution

- When the [ERROR] appears on the LCD during data transfer, copying cannot be completed. Check the clone cable connection, and redo the clone operation from the beginning.
- Time data cannot be copied.

Connecting an external device

Using the DATA terminal, the transceiver can support various functions by setting “GPS”, the internal GPS unit begins outputting the position information data. The position information of the transceiver can be transferred at approximately 1 second intervals to the computer so that the position of the transceiver can be displayed in real-time on programs such as map software.

Tips

- For properties such as communication speed and Input/Output between COM ports.
- For more details, see the Set mode option, [9 APRS] → [17 COM PORT SETTING].

Connecting to a PC

Connecting a PC to the data terminal of the FT1DR/DE using the PC Connection Cable (SCU-18 or SCU-19) accessory will enable data transmission or updating firmware as described below.

a. Transmit position location information received by the FT1DR/DE internal GPS unit.

By setting [OUTPUT] in [17 COM PORT SETTING] of Set mode option [9 APRS] to details on settings, see Set mode option [17 COM PORT SETTING] in the APRS Instruction Manual.

- To show information, software operating with NMEA-0183 specified GGA and RMC sentence is required.

b. FT1DR/DE Firmware Updates

When a new firmware update for the FT1DR/DE is available, go to the YAESU homepage to download the programming data and update the FT1DR/DE to its newest state.

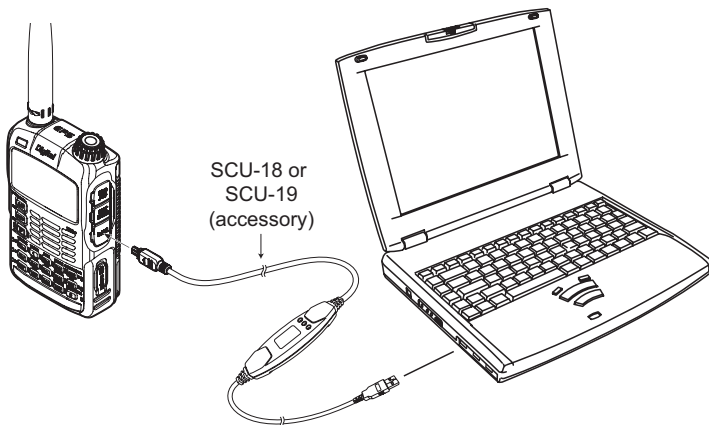

Tip

To use the SCU-18 or SCU-19, install a dedicated driver to the PC. For downloading the dedicated driver and installation manual, please go to the YAESU website homepage (<http://www.yaesu.com>).

Connecting the FT1DR/DE to external devices

Position information data can be exchanged between commercially sold GPS receivers or other external devices by using the optional Data Cable (CT-170) or the Data Cable 2.5Φ (CT-176).

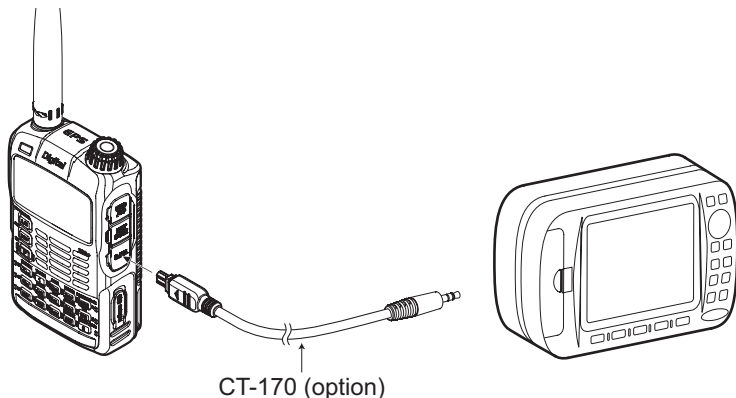

Tip

Connect the Data Cable (CT-170) and the Data Output Cable (CT-176) by referring to the instruction manual for the GPS device to be used, and cable specifications on the next page.

Data Cable (CT-170)

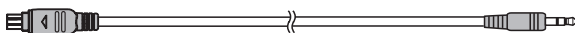

- ⑦ RXD (Serial data input [FT1DR/DE ← External Equipment])
- ⑧ TXD (Serial data output [FT1DR/DE → External Equipment])
- ⑩ GND
- ① RXD (Serial data input [FT1DR/DE ← External Equipment])
- ② TXD (Serial data output [FT1DR/DE → External Equipment])
- ③ GND

Data Cable (2.5Φ) (CT-176)

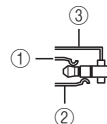
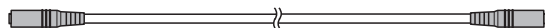
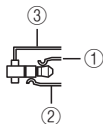

- ① RXD (Serial data input [FT1DR/DE ← External Equipment])
- ② TXD (Serial data output [FT1DR/DE → External Equipment])
- ③ GND
- ① TXD (Serial data output [FT1DR/DE → External Equipment])
- ② RXD (Serial data input [FT1DR/DE ← External Equipment])
- ③ GND

Optional Parts

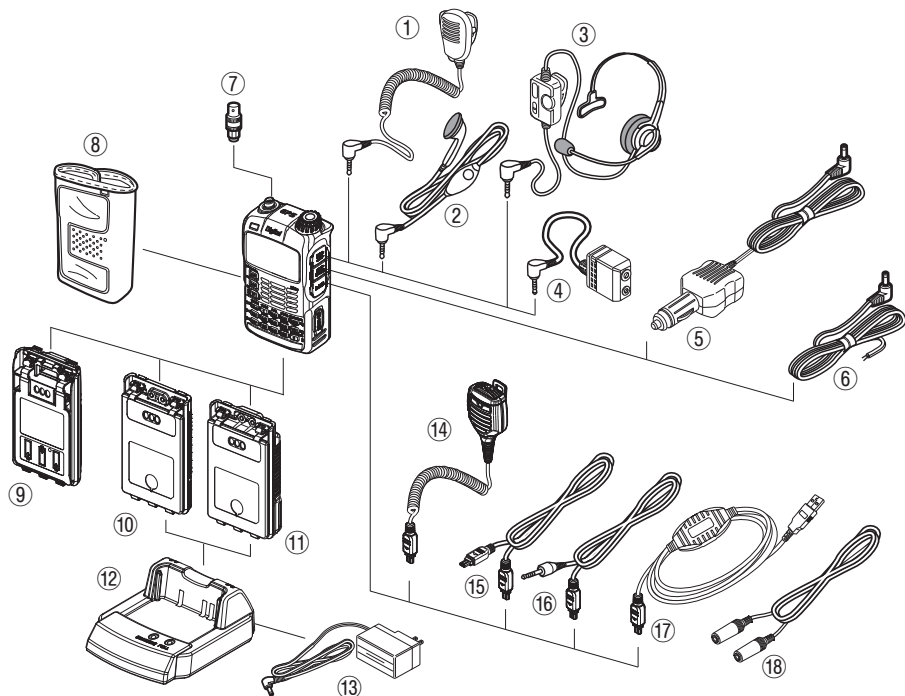

- | | |
|-----------------------------------------------------------|----------------------------------------------------------|
| ① Speaker / Microphone (MH-34B4B) | ⑪ Lithium Ion Battery Packs (FNB-102LI, 7.4 V, 1800 mAh) |
| ② Earpiece Microphone (MH-37A4B) | ⑫ Rapid Charger (CD-41) |
| ③ VOX Headset (SSM-63A) | ⑬ Battery Charger (PA-48B/C/U*) |
| ④ Microphone Adapter (CT-44) | ⑭ Battery Charger (SAD-11B; for USA market) |
| ⑤ DC Cable w/ Noise Filter (SDD-13) (USA/EXP market only) | ⑮ Speaker Microphone with Snapshot camera (MH-85A11U) |
| ⑥ DC Cable (E-DC-6) (USA/EXP market only) | ⑯ Clone Cable (CT-168) |
| ⑦ BNC-to-SMA Adapter (CN-3) | ⑰ Data Cable (CT-170) |
| ⑧ Soft Case (CSC-97) | ⑱ PC Connection Cable (SCU-18 or SCU-19) |
| ⑨ 3x "AA" Cell Battery Case (FBA-39) | ⑲ Data Cable (2.5Φ) (CT-176) |
| ⑩ Lithium Ion Battery Packs (FNB-101LI, 7.4 V, 1100 mAh) | |

* "B" suffix is for use with 120 VAC (Type-A plug), "C" suffix is for use with 230-240 VAC (Type-C plug), and "U" suffix is for use with 230 VAC (Type-BF plug).



Availability of accessories may vary. Some accessories are supplied as standard per local requirements, while others may be unavailable in some regions. Consult your Yaesu Dealer for details regarding these and any newly-available options. Connection of any non-Yaesu approved accessory, should it cause damage, may void the Limited Warranty on this apparatus.

If you suspect malfunction Check the following items before requesting for repair.



The transceiver does not turn on.

- Is the battery is depleted?
 - Charge the battery pack after purchase, and when the transceiver has not been used for a long time.
- Is the battery pack properly set?
 - Refer to "Mounting the battery pack" and securely mount the battery pack.
- Is the external power supply properly connected?
 - When using an external power supply, connect an external power supply adapter with a cigarette lighter plug (SDD-13) or an external power cable (E-DC-6) to this jack.
- Is the voltage of the battery pack or the SDD-13 correct?
 - Be sure that there is a charge left in the battery pack (do not completely discharge). Check that the output voltage of the SDD-13 is approximately 12V.

There is no sound

- Is the level of squelch (or S meter squelch) set too high?
 - Press the Monitor Switch and check that you can hear white noise.
 - Adjust the level of squelch (or S meter squelch) when receiving a weak signal.
- Is the volume low?
 - Turn  clockwise while pressing  to increase the sound volume.
- Is the tone squelch or DCS on?
 - When the tone squelch or DCS is on, the sound is not output until the transceiver receives a signal containing the same tone frequency or DCS code set.

There is no transmission of radio waves.

- Are you pressing the  switch properly?
- Is the PTT lock on?
- Is the Busy TX Block (BCLO function) on?
 - When the Busy TX Block (BCLO Function) is on, transmission cannot be done when receiving a signal even if  is pressed. Wait until signal being received stops and then press .
- Is the transmission frequency on an ham radio band?
 - Transmission cannot be performed on the AM Radio Broadcast Band/ Short Wave Radio Band/ FM Radio Broadcast Band/ Air Band/ Information Radio Band.
- Is the voltage of the battery pack or external power source correct?
 - Check the remaining charge on the battery pack.
 - In addition, using a power supply where voltage drops during transmission will prevent the FT1DR/DE from operating on full capability.

The keys or does not respond.

- Is the Key Lock or DIAL Lock on?







The battery pack cannot be charged or battery power depletes immediately after charging.

- Is the battery pack being charged with a charger specified by Yaesu?
Charge the battery pack using the accessory battery charger (PA-48B or SAD-11B) or the rapid charge cradle (CD-41).
When using an external power supply, use the external power supply adapter with a cigarette lighter plug (SDD-13) or an external power cable (E-DC-6).
- Is the battery pack in use exhausted?
If the "Charging Error" appears on the LCD when charging, there is a chance the battery pack is over discharged. If the error is repetitively displayed after charging the battery pack several times, the battery pack may have reached its service life or defective. Battery packs are consumables. Please replace the battery pack with a new one immediately. Battery packs can be charged and reused up to approximately 300 times.

Depending on the combination for simultaneous reception, there may be internal beats from high frequencies caused by the internal oscillator. This is not a malfunction. (See the calculation formula below: "n" is for the arbitrary integer). Depending on the combination for simultaneous reception, there may be fluctuations in reception sensitivity.

- Reception Frequency = 16 MHz × n multiplicative
- Reception Frequency = 15.6 MHz × n multiplicative
- Reception Frequency = 4.9152 MHz × n multiplicative
- Reception Frequency = 15.6 MHz × n multiplicative
- Reception Frequency = 18.432 MHz × n multiplicative
- Upper Side (A-Band) Frequency = (Lower Side (B-band) Frequency ± 46.35 MHz) × n multiplicative
- Upper Side (A-Band) Frequency = (Lower Side (B-band) Frequency ± 47.25 MHz) × n multiplicative @
Upper Side (A-band) Mode = NFM

Symbol

 key	12
 key	12
 key	12
 key	12
 key	12
 switch	12
 switch	12
 key	12

A

Activating the GPS function	68
Adjusting the LCD backlight and keypad key light brightness level	107
Adjusting the LCD contrast level	106
Adjusting the microphone sensitivity	115
Adjusting the squelch level	37, 121
Adjusting the volume level	26
AF-DUAL function	77
All reset	39
AMS	32
AMS transmission mode	112
Analog FM mode	32
Antenna	6
Antenna terminal	12
APO function	127
APRS function	67
	*web
Assigning a name to a memory channel	47
Assigning name to memory bank	49
ATT function	109
Attaching a hand strap	16
Attaching the belt clip	15
Attaching the protective cap	15
Attenuator function	109

B

BACK TRACK function screen	74
Backtrack function	74
Band scope function	82
Battery approximate operating time	19
Battery case (FBA-39)	16
Battery Case 3x "AA" Cell (FBA-39)	146
Battery charger (PA-48B/C/U*)	146
Battery charger (SAD-11B; for USA market)	146
BCLO function	128
Before transmitting radio waves	11
Being called by the remote station (standby operation)	93
Bell	89
Belt clip	6
BNC-to-SMA adapter (CN-3)	146
Bundled items	6
Busy Channel Lockout function	128
BUSY/TX lamp	12

C

Calling a specific station	92
Calling only a specific station (new pager function)	90
Callsign	25
Canceling memory channel registration in memory bank	49
Canceling scanning	57
Changing home channel frequency	45
Changing the display pattern of the PO meter	109

Changing the frequency step manually	37
Changing the lighting condition	105
Changing the mode manually	38
Changing the number of times the bell rings	89
Changing the opening message displayed immediately after power-on	107
Changing the sound volume setting method	116
Changing the transmission power level	36
Charging the battery pack	17
Clock Type function	129
Clone cable (CT-168)	146
Clone operation	143
Communicating via the repeater	40
Communicating with a specific remote station	84
Communication mode	32
Confirming the entered DTMF code by the sound	80
Connecting the FT1DR/DE to external devices	145

D

Data Cable (2.5Φ) (CT-176)	146
Data cable (CT-170)	146
Data FR mode	32
DATA terminal	12
DC cable (E-DC-6)	146
DC cable w/ noise filter (SDD-13)	146
DCS	84
DCS code	86
DCS INVERSION function	119
Deleting a frequency registered to the skip search memory channel	58
Deleting memory channel	46
Digital communication	32
Digital mode	32
Disabling reception while no signal is received	136
Dismounting microSD memory card	23
Displaying memory tag	47
Displaying the GPS screen	103
Displaying the version of the DSP program	115
DTMF function	79
Dual reception function	75
DW	75
DW TIME function	124

E

Earpiece microphone (MH-37A4B)	146
Enabling no-communication squelch function	120
Enter the Set mode	94
EXT DC IN jack	12
External power supply	21
External power supply for use in vehicle	20

F

Flashlight (white LED)	12
Flow of operation to use the pager function	90
FM mode	32
Formatting a microSD memory card	24
Frequencies of international VHF (marine) radio	53
Frequency band for the A-band	29
Frequency band for the B-band	29
FT1DR/DE	6
FT1DR/DE Firmware Updates	144

*web: Please download the instruction manuals for GM function and APRS from our home page.

G

GM function65
 *web
 GPS68
 Group monitor function65
 *web

H

Home channel45
 Home channel dual reception76
 HOME VFO130

I

Input a call sign25
 Installing the antenna15
 Installing the battery pack17
 International VHF (marine) radio52
 IPX511

L

Listen to the international VHF (marine) radio52
 Listening radio broadcast with AF-DUAL reception function ...77
 Lithium ion battery packs (FNB-101LI, 7.4 V, 1100 mAh)146
 Lithium ion battery packs (FNB-102LI, 7.4 V, 1800 mAh)146
 LOCK function131
 Locking keys39
 Locking switches39

M

Measuring the battery voltage and the transceiver
 temperature108
 Memory bank link scan62
 Memory channel dual reception76
 Memory channel protect function118
 Memory channel scanning59
 Memory channel write function118
 Memory functions42
 Memory tag46
 Method of positioning by GPS70
 Microphone adapter (CT-44)146
 Microphone gain115
 microSD memory card22
 Mounting microSD memory card22
 Mute35
 Muting audio35
 Muting the key operation confirmation tone128

N

New pager function90
 Notification of a call from a remote station by the bell89
 Notification of call from the remote station by
 vibration of the vibrator88

O

Operating band27
 Optional parts146

P

Packet communication142
 Password function133
 PC connection cable (SCU-18 or SCU-19)6, 146
 Performing communication25, 31
 Performing programmable memory channel scan64
 Permitting transfer of home channel frequency to VFO130
 PMS63
 PMS memory channel63
 Positioning by GPS70
 Power cable20
 Power supply voltage measurement function108
 PR FREQUENCY function120
 Preset receiver memory channel51
 Preventing accidental transmission128
 Priority memory channel75
 Programmable memory channel63
 Programmable memory channel scan63
 Prohibiting registration to memory channel118
 Protective plate for battery pack6
 PTT DELAY function134

R

Rapid charger (CD-41)146
 Real-time navigation function73
 Recalling a memory channel44
 Recalling home channel45
 Recalling memory bank49
 Reception frequencies28
 Reception mode (radio wave type)38
 Reception Save function136
 Reducing receiver sensitivity109
 Register to a memory channel43
 Registering a memory channel in a memory bank48
 Registering CALLSIGN141
 Registering to a memory channel with the
 lowest memory channel number118
 Registering to a programmable memory channel63
 Registering your current position74
 Registering your favorite preset receiver
 memory channels in memory bank51
 Removing the battery pack17
 Repeater operation40
 Resetting the Set mode options94
 Restoring deleted memory channel46
 Restoring to defaults39
 Restricting the continuous transmission time136
 RPT ARS function134
 RPT SHIFT FREQ function135
 RPT SHIFT function135

S

S meter squelch function121
 Safety precautions7
 Saving/ Loading data to/from microSD memory card138
 Saving/ Loading GROUP ID information to/from
 microSD memory card139
 Saving/ Loading memory channel information
 to/from microSD memory card138
 SCAN LAMP function125
 SCAN RE-START function125
 Scanning a memory bank61
 Scanning function56
 Scanning only the selected memory channel61

Searching for signals with the signal strength graph	82
Searching for the frequency of the DCS used by the remote station.....	87
Searching for the frequency of the tone squelch used by the remote station.....	86
Select a tone squelch type	84
Selected memory channel	60
Selecting a band.....	29
Selecting a DCS code	86
Selecting a display language.....	106
Selecting a frequency band.....	29
Selecting a reception method when scanning stops	59
Selecting a tone frequency.....	85
Selecting an operating band.....	27
Selecting communication mode.....	32
Selecting vibrator operation mode.....	88
Sending a DTMF code manually	81
Sending the registered DTMF code.....	80
Set mode.....	94
Set mode option list.....	95
Setting clock time	34
Setting interval to save GPS position information	130
Setting memory bank link	117
Setting the ARS function.....	134
Setting the clock shift for the micro computer.....	129
Setting the code of your station.....	91
Setting the conditions for locking.....	131
Setting the direction for repeater shift.....	135
Setting the display method for BACKTRACK.....	104
Setting the display method of the remote station information.....	104
Setting the DTMF code.....	79
Setting the frequency selection range for operation in the VFO mode	137
Setting the operation of 	132
Setting the operation of Monitor key.....	132
Setting the optional microphone with camera for use.....	140
Setting the pop up time of the remote station information	112
Setting the PTT delay time	134
Setting the range for repeater shift.....	135
Setting the range for SCAN	126
Setting the resumption time of radio reception	78
Setting the search channels for the BAND SCOPE function.....	105
Setting the signal strength to output sound	121
Setting the sound and speed during tone search.....	123
Setting the squelch type for the digital mode.....	112
Setting the squelch type for transmission and reception	122
Setting the surveillance interval time for priority channels....	124
Setting the time signal	34
Setting the time to resume scan.....	124
Setting the transmission modulation level	110
Simultaneous radio broadcast reception	77
Simultaneous signal reception over the other frequency while listening to the radio	77
Skip memory channel.....	60
Skip search memory.....	57
Smart navigation function	73
Soft case (CSC-97)	146
Speaker / microphone (MH-34B4B)	146
Speaker Microphone with Snapshot camera (MH-85A11U)	82, 146
Specifying a selected memory channel.....	60
Specifying a skip memory channel.....	60
Specifying the frequency you do not want to scan	58
Split memory.....	44
SQL EXPANTION function	122
SQL LEVEL function.....	121
Squelch level.....	37
STANDBY BEEP setting.....	114
Switching between AM antennas.....	33
Switching between digital and analog mode	111

T

Taking picture	82
Taking picture with the optional camera mounted on speaker microphone	82
Temperature measurement function.....	108
Time signal tone	34
Timer function.....	132
Tone Calling (1750 Hz).....	40
Tone Search function.....	123
Tone squelch	84
TOT function.....	136
Transmission power level	36
Transmit and receive a DCS code with a inverted phase.....	119
Transmitting GPS data	144
Tuning in to a frequency	30
Turning illumination off when scanning stops	125
Turning off the BUSY indicator	129
Turning off the power automatically.....	127
Turning on the transceiver	25
Turning on/off the transceiver at the specified time	132

U

Usable microSD memory card.....	22
Using memory bank.....	48
Using the memory	42
Using the scanning function	56
Using the white LED as a flashlight	131

V

V/D mode.....	32
VFO dual reception.....	75
VFO MODE function	137
VFO scan.....	56
Vibrator	88
Vibrator operation mode	88
Voice FR mode.....	32
VOX headset (SSM-63A)	146

W

Worldwide short wave broadcast.....	54
-------------------------------------	----

Specifications

•General

Frequency Range

A (Main) Band RX:

0.5 ~ 1.8 MHz (AM Radio)
1.8 ~ 30 MHz (SW Radio)
30 ~ 76 MHz (50 MHz HAM: USA version)
30 ~ 88 MHz (50 MHz HAM: EXP/EU version)
76 ~ 108 MHz (FM Radio: USA version)
88 ~ 108 MHz (FM Radio: EXP/EU version)
108 ~ 137 MHz (Air Band)
137 ~ 174 MHz (144 MHz HAM)
174 ~ 222 MHz (VHF Band)
222 ~ 420 MHz (GEN1)
420 ~ 470 MHz (430 MHz HAM)
470 ~ 774 MHz (UHF Band: USA version)
470 ~ 800 MHz (UHF Band: EXP/EU version)
803 ~ 999 MHz (GEN2, Cellular Blocked: USA version)
800 ~ 999 MHz (GEN2: EXP/EU version)

B (Sub) Band RX:

108 ~ 137 MHz (Air Band)
137 ~ 174 MHz (144 MHz HAM)
174 ~ 222 MHz (VHF Band)
222 ~ 420 MHz (GEN1)
420 ~ 470 MHz (430 MHz HAM)
470 ~ 580 MHz (UHF Band)

TX:

144 ~ 146 MHz or 144 ~ 148 MHz
430 ~ 440 MHz or 430 ~ 450 MHz

Channel Steps:

5/6.25/8.33/9/10/12.5/15/20/25/50/100 kHz

Frequency Stability:

±2.5 ppm (–20 °C to +60 °C [–4 °F to +140 °F])

Emission Type:

F1D, F2D, F3E, F7W

Supply Voltage:

Nominal: 7.4 V DC (Negative Ground)

Operating:

4 – 14 V (Negative Ground, EXT DC JACK)
11 – 16 V (Negative Ground, EXT DC JACK with SDD-13)
7.4 V DC (Negative Ground)

Current Consumption:

150 mA (Mono band Receive)
220 mA (Dual band Receive)
100 mA (Mono band Receive, Standby)
150 mA (Dual band Receive, Standby)
45 mA (Mono band Receive, Standby, Saver On “Save Ratio 1:5”)
45 mA (Dual band Receive, Standby, Saver On “Save Ratio 1:5”)
+30 mA (GPS On)
+65 mA (Digital)
600 μ A (Auto Power Off)

Operating Temperature:

–20 °C to +60 °C [–4 °F to +140 °F]

Case Size (W × H × D):

60 × 95 × 32.5 mm (2.4" × 3.7" × 1.28") w/o knob & antenna

Weight (Approx.):

290 g (10.23 oz) with FNB-102LI & Antenna

•Transmitter

RF Power Output:	5 W (@ 7.4 V or EXT DC)
Modulation Type:	F1D, F2D, F3E: Variable Reactance modulation F7W: 4 FSK (C4FM)
Spurious Emission:	At least 60 dB below (@TX Power Hi, L3, L2) At least 50 dB below (@TX Power L1)

•Receiver

Circuit Type:	AM, NFM: Double-Conversion Super heterodyne AM/FM Radio: Single-Conversion Super heterodyne
Intermediate Frequencies:	1st: 47.25MHz (AM, NFM A Band) 1st: 46.35MHz (AM, NFM B Band) 2nd: 450 kHz (AM, NFM) 1st: 130 kHz (AM/FM Radio)
Sensitivity:	3 μ V for 10 dB SN (0.5 ~ 30 MHz, AM) 0.35 μ V TYP for 12 dB SINAD (30 ~ 54 MHz, NFM) 1 μ V TYP for 12 dB SINAD (54 ~ 76 (88) MHz, NFM) 1.5 μ V TYP for 12 dB SINAD (76 (88) ~ 108 MHz, WFM) 1.5 μ V TYP for 10 dB SN (108 ~ 137 MHz, AM) 0.2 μ V for 12 dB SINAD (137 ~ 140 MHz, NFM) 0.16 μ V for 12 dB SINAD (140 ~ 150 MHz, NFM) 0.2 μ V for 12 dB SINAD (150 ~ 174 MHz, NFM) 1 μ V for 12 dB SINAD (174 ~ 222 MHz, NFM) 0.5 μ V for 12 dB SINAD (300 ~ 350 MHz, NFM) 0.2 μ V for 12 dB SINAD (350 ~ 400 MHz, NFM) 0.16 μ V for 12 dB SINAD (400 ~ 470 MHz, NFM) 1.5 μ V for 12 dB SINAD (470 ~ 540 MHz, NFM) 3 μ V TYP for 12 dB SINAD (540 ~ 800 MHz, NFM) 1.5 μ V TYP for 12 dB SINAD (800 ~ 999 MHz, NFM, Cellular Blocked) 0.19 μ V TYP for BER 1% (Digital Mode)
Selectivity:	NFM, AM 12 kHz / 35 kHz (-6 dB / -60 dB)
AF Output:	200 mW (8 Ω for 10 % THD 7.4 V) 400 mW (8 Ω for 10 % THD 13.8 V)

Specifications are subject to change without notice, and are guaranteed within the 144/222 (USA version)/430 MHz amateur bands only.

1. Changes or modifications to this device not expressly approved by YAESU MUSEN could void the user's authorization to operate this device.
2. This device complies with part 15 of the FCC Rules. Operation is subject to the following two conditions: (1) This device may not cause harmful interference, and (2) this device must accept any interference including received, interference that may cause undesired operation.
3. The scanning receiver in this equipment is incapable of tuning, or readily being altered, by the User to operate within the frequency bands allocated to the Domestic public Cellular Telecommunications Service in Part 22.

Part 15.21: Changes or modifications to this device not expressly approved by YAESU MUSEN could void the user's authorization to operate this device.

DECLARATION BY MANUFACTURER

The Scanner receiver is not a digital scanner and is incapable of being converted or modified to a digital scanner receiver by any user.

WARNING: MODIFICATION OF THIS DEVICE TO RECEIVE CELLULAR RADIOTELEPHONE SERVICE SIGNALS IS PROHIBITED UNDER FCC RULES AND FEDERAL LAW.

Attention in case of use

This transceiver works on frequencies which are not generally permitted.

As for the actual usage, the user has to possess an amateur radio licence.

Usage is allowed only in the frequency bands which are allocated for amateur radios.

List of national codes					
AT	BE	BG	CY	CZ	DE
DK	ES	EE	FI	FR	GB
GR	HR	HU	IE	IT	LT
LU	LV	MT	NL	PL	PT
RO	SK	SI	SE	CH	IS
LI	NO	-	-	-	-

Disposal of your Electronic and Electric Equipment

Products with the symbol (crossed-out wheeled bin) cannot be disposed as household waste.

Electronic and Electric Equipment should be recycled at a facility capable of handling these items and their waste by products.

In EU countries, please contact your local equipment supplier representative or service center for information about the waste collection system in your country.





Yaesu UK Ltd
Unit 12, Sun Valley Business Park
Winnall Close
Winchester SO23 0LB
United Kingdom
Tel: +44 (0)1962 866667
Fax: +44 (0)1962 856801
Email: sales@yaesu.co.uk

Declaration of Conformity

Nr. YUK-DOC-0601-13

We, Yaesu UK Ltd. certify and declare under our sole responsibility that the following equipment complies with the essential requirements of the Directive 1999/5/EC and 2011/65/EU.

Type of Equipment	Dual Band Digital Transceiver
Brand Name	YAESU
Model Number	FT1DE
Manufacturer	YAESU MUSEN CO. LTD.
Address of Manufacturer	Tennozu Parkside Building, 2-5-8 Higashi-Shinagawa, Shinagawa-ku, Tokyo, 140-0002 Japan

Applicable Standards:

This equipment is tested to and conforms to the essential requirements of directive, as included in following standards:

Health 1995/5/EC Art.3 (1) (a)	EN 62311:2008
Safety 1995/5/EC Art. 3 (1) (a)	EN 60950-1:2006+A12:2011
EMC 1995/5/EC Art. 3 (1) (b)	EN 301 489-01 V1.9.2 EN 301 489-15 V1.2.1
Radio Spectrum 1995/5/EC Art. 3 (2)	EN 301 783-02 V1.2.1
ROHS2 2011/65/EU Art. 7 (b)	EN 50581:2012

The technical documentation as required by the Conformity Assessment procedures is kept at the following address:

Company
Address
Technical Construction file

Yaesu UK Ltd
Unit 12, Sun Valley Business Park, Winnall Close

Winchester, Hampshire UK SO23 0LB
Issued by: Yaesu Musen Co. Ltd, Tokyo Japan
File No: YETA00291
Drawn up in: Winchester, Hampshire UK
Date: 13th June 2013



Signed for and on behalf of Yaesu UK Ltd

Name and position:

PCJ Bigwood
Technical Sales Manager

YAESU

The radio

YAESU MUSEN CO., LTD.

Tennozu Parkside Building
2-5-8 Higashi-Shinagawa, Shinagawa-ku, Tokyo
140-0002 Japan

YAESU USA

6125 Phyllis Drive, Cypress, CA 90630, U.S.A.

YAESU UK

Unit 12, Sun Valley Business Park, Winnall Close
Winchester, Hampshire, SO23 0LB, U.K.

Copyright 2015
YAESU MUSEN CO., LTD.
All rights reserved.
No portion of this manual
may be reproduced
without the permission of
YAESU MUSEN CO., LTD.

Printed in Japan

1504V-EO



E H O 4 4 M 2 0 4